

Alex

SITS



Alex



designed by: Dan Ithreborn



UPHOLSTERY



fabric



leather

COMFOTS



STD standard

COVERS



FC fixed

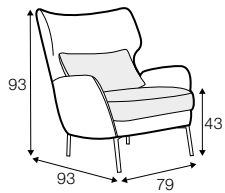

armchair

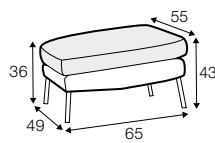

footstool 65x49

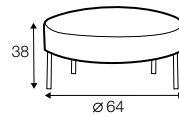

footstool round

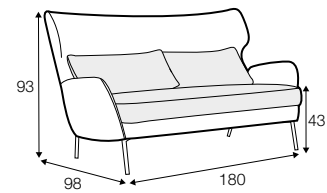

2,5 seater

accessories

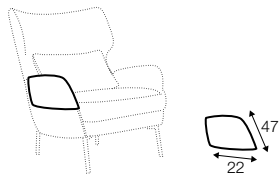

armrest protection

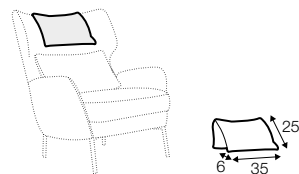

pillow

extra dimensions

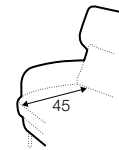

depth of
armchair seat

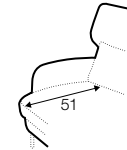

depth of
sofa seat

legs

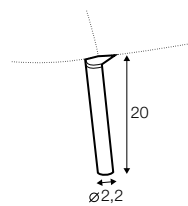

no. 160
metal chrome,
painted black
or brass gold
front: armchair,
footstool, sofa

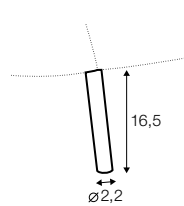

no. 160A
metal chrome,
painted black
or brass gold
back: armchair,
footstool

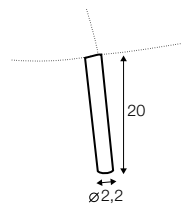

no. 160C
metal chrome,
painted black,
or brass gold
footstool round

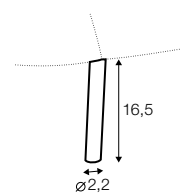

no. 160D
metal chrome,
painted black,
or brass gold
back: sofa

profile

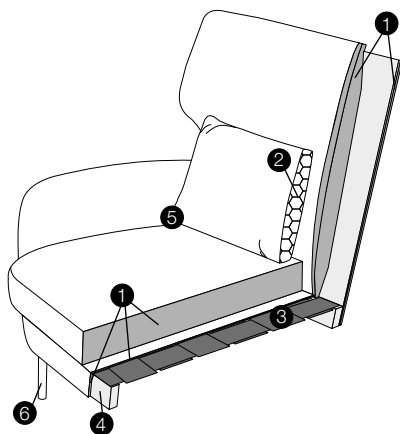

standard

1. polyurethane foam/high resilient polyurethane foam
2. silicone balls
3. upholstery belts
4. FSC® certified solid wood and wood based elements
5. fabric or leather
6. painted metal, chrom or brushed legs