

A CHIAN

SOMETH

BETTER





Our beautiful world is evolving,
and with it, so are we.

In the fluidity of life,
we are becoming more aware
of the amazing opportunities we have,
the choices we make,
and the footprint we leave behind.
Like the nature that surrounds us
we are finding new, exciting ways to grow,
to soften the fixed structures that restrain us,
to liberate our creativity
and to view our life, our work
and our world with new eyes.

Allowing us to follow our passions,
live by our values,
be exactly who we are,
and love who we want to love.

Inviting us to make a change
towards something better.

Welcome to the ever-changing,
the fluid and the free.







New Malin Modular Sofa. Designed by Says Who. Malin is a beautiful modular sofa with great comfort, created by the Danish design duo Says Who. With removable covers that can be dry cleaned or replaced if needed, the Malin sofa is designed to last for generations. Transform your Malin to fit your preferred expression by choosing one of the two options of cushions. Whether you prefer a clean and simple look or a luxurious, cosy lounge feel, Malin will make a beautiful centrepiece in your living space. Find possibilities for customisation on page 252.

New Malin Modular Sofa in Baize fabric, Sand. Designed by Says Who.







New Malin Modular Sofa in Baize fabric, Sand. Designed by Says Who.
Silhouette Cocktail Glass. Designed by Brido Design.



A change to something better

Today, we as consumers are more passionate than ever; passionate about the products we buy, where they come from, who makes them, from which materials they are crafted – and how long they last. Honesty, substance and longevity are topics that form the core of our decisions when we shop everything from fresh foods to a new sofa.

At Bolia, we are proud to be on an inspiring journey towards a more sustainable design industry and we are constantly experimenting and getting better at what we do. Learning new ways to improve and to reduce our footprint.

We now use left-over and waste materials in more designs than ever before. In our fabrics, foams, rugs and plastic components. Breathing new life into used resources.

For instance, the seat of our Seed chair series is made from recycled plastics. Its oak legs are made in sustainable wood from responsible forestry – FSC® certified, like every piece of wood in our collection.

All our rugs are beautifully handwoven and labelled Care & Fair. An initiative created to support local weavers and their families, ensuring that the traditional craft lives on, while securing responsible working conditions and access to health care and education.

We are empowering and supporting all our wonderful colleagues and partners around the world, and as part of amfori BSCI we follow the BSCI code of conduct, ensuring the social rights and safety of everyone involved in our design universe.

We also work closely with the innovative Danish company MÅLBAR to analyse the climate footprint of a design throughout its life cycle – from raw material, to production, packaging and shipping, its use and eventual disposal. Empowering us to find ways to improve and you to make mindful decisions.

What we believe matters the most is extending product longevity, by making beautifully timeless designs from carefully selected and certified materials, crafted to last for generations. That is why we are happy to give a 10-year warranty on every single design in our collection. See the terms and conditions on [Bolia.com](https://www.bolia.com).



Cosima Modular Sofa. Designed by *kaschkasch*.

Cosima is a soft and embracing modular sofa designed by the Cologne-based design duo, *kaschkasch*. The sofa is characterised by its eye-catching lounge aesthetic and low arm and backrest, which offers the ultimate invitation to relax and unwind. On the inside, Cosima is made of FSC® certified wood and filled with a plush down and feather filling that is sewn into channels to extend durability and secure the iconic shape. Cosima can be designed specifically to fulfil your dreams and needs, in two different seat depths, and you can remove or add modules whenever new needs arise. Find possibilities for customisation on page 244-245.



Cosima Modular Sofa in Monza bouclé, Beige. Designed by *kaschkasch*. Story Coffee Table & Side Table. Designed by *Anna Karnov & Clara Mahler*. New Bowie Armchair in Vilme bouclé, Beige. Designed by *Skrivo*. New Zen Rug. Designed by *Studio Emily Broom*.





Cosima Modular Sofa in Monza bouclé, Beige. Designed by *kaschkasch*.
Story Side Table. Designed by *Anna Karnov & Clara Mahler*.
New Bowie Armchair in Vilme bouclé, Beige. Designed by *Skrivo*.

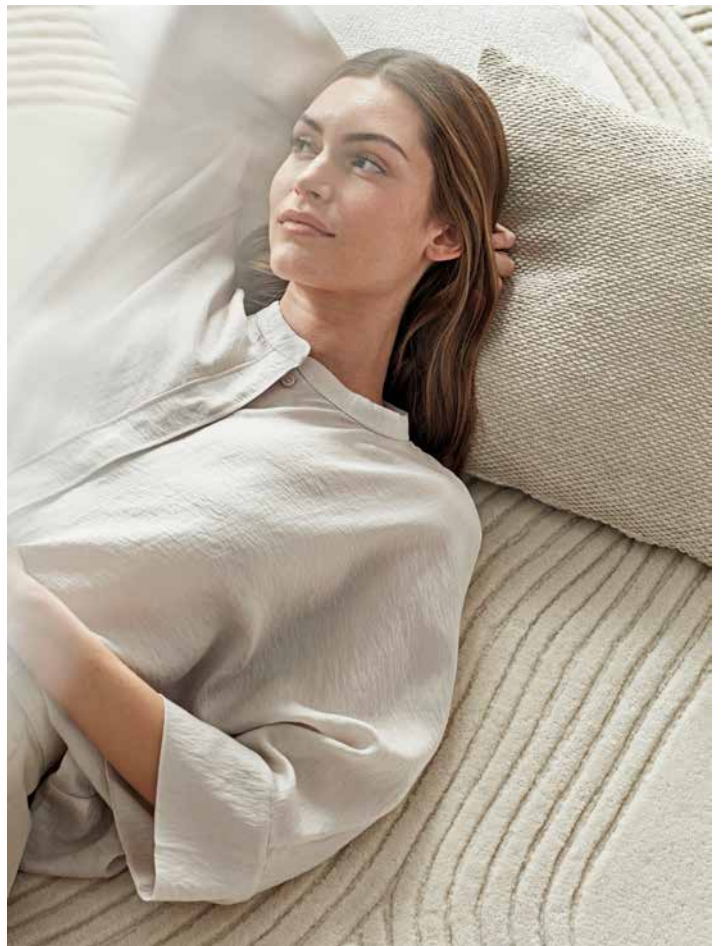

Classic Cushions. Designed by *Bolia Design Team*.
New Zen Rug. Designed by *Studio Emily Broom*.

Bowie Armchair

Designed by Skrivo



Influenced by mid-century Scandinavian design and designed by Italian Skrivo. A sophisticated armchair characterised by a luxurious oak frame that seamlessly widens from leg into armrest, gently embracing the seat. Handcrafted with a combination of traditional and modern woodworking techniques which lend a contemporary aesthetic to the design.

The plush seat and backrest are upholstered in one of our STANDARD 100 by OEKO-TEX® fabric or LEATHER STANDARD by OEKO-TEX® certified leathers.

Skrivo was founded by the Croatian and Irish industrial designer Stefan Krivokapic. His multicultural background has always guided him to take bits and pieces of different cultural habits, history, values and mate-

rials to create interesting and innovative designs. At the heart of every project, is the idea of starting from a material or crafting technique in order to arrive at stimulating and timeless solutions. Always conscious of the available manufacturing methods and innovative material research to create products that balance function and aesthetics – exactly like Bowie does.





Fusion Dining Table. Designed by *Michael H. Nielsen*.

Fusion dining table combines soft lines with a robust construction of solid FSC® certified wood. Designed to emulate the precision of a compass, circles are the common denominator in this beautiful dining table, where the legs break the table top's clean expression. Fusion can also be extended, enabling it to seat four extra guests.



Fusion Dining Table. Designed by *Michael H. Nielsen*. New Kite Chair. Designed by *Studio Nooi*.
New Acorn Pendant. Designed by *365° North*.



Bronco Vase.
Designed by *Fabio Vogel*.
Forma Dinner Plate & Bowl.
Designed by *Ferriani Sbolgi*.
Fluent Cutlery.
Designed by *Yonoh Creative Studio*.
Soft Collection Napkin.
Designed by *Bolia Design Team*.





*New Kite Chair. Designed by Studio Nooi.
Fusion Dining Table. Designed by Michael H. Nielsen.*







Forma Flowerpot. Designed by *Ferriani Sbolgi*.
Hour Vases. Designed by *201 Design Studio*.





New Scandinavian Design

At Bolia, we believe great design is not only what meets the eye, but just as importantly, how it is created – and the way it makes us feel. Calm. Balanced. Revitalised.

From the first sketches to the final product, every design in our collection is designed to last. Handmade by some of Europe's best manufacturers and crafted from the finest and most durable materials, blessed to us by nature.

Designed for customisation, inspiration, and decades of life. This is how we pay tribute to our Scandinavian design heritage – and to the natural landscapes and materials that surround us.

We believe that fresh perspectives pave the way for change, and that creativity thrives on diversity, curiosity, openness, and collaboration. That is why our collection is created by a brilliant community of designers from around the world – with a shared passion for sustainable solutions and New Scandinavian Design.

Every year, we honour the brightest talents of our industry at the Bolia Design Awards. A grand tradition established more than 15 years ago which not only supports and opens exciting doors for brave new designers, but also helps us see things in a new light, find new ways and make changes for the better.

Several of the winning designs have made their way into our collection with royalty of sales to each talented designer – and the beginning of a thriving collaboration.



Elton Sofa Series. Designed by *Glismand & Rüdiger*.

Elton, designed by Glismand & Rüdiger, is a beautiful and timeless series of sofas, armchairs, poufs and daybeds. With its clean silhouette, surrounded by the slim oak frame, Elton rises above the ground and allows every tailored component and craftsmanship detail to be visibly exposed in its most honest form. The light 30 mm solid wooden frame seems to almost float, elevated underneath the inviting cushions. Elton's interior is constructed with a special metal frame and fibreglass reinforced nylon slats, which lifts the furniture and ensures optimal comfort. The sofa has reversible back cushions, filled with the innovative Fossflakes, which is a hypoallergenic, down-like filling that keeps its shape longer than conventional down filling. Each of the sofa's components is interchangeable as the years progress, in order to extend the lifetime as far as possible.

Find possibilities for customisation on page 248.





Elton 3 Seater Sofa in Vilme bouclé, Sand. Designed by *Glismand & Rüdiger*. Elton Armchair in Soil recycled fabric, Sand. Designed by *Glismand & Rüdiger*. Berlin Coffee Table. Designed by *Hertel & Klarhoefer*. New Friedman Storage Series. Designed by *Adam Friedman*. New Acorn Pendants. Designed by *365° North*.



Elton Sofa Series

Designed by Glismand & Rüdiger



A powerfully timeless silhouette, echoing the legacy and careful craftsmanship of the Scandinavian design tradition. The Elton series comprises of elegant sofas, armchairs, poufs and daybeds, all characterised by a slim frame, handcrafted in solid wood that gracefully elevates the inviting seat. A series by the Danish design duo Glismand & Rüdiger.

For the designers, Scandinavian design is not a branding label, but a commitment.

Something to be interpreted in contemporary ways, and something to be proudly honoured. They are passionate about sustainability and design with longevity as the starting point. Resulting in beautiful pieces that are built to last for generations.

With its clean silhouette Elton rises above the ground, allowing every tailored component and crafted detail to be visibly exposed in its honest form. And as your Elton ages over time, every single component in the

design can be replaced, if needed. Truly a long-lasting companion, both by its timeless aesthetic and by its handcrafted build.

Customise your Elton with your choice from our collection of tactile and durable fabrics, all of which are STANDARD 100 by OEKO-TEX® certified, or LEATHER STANDARD by OEKO-TEX® leathers.



Una Vases. Designed by *Kateryna Sokolova*.
Berlin Coffee Table. Designed by *Hertel & Klarhoefer*.



New Acorn Pendants. Designed by *365° North*.



New Friedman Storage Series. Designed by Adam Friedman.

Graceful Table & Bench Series

Designed by Michael H. Nielsen



The Graceful series is made to last for years – maybe even a lifetime. It is a beautiful series of dining tables with matching benches, coffee tables and desks, designed by Danish Michael H. Nielsen in nature's best and most durable materials.

Characterised by sleek lines, aesthetic angles and solid, FSC® certified wood that invites you to feel its fine, natural structures.

With his inquisitive nature and creative approach to design, materials and sustainability, Michael H. Nielsen created the Graceful series based on a 'less is more' principle. Details are kept to the bare minimum, allowing each design to speak its very own distinctive language. All designs in the series are characterised by a tactile, unbroken wooden surface that subtly embraces the natural aesthetics of the design.

A timeless and elegant interpretation of our Scandinavian design heritage that tells a story of great craftsmanship and most importantly – longevity.







Graceful Dining Table. Designed by Michael H. Nielsen. New Graceful Bench. Designed by Michael H. Nielsen.
New Neutra Shelving System. Designed by Arnau Reyna Estudio. New Acorn Pendants. Designed by 365° North.
Vilde Rug. Designed by Bolia Design Team.

Arcs Tableware Series. Designed by Büro Famos.
Forma Tableware Series. Designed by Ferriani Sbolgi.
New Rheolog Glass Series. Designed by jüngerkuhn.
Fluent Cutlery. Designed by Yonoh Creative Studio.
Soft Collection Napkins. Designed by Bolia Design Team.





*New Forma Flowerpots. Designed by Ferriani Sbolgi.
Grove Flowerpot. Designed by Anna Karnov & Clara Mahler.*





New Veneda Sofa Series

Designed by *Bolia Design Team*.

Veneda is a beautiful and timeless series of sofas and poufs. With a luxurious combination of down and foam filling, it is incredibly soft and inviting, yet designed with a simple expression to exceed fleeting trends and tendencies. Veneda's cover is completely removable, which is another great quality ensuring a long lifetime, being able to adapt the sofa to changing needs and wishes. Its deep seats create an exclusive lounge aesthetic that stands in elegant contrast to the classic design language. A design that refuses to compromise on comfort, elegance or quality. Find possibilities for customisation on page 249.





New Veneda 4 Seater Sofa in Ascot bouclé, Beige. Designed by Bolia Design Team. Plateau Coffee Table. Designed by Büro Famos. Campa Floor Lamp. Designed by Spant Studio. New Brida Rug. Designed by Bolia Design Team.



Classic Cushions. Designed by *Bolia Design Team*.





Forma Vase & Tableware Series.

Designed by *Ferriani Sbolgi*.

New Veneda 4 Seater Sofa in Ascot bouclé, Beige.

Designed by *Bolia Design Team*.





Graceful Dining Table. Designed by *Michael H. Nielsen*.

Designer Michael H. Nielsen created the Graceful series based on the motto 'less is more'. The details are kept to a minimum, allowing each design to speak its own distinctive language. The series includes different beautiful tables such as desks, dining tables and coffee tables, and they all share the characteristic unbroken surface that and minimal design language. Graceful is FSC® certified and is available in several sizes, shapes and formats with different functions.



Graceful Dining Table. Designed by *Michael H. Nielsen*. Swing Dining Chair. Designed by *Henrik Sørig Thomsen*.
Orb Lounge Pendant. Designed by *365° North*.





Graceful Dining Table. Designed by *Michael H. Nielsen*.
Swing Dining Chair. Designed by *Henrik Sørig Thomsen*.
Orb Lounge Pendant. Designed by *365° North*.
Forma Tableware. Designed by *Ferriani Sbolgi*.
Carved Cutlery. Designed by *Yonoh Creative Studio*.

Swing Chair

Designed by Henrik Sørig Thomsen



The Swing Chair is designed by the talented Danish designer Henrik Sørig Thomsen with the ambition of creating a simple design classic that supports everyday life in the most beautiful way. Designed and built to last in solid, oiled oak – crafted and refined by hand using traditional woodworking techniques and tested to meet the highest quality standards.

As something very special, Swing is both FSC® certified and the unupholstered version carries the EU Ecolabel – the official European certificate for products that have a lower environmental impact and contribute to sustainable development along their life cycle. While being durable and repairable. Allowing you to make conscious choices, without compromising on the quality of the products.

Swing can be upholstered in elegant leathers – LEATHER STANDARD by OEKO-TEX® certified and 100% traceable – or fabrics in a variety of elegant colours and textures to fit any space.







Noora Modular Sofa.

Designed by *Bolia Design Team*.

The elegant design of the Noora series gives you a modular sofa that combines excellent craftsmanship with aesthetics and luxurious comfort. Constructed from FSC® certified wood and upholstered in STANDARD 100 by OEKO-TEX® certified fabrics. A sofa with a simple look and fine, handmade details that highlight the exquisite quality of the craft. Made to last. Find possibilities for customisation on page 246-247.





Noora Modular Sofa in Monza bouclé, Sand. Designed by *Bolia Design Team*. Como Coffee Table. Designed by *Glismand & Rüdiger*.
New Bowie Armchair in Soil recycled fabric, Sand. Designed by *Skrivo*.



Como Coffee Table in travertine.
Designed by *Glismand & Rüdiger*.
Falda Candleholder.
Designed by *Ferriani Sbolgi*.





New Noora Rounded Module in Monza bouclé, Sand. Designed by Bolia Design Team.







Noora Modular Sofa in Vilme bouclé, Beige. Designed by *Bolia Design Team*.
New Graceful Coffee Table. Designed by *Michael H. Nielsen*.
Campa Table & Floor Lamp. Designed by *Spant Studio*.
Dalvik Rug. Designed by *Bolia Design Team*.



New Forma Candleholder. Designed by *Ferriani Sbolgi*.

Yacht Dining Table Series. Designed by *Glismand & Rüdiger*.

When exceptional effort is put into wood crafting and combined with Scandinavian sensibility, the results are bound to be stunning. This was the creative outset when the Danish design duo, Glismand & Rüdiger, made the Yacht series – starting with a breathtakingly simple and straightforward dining table. The series includes tables in different sizes and high boards all featuring crafted details and beautiful carpentry. A series of understated yet completely spectacular furniture.

Yacht Table. Designed by *Glismand & Rüdiger*.

New Apelle Chair. Designed by *Busetti Garuti Redaelli*.

New Campa Pendant. Designed by *Spant Studio*.





New Apelle Chair. Designed by Busetti Garuti Redaelli.



*Arcs Tableware Series.
Designed by Büro Famos.
Soft Collection Napkin.
Designed by Bolia Design Team.*



Campa Lamp Series

Designed by Spant Studio



Spant Studio is a Danish architecture studio based in our home town, Aarhus – and the designers behind the Campa lamp series.

A collection of lamps with a distinctive and elegantly shaped silhouette, in fluted opal glass, and beautiful, handmade details

in wood. The series spans from floor and table lamps to a stunning pendant with an impressive shade in 50 cm diameter.

The idea behind the design was to create simple lighting without too many components, that would still be eye-catching.

The light source and shape have been carefully designed to do just that. The shade contour creates a downward light and the semi-transparent glass emits a beautifully diffuse light.

In short; a timeless classic, made to last.

Inspiring spaces

Home. Our private nest, our silent retreat and our soul space. Not merely a place of shelter and rest; our home sets the scene for love and friendship, family time and togetherness. It is a fluid space for fine dining, playfulness and entertainment, workouts and spa treatments, cosy book reading, gardening and secret hobbies. A place where mindful rituals can unfold – and where education, work and business ventures prosper.

Our home is a projection of ourselves. Sensuous, inspiring, active and unique.

In beautiful and natural spaces, our well-being and creativity flourishes, and we enjoy exciting newness and change. At the same time, we hurt when resources go to waste. Therefore, we invite nature inside and strive for sustainability, quality and lasting designs crafted from natural materials, with a timeless and calming aesthetic.

We love the luxury of slowness and reflection – and our senses grow sharper with every touch, as we reconnect with the tactility of honest materials like solid wood, elegant stones, natural fabrics and leathers, soft wool and muted colours. Becoming only more beautiful with every changing season.

A home in which we can breathe, grow, thrive and love.





New Malin Modular Sofa. Designed by Says Who.

Malin is a series of beautiful modular sofas with great comfort, created by the Danish design duo Says Who. With removable covers that can be dry cleaned or replaced if needed, the Malin sofa is designed to last for generations. Transform your Malin to fit your preferred expression, by choosing one of the two options of cushions. Whether you prefer a clean and simple look or a luxurious lounge feel, Malin will make a beautiful centrepiece in your living space.

Find possibilities for customisation on page 252.



New Malin Modular Sofa in Baize fabric, Sand. Designed by Says Who. Cosh Armchair in Monza bouclé, Beige. Designed by Kateryna Sokolova. Como Coffee Table. Designed by Glismand & Rüdiger. Funo Rug. Designed by Bolia Design Team.

New Malin Modular Sofa
in Baize fabric, Sand.
Designed by Says Who.





Como Coffee Table in travertine.
Designed by *Glismand & Rüdiger*.



Frame Away Series.
Designed by *Bolia Design Team*.



Alp Dining Table & Bench. Designed by *Ramos Bassols*.

Alp is designed by the Spanish design duo, Ramos Bassols, and is an exclusive series of dining tables and benches. The designers wanted to let the clean and graphic lines take centre stage and offer simplicity with surprising detail. All designs are crafted from FSC® certified wood with an understated and natural expression, pointed out by the architectural contours, crafted details and blunt yet delicate design language. Detail by detail.



Alp Dining Table & Bench. Designed by *Ramos Bassols*. Grove Flowerpot. Designed by *Anna Karnov & Clara Mahler*.





Alp Dining Table & Bench. Designed by *Ramos Bassols*.
Forma Tableware. Designed by *Ferriani Sbolgi*.









Cosima Modular Sofa

Designed by kaschkasch



Soft, embracing and spacious enough for any sized dream to grow and flourish. The Cosima modular sofa is characterised by its extra seat depth and low arm and backrests, which invite you to slow down, sit back and breathe, while comfortably knowing that your sofa is thoughtfully crafted from natural materials, and made to last.

Designed by the Cologne-based design studio kaschkasch, the Cosima sofa combines

functional German design with Scandinavian comfort and simplicity. The duo strives to create beautifully intuitive, uncomplicated design – simple shapes and clean lines, that possess a poetic expression.

On the inside, Cosima is built by hand in FSC® certified wood and filled with real down and feather that is sewn in channels to extend durability and shape. On the outside, the look and feel is up to you.

Designed by you, for you, as you combine and arrange any modules you need and decide upon the fabric from our collection that best suits your lifestyle and aesthetic.

Cosima modules come in two different seat depths and can be rearranged, added or removed over time, as life presents you with new needs and possibilities.



Cosima Modular Sofa. Designed by *kaschkasch*.

Cosima is a soft and embracing modular sofa, designed by the Cologne-based design duo, kaschkasch. The sofa is characterised by its extra seat depth and low arm and backrest, which gives Cosima an inviting appearance. Cosima is made of FSC® certified wood and filled with real down and feather that has been sewn in channels to extend the durability and shape. Cosima can be designed specifically to fulfil your dreams and needs, and you can remove or add modules in two different seat depths whenever new needs arise.

Find possibilities for customisation on page 244-245.



Cosima Modular Sofa in Vilme bouclé, Sand. Designed by *kaschkasch*. New Latch Coffee Table. Designed by *Dazingfeelsgood*. Orb Pendants. Designed by *365° North*. New Zen Rug. Designed by *Studio Emily Broom*.



Classic Cushion Series. Designed by *Bolia Design Team*.
Cosima Modular Sofa in Vilme bouclé, Sand. Designed by *kaschkasch*.







*New Visti Armchair in Monza bouclé, Sand. Designed by Studio Nooi.
Story Side Table. Designed by Anna Karnov & Clara Mahler.
New Zen Rug. Designed by Studio Emily Broom.*



Orb Pendants. Designed by 365° North.

Zen Rug Series

Designed by Studio Emily Broom



A series of handmade, organically shaped rugs with a creative and calming design language. The design is inspired by the Japanese zen gardens and the idea of making our homes into peaceful sanctuaries of self-reflection and inner calm.

Just like these beautiful gardens are intended to represent the various calming elements in nature and aid in contemplation and meditation, the Zen rug series has been created to bring a grounding foundation into our homes and improve everyday life through

simple, uncluttered lines and soft, durable materials. To bring a natural, down-to-earth foundation inside and to create soothing feelings of well-being and immersion, while inviting you to close the door to the busy world behind you. At least for a moment.

The talented Copenhagen-based, Australian designer, Emily Broom, won Bolia Design Awards 2020 with Zen. Meaningful design solutions are her passion, and with each new project she sees the opportunity to explore the fine balance of practicality and sophis-

tication. Her focus is on tactility, form and composition and with every design, she pays close attention to traditional craftsmanship and longevity.

All our rugs are beautifully handwoven and labelled Care & Fair. An initiative created to support local weavers and their families, ensuring that the traditional craft lives on, while securing responsible working conditions and access to health care and education.



New Track Dining Table Series. Designed by Studio Nooi.

The Track dining table is designed by Italian Studio Nooi. Crafted with a combination of luxurious, FSC® certified solid oak and a minimalist metal frame for a light and understated look. The extension leaves are designed to be a beautiful and dramatic addition to the design – the arcs gracefully linking the two planks when in use. A dining table with refined proportions and details, built to last, with exceptional stability and durability.





New Track Table. Designed by Studio Nooi. New Kite Chair. Designed by Studio Nooi. New Balloon Pendants. Designed by Meike Harde.



Forma Vases. Designed by Ferriani Sbolgi.



*New Balloon Pendants.
Designed by Meike Harde.*

Forma Tableware Series. Designed by *Ferriani Sbolgi*.
Taper Glass Series. Designed by *jüngerkuhn*.
Fluent Cutlery. Designed by *Yonoh Creative Studio*.
New Soft Collection Napkin. Designed by *Bolia Design Team*.







Scandinavia Remix Sofa Series. Designed by *Glismand & Rüdiger*.

The Scandinavia Remix sofa is a modern classic, designed by Glismand & Rüdiger. Its frame is made in solid, FSC® certified wood from European forestry, and beneath the beautiful simplicity and minimal lines the design has a wealth of hidden features that ensure outstanding comfort and durability. For instance, the armrests have generous padding for superior comfort and the cushions are reversible, as they are upholstered on both sides, and available in your choice of either down or foam filling for a softer or firmer feel. Under the seat cushions you will find a slightly elevated edge which keeps the cushions in place. The legs are available in several different materials and in two heights. A sofa with a classic, timeless quality that can be passed on through generations.

Find possibilities for customisation on page 242-243.





Scandinavia Remix Sofa in Monza bouclé, Sand. Designed by *Glismand & Rüdiger*. New Visti Armchair in Soil recycled fabric, Sand. Designed by *Studio Nooi*. Mix Coffee Table. Designed by *Studio Gud*. Reflection Floor Lamp. Designed by *Asger Risborg Jakobsen*.



Scandinavia Remix Sofa in Monza bouclé, Sand.
Designed by *Glismand & Rüdiger*.



Mix Coffee Table. Designed by *Studio Gud*.
Arcs Tableware Series. Designed by *Büro Famos*.
Hour Vase. Designed by *201 Design Studio*.

Scandinavia Sofa Series

Designed by Glismand & Rüdiger



The Scandinavia series is a beloved classic, designed by Glismand & Rüdiger. Made with a fully removable cover that gives you the freedom to adjust your aesthetic and needs over time as well as extend the lifetime of your sofa significantly.

Its frame is made in solid, FSC® certified wood and beneath the elegant surface the design has a wealth of hidden features that ensure outstanding comfort and durability. For instance, the armrests have generous padding and the cushions are reversible, as they are upholstered on both sides, and available in your choice of either down and feathers or foam filling for a softer or firm-

er feel. Under the seat cushions you will find a slightly elevated edge which keeps the cushions in place. The legs are available in different materials and in two heights.

The Scandinavia series also include a sofa bed with an easy fold-out mechanism that allows you to transform it into a comfortable bed for your guests in just a single movement. The reinforced bed base ensures the same level of comfort as a proper bed and with the matching pouf with hidden storage, you can hide away bedding.

If you prefer the lighter look and a sleeker frame, Glismand & Rüdiger has created

Scandinavia Remix – a reinterpretation of the classic Scandinavia, designed to add a modern touch to the series without compromising on function, aesthetics or durability. Scandinavia Remix also comes as an elegant daybed and armchair.

The design duo shares our passion for Scandinavian design and natural materials. And longevity is the starting point for every new creation in their portfolio – all the way from the first sketches to the final product. Designing beautiful pieces that are built to last, with classic, timeless qualities that can be passed on through generations.



*New Scandinavia 3 Seater Sofa in Vilme bouclé, Light Grey. Designed by Glismand & Rüdiger.
Scandinavia Remix Armchair in Vilme bouclé, Light Grey. Designed by Glismand & Rüdiger.
New Como Coffee Table. Designed by Glismand & Rüdiger. Luxe Sideboard. Designed by Michael H. Nielsen.
New Acorn Pendant & Table Lamp. Designed by 365° North. Funo Rug. Designed by Bolia Design Team.*





Bronco Vase. Designed by *Fabio Vogel*.





Classic Cushion Series. Designed by *Bolia Design Team*.
New Zyl Pouf. Designed by *Glismand & Rüdiger*.



New Scandinavia Sofa with removable
cover in Vilme bouclé, Light Grey.
Designed by *Glismand & Rüdiger*.

The Scandinavia, Malin and Veneda sofa series all come with fully removable covers – ensuring easy cleaning and a long lifetime, while giving you the possibility to adapt your sofa to changing needs and wishes over time.

Scandinavia Sofa Bed. Designed by *Glismand & Rüdiger*.

Scandinavia sofa bed gives you the comfort of a bed disguised as a sofa. The appearance is distinctly Scandinavian, while the inside features a fold-out mechanism made of the highest quality. Not only is the mechanism soundless, durable and easy to handle, it also reveals a top-quality mattress with a length of 210 cm. The reinforced bed base ensures the same level of comfort as a proper bed. Add the matching pouf to hide the bedlinen away in the pouf's hidden storage compartment. The Scandinavia sofa bed is available in countless fabric and colour combinations, just like the classic Scandinavia sofa – with a fully removable cover too. Find possibilities for customisation on page 240-241.

Scandinavia Sofa Bed in Memory bouclé, Light Grey. Designed by *Glismand & Rüdiger*.

Scandinavia Pouf. Designed by *Glismand & Rüdiger*.



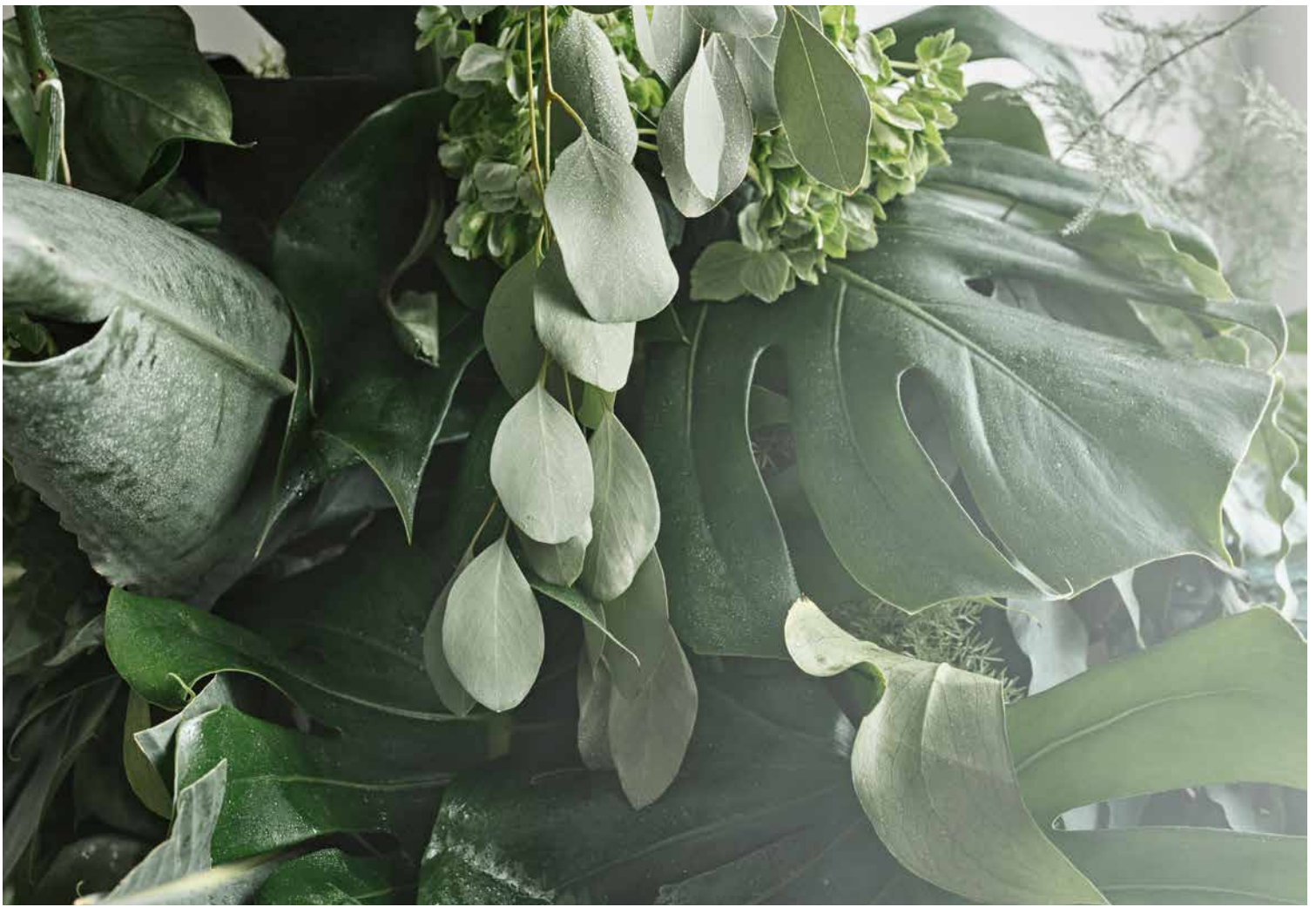

Soft Collection Bed Linen. Designed by *Bolia Design Team*.
Racquet Mirror. Designed by *Oliver Schick*.





New DoubleUp Table. Designed by Michael H. Nielsen.
A dining table made with superb craftsmanship with a concealed fold-out extension leaf. In one elegant move, the tabletop folds out to extend into double its original size. Every part of the design is skilfully finished with fine detailing, revealing its handcrafted nature. The perfect dining table for smaller spaces, when you will not compromise on quality, aesthetics – or the number of dining guests.



*New DoubleUp Table. Designed by Michael H. Nielsen.
Tune Chair. Designed by Henrik Sørig Thomsen.
Natura Rug. Designed by Bolia Design Team.*



Arcs Tableware Series.
Designed by Büro Famos.



*New DoubleUp Table. Designed by Michael H. Nielsen.
Tune Chair. Designed by Henrik Sørig Thomsen.
Natura Rug. Designed by Bolia Design Team.*



Acorn Lamp Series

Designed by 365° North



The Acorn pendant and table lamps share an appealing, organic silhouette – inspired by the characteristic shape of an acorn. The lamps are made in FSC® certified oak

and either white opal glass or delicately transparent fabric with the cord seamlessly integrated into the design. The material contrast of opal glass or fabric and oiled

oak makes the lamps equally appealing switched on or off. Designed by the Danish design studio 365° North.





New Caro Sofa Series. Designed by kaschkasch.

The Caro sofa series of sofas and poufs is a reinterpretation of a classic, designed by the Cologne-based design duo, kaschkasch. Its curved arm- and backrest provide superior comfort, as well as adding an elegant and organic look to the design. The frame is made from durable, FSC® certified wood and with its firm cold foam filling it is easy to maintain, keeping the expression elegantly precise. It is tested to meet the highest quality standards and will remain a beautiful centrepiece in your interior for years to come.

Find possibilities for customisation on page 251.



*New Caro 5 Seater Sofa with open end in Revi recycled fabric, Ivory. Designed by kaschkasch.
New Tab Coffee Table. Designed by Busetti Garuti Redaelli. New Acorn Pendants. Designed by 365° North.
New Brida Rug. Designed by Bolia Design Team.*



*New Graceful Bench. Designed by Michael H. Nielsen.
New Forma Flowerpot. Designed by Ferriani Sbolgi.*



*New Caro Sofa in Revi recycled fabric, Ivory.
Designed by kaschkasch.*







New Rheolog Champagne Bowl & Glass Series. Designed by jüngerkuhn.
Arcs Tableware Series. Designed by Büro Famos.
Soft Collection Napkin. Designed by Bolia Design Team.









Lomi Sofa Series

Designed by Meike Harde



A beautiful combination of distinctive lounge aesthetics and the rigorous Scandinavian design universe. Lomi is a series of sofas and poufs designed by German Meike Harde with a robust interior in FSC® certified wood, beautifully embraced by soft inviting cushions and your favourite STANDARD 100 by OEKO-TEX® certified fabric or traceable leather.

The clean lines of the legs and frame are precisely positioned to add a touch of elegance and lightness, while the more characteristic shapes and features enhance Lomi's exclusive craftsmanship. A timeless design that will make a comfortable centerpiece in your home for many years.

Meike Harde creates design that is characterised through fine structures, a certain tactility and subtle details adapted in pure shapes. Designs that aim towards an aesthetic synergy of material and form. She believes decorative elements should walk hand in hand with a useful purpose. Because to her, function and aesthetic are a unified whole.

Lomi Sofa Series. Designed by *Meike Harde*.

German Meike Harde's intention with Lomi was to combine distinctive lounge aesthetics with the more stringent Scandinavian design universe. The result is a sofa where the cushions are positioned on a base with no-zag springs that are connected closely together to provide exceptional comfort. The legs and frame are precisely positioned to add elegance and lightness to the sofa, while the interior construction in FSC® certified wood and the inviting armrests enhance the design's craftsmanship properties.

Find possibilities for customisation on page 250.

Lomi 3 Seater Sofa in Baize fabric, Dark Beige. Designed by *Meike Harde*.

Mix Coffee Table. Designed by *Studio Gud*.

New Balloon Pendants. Designed by *Meike Harde*.

Alve Rug. Designed by *Bolia Design Team*.

Forma Vases & Flowerpots. Designed by *Ferriani Sbolgi*.





Forma Vase. Designed by *Ferriani Sbolgi*.
Mix Coffee Table in travertine. Designed by *Studio Gud*.





Lomi 3 Seater Sofa in Baize fabric, Dark Beige.
Designed by *Meike Harde*.
Mix Coffee Table.
Designed by *Studio Gud*.
Classic Cushion Series.
Designed by *Bolia Design Team*.



Story Table Series

Designed by Anna Karnov & Clara Mahler



The Story series is a beautiful reinterpretation of side-, coffee-, and bar tables in FSC® certified wood that tells a captivating story of creative craftsmanship and distinctive design language. The airy front composed of repeated stick in solid oak

delicately hides the clutter of everyday life. The designers behind Story, Anna Karnov & Clara Mahler, intended to create a design with a durable quality that ages gracefully while continuously accommodating to changing wishes and needs.

A design that channels its Scandinavian simplicity in a harmonious new interpretation; uniting function, format and aesthetics in an effortless and elegant way.





*New Veneda Corner Sofa in Revi recycled fabric, Light Grey. Designed by Bolia Design Team.
Como Coffee Table. Designed by Glismand & Rüdiger. Graceful Dining Table. Designed by Michael H. Nielsen.
Swing Chair. Designed by Henrik Sørig Thomsen. Story Side Table. Designed by Anna Karnov & Clara Mahler.
Orb Lounge Pendants. Designed by 365° North.*





New Veneda Sofa Series. Designed by *Bolia Design Team*.

Veneda is a beautiful and timeless series of sofas and poufs. With a luxurious combination of down and foam filling, it is incredibly soft and inviting, yet designed with a simple expression to exceed fleeting trends and tendencies. Veneda's cover is completely removable, which is another great quality ensuring a long lifetime, being able to adapt the sofa to changing needs and wishes. Its deep seats create an exclusive lounge aesthetic that stands in elegant contrast to the classic design language. A design that refuses to compromise on comfort, elegance or quality. Find possibilities for customisation on page 249.



*New Veneda Corner Sofa in Revi recycled fabric, Light Grey. Designed by Bolia Design Team.
Como Coffee Table. Designed by Glismand & Rüdiger. Orb Floor Lamp. Designed by 365° North.
Funo Rug. Designed by Bolia Design Team.*





Como Coffee Table in Grey-white marble.
Designed by *Glismand & Rüdiger*.
Forma Tableware Series.
Designed by *Ferriani Sbolgi*.
Arcs Tableware Series.
Designed by *Büro Famos*.

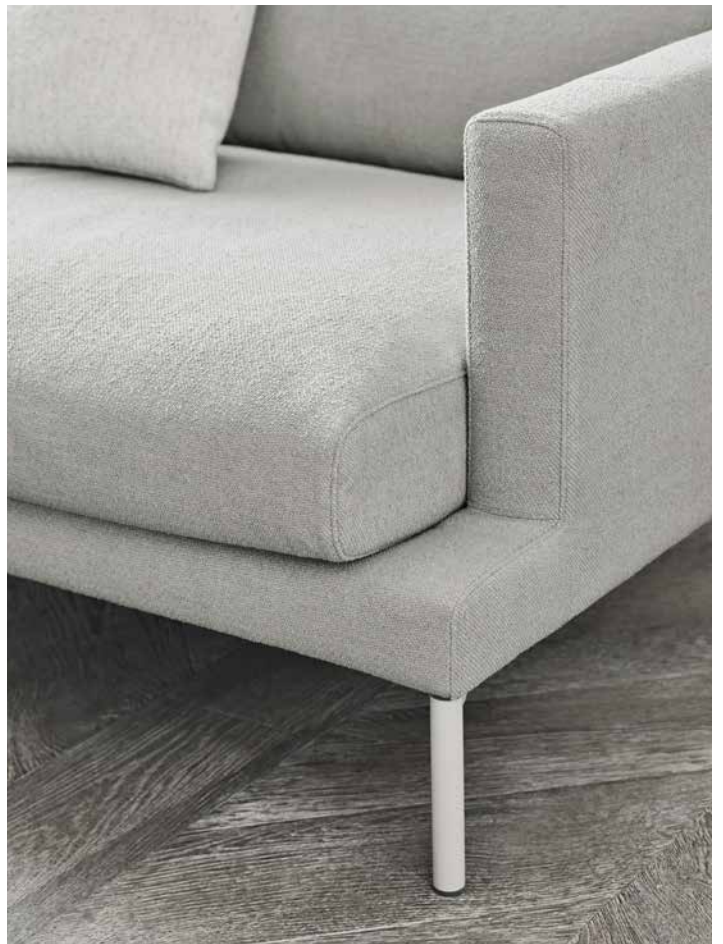

New Veneda Corner Sofa in Revi recycled fabric, Light Grey.
Designed by *Bolia Design Team*.

New Soft Collection Kitchen Cloths. Designed by Bolia Design Team.

New Soft Collection Tea Towels. Designed by Bolia Design Team.

Net Basket. Designed by Büro Famos.

Zeppelin Cutlery. Designed by Yonoh Creative Studio.





New Rheolog Series. Designed by *jüngerkuhn*.
Arcs Tableware Series. Designed by *Büro Famos*.
Soft Collection Napkin. Designed by *Bolia Design Team*.



Angle Modular Sofa. Designed by *Says Who*.

Angle is designed by Says Who, and the asymmetrical, organic shapes give the sofa a multifunctional yet playful design. Angle is handmade in Europe by skilled craftsmen and -women, who ensure the best quality in every tailor-made sofa. Angle's inside is built in FSC® certified wood to reinforce the solid, authentic quality. Finish your Angle modules in the STANDARD 100 by OEKO-TEX® certified fabric of your choice. Find possibilities for customisation on page 261.



Angle Modular Sofa in Revi recycled fabric, Dark Beige. Designed by *Says Who*. Cosh Armchair in Vilme bouclé, Beige. Designed by *Kateryna Sokolova*. Tuk Coffee Table. Designed by *Büro Famos*. Funo Rug. Designed by *Bolia Design Team*. Forma Flowerpot. Designed by *Ferriani Sbolgi*.



Angle Modular Sofa in Revi recycled fabric, Dark Beige.
Designed by *Says Who*.



New Zyl Poufs. Designed by Glismand & Rüdiger.



*Tuk Coffee Table in travertine.
Designed by Büro Famos.*







Noora Modular Sofa. Designed by *Bolia Design Team*.

The elegant design of Noora gives you a modular sofa that combines excellent craftsmanship with aesthetics and comfort. All the wood comes from FSC® certified forestry and the upholstery fabric is certified according to STANDARD 100 by OEKO-TEX®. A sofa with a simple look and fine, handmade details that enhance the luxurious design. A sofa made to last. Find possibilities for customisation on page 246-247.



Noora Modular Sofa in Monza bouclé, Beige. Designed by *Bolia Design Team*.
Noora Pouf in Monza bouclé, Beige. Designed by *Bolia Design Team*.
Cosh Armchair in Vella sheepskin, Beige. Designed by *Kateryna Sokolova*.
New Larch Coffee Table. Designed by *Dazingfeelsgood*.
New Lunaria Pendants. Designed by *Design Studio Niruk*.
Braid Rug. Designed by *Bolia Design Team*.



Noora Modular Sofa in Monza bouclé, Beige.
Designed by *Bolia Design Team*.





*New Latch Coffee Table. Designed by Dazingfeelsgood.
Forma Tableware Series. Designed by Ferriani Sbolgi.
Una Vase. Designed by Kateryna Sokolova.*



*Cosh Armchair in Vella sheepskin, Beige.
Designed by Kateryna Sokolova.*





Graceful Table. Designed by *Michael H. Nielsen*.
New Apelle Chair. Designed by *Busetti Garuti Redaelli*.
New Lunaria Pendant. Designed by *Design Studio Niruk*.
Net Baskets. Designed by *Büro Famos*.



Cana Storage Series

Designed by Steffensen & Würtz



Every design in the Cana series is made in beautiful, FSC® certified oak with a distinctive detail of intricate wicker decorating the fronts. The combination of the naturally tactile materials bring out an iconic, light and calm appearance. Store your belongings in plain sight behind the glass doors or slightly hidden away behind the airy wicker.

The designers have found inspiration in the Danish seaside hotels' tranquil atmosphere, where the peaceful surrounding nature creates a calming feeling.

Cana is designed by the Danish duo, Steffensen & Würtz. With an honest approach to design, they strive to create pieces that push

our boundaries and create value in everyday life. They love challenging their creative and methodological approach in order to create products and furniture that make sense and possess great personality. According to them, design should awaken your curiosity – and most importantly, it should speak to your senses and make you smile.



Trapeze Clothes Rack. Designed by *Steffensen & Würtz*.
New Neutra Shelving System. Designed by *Arnau Reyna*.
New Zyl Pouf. Designed by *Glismand & Rüdiger*.
Haven Mirror. Designed by *Steffensen & Würtz*.
Orb Pendants & Table Lamp. Designed by *365° North*.





Net Basket. Designed by Büro Famos.
New Soft Collection Towel. Designed by Bolia Design Team.
Soft Collection Bed Linen. Designed by Bolia Design Team.





*New Ripple Mirror. Designed by Büro Famos.
Orb Lounge Pendant. Designed by 365° North.
New Zyl Pouf. Designed by Glismand & Rüdiger.*





*New Elope Mirror. Designed by Allan Nøddebo.
New Graceful Bench. Designed by Michael H. Nielsen.
New Hour Vases. Designed by 201 Design Studio.
New Soft Collection Plaid. Designed by Bolia Design Team.*

Haven Bed Series. Designed by *Steffensen & Würtz*.

Haven is a range of bed frames, headboards and mirrors. The minimalist bed frame is made of FSC® certified, solid oak, as well as a soft, inviting headboard that matches the frame. The crafted bed frame is designed with a wide ledge, adding both an uncluttered appearance and extra functionality, with the surface being ideal for placing your morning coffee or a book.

Haven Bed Frame. Designed by *Steffensen & Würtz*.

Haven Headboard. Designed by *Steffensen & Würtz*.

Orb Pendants. Designed by *365° North*.

New Soft Collection Bed Linen. Designed by *Bolia Design Team*.







Haven Bed Series

Designed by Steffensen & Würtz



Haven is a series of bed frames, headboards and mirrors. The minimalist bed frame is made of FSC® certified, solid oak and combines elegantly with the soft, inviting headboard that matches the frame. Dressed in your choice of STANDARD 100 by OEKO-TEX® certified upholstery, for you to design your very own version and create a calm, cohesive and luxurious bedroom.

The bed frame is designed with a wide surrounding frame, adding both an elegant appearance and extra functionality, with the surface being ideal for placing your morning coffee or favourite book. And the series also include a range of handcrafted mirrors, made to catch and subtly reflect the first rays of morning sun, bringing nature into your home's most calming space.

The designers behind, Steffensen & Würtz, created Haven bed frames and headboards from a minimalist perspective, combined with a love of handcrafted details and respect for natural, solid and durable materials. All combined to make Haven a tranquil sanctuary for everyday life and slow weekends.



Haven Mirror Series. Designed by *Steffensen & Würtz*.



New Soft Collection Bed Linen & Bedspread. Designed by Bolia Design Team.
New Soft Collection Cushions. Designed by Bolia Design Team.
New Soft Collection Curtains. Designed by Bolia Design Team.



Pira Sofa Bed Series. Designed by *Joa Herrenknecht*.

Pira is an elegant, almost sculptural series of sofa beds and matching poufs designed by the German designer, Joa Herrenknecht. Created as a functional sofa bed with an aesthetic profile looking and feeling nothing like the ordinary sofa bed. Instead functions are cleverly hid, but still intuitive, like the hidden storage compartment in poufs and chaise longue modules. The entire series is FSC® certified, and the sofa bed has a built-in fold-out mechanism of the highest quality that is skilfully disguised but reveals a soft mattress, allowing you to sink in and unwind most comfortably. A beautiful design with clever details and timeless, clear lines. Find possibilities for customisation on page 263.

Pira Sofa Bed in Ascot bouclé, Light Grey. Designed by *Joa Herrenknecht*. **Pira Pouf.** Designed by *Joa Herrenknecht*. **Plateau Coffee Table.** Designed by *Büro Famos*. **Reflection Floor Lamp.** Designed by *Asger Risborg Jakobsen*. **Tegan Rug.** Designed by *Bolia Design Team*.





Pira Sofa Bed. Designed by *Joa Herrenknecht*.
Plateau Coffee Table. Designed by *Büro Famos*.
Reflection Floor Lamp. Designed by *Asger Risborg Jakobsen*.
Tegan Rug. Designed by *Bolia Design Team*.
Soft Collection Bed Linen. Designed by *Bolia Design Team*.





Cord Storage Series

Designed by Hertel & Klarhoefer



Cord is a series of exquisitely crafted sideboards and highboards, designed by the Berlin-based studio Hertel & Klarhoefer and made by hand in solid oak and beautiful paper cord. The designers find their inspiration mainly in the natural materiality of things, which is evident in the Cord series by the beautiful contrast between the solid oak frame and a delicately airy, woven cord front.

The special paper cord is developed and produced in the small Danish town of Randers by Danish Cord, with local influences of proud tradition reinforcing its origins of good, solid craftsmanship. Storage that gently hides away clutter while adding an eye-catching design element to the space.

Being from Berlin, the vibrant German city is often the designers' source of inspiration.

They like it as it is – metropolitan, creative and direct. And in the intersection of being homebound and travelling around in other countries, their creative ideas are brought to life. Sometimes, the best ideas come in the most unexpected situations. And this is Hertel & Klarhoefer's creative way of working. Exploring the unusual and creating beautiful design that is made to speak to our senses and to last for years, only becoming more beautiful with time.



Aurora Spa Series. Designed by *Bolia Design Team*.

Create a home spa, a luxurious retreat and a quiet sanctuary for your everyday life. Use decorative towels made from soft, natural materials, and storage solutions in the form of woven baskets and wooden boxes, or enjoy our natural fragrances and nourishing lotions, dreamt up of essential oils and fresh fragrance compositions such as Scandinavian sea buckthorn.

Bring in some luxurious notes with minimal effort, creating lush, homely oases that form a soothing backdrop far removed from stress, rush and everyday bustle. Focusing on slowness, clarity and well-being.

X-stool. Designed by *MUT Design*.

New Ribbed Basket. Designed by *Büro Famos*.

New Soft Collection Towel. Designed by *Bolia Design Team*.

Aurora Spa Series. Designed by *Bolia Design Team*.





*New Norie Storage & Display boxes.
Designed by Bolia Design Team.*







Sepia Sofa Series. Designed by *Glismand & Rüdiger*.

Sepia is a series of sofas and poufs designed by the Danish design duo Glismand & Rüdiger with a richly detailed exterior and a soft, inviting profile. The deep seat depth gives the sofa a lounge-like character, which is emphasised by the armrests, seat cushions and back cushions, where the filling is placed and optimised to create the softest possible experience. The seat cushions are also reversible, which makes cleaning easier and prolongs lifetime, and are precisely positioned on a slightly sloped base, which keeps the cushions securely in place. A classic yet modern sofa series, with a harmonious balance of comfort, elegance and quality. Find possibilities for customisation on page 256.



Sepia 6 Seater Sofa with open end in Vilme bouclé, Sand. Designed by *Glismand & Rüdiger*.
New Bowie Armchair in Revi recycled fabric, Ivory. Designed by *Skrivo*. Berlin Coffee Table. Designed by *Hertel & Klarhoefer*.
Reflection Pendant & Table Lamp. Designed by *Asger Risborg Jakobsen*. Braid Rug. Designed by *Bolia Design Team*.



Sepia 6 Seater Sofa with open end
in Vilme bouclé, Sand.
Designed by Glismand & Rüdiger.





Berlin Coffee Table. Designed by Hertel & Klarhoefer.
Reflection Table Lamp. Designed by Asger Risborg Jakobsen.



Reflection Lamp Series

Designed by Asger Risborg Jacobsen



Born with the idea and aspiration to create something simple, elegant and timeless that embraces and highlights the basic features of a lamp, namely the light source and the shade, Reflection came to life.

The designer, Asger Risborg Jacobsen, decided to bring forth and separate the two basic com-

ponents from one another, giving a beautiful reflection and play between the shade and the soft light source. A beautiful design with a both timeless and distinctly modern feel.

The Danish designer and medical student, Asger Risborg Jacobsen, is inspired by the complexity and simplicity of nature. When

designing, he is always breaking his ideas down, leaving room for only the essentials. Like function, beauty, character and craft, and making a powerful but simple impression. For him, aiming towards simplicity means he can create beautiful long-lasting designs. Exactly like Reflection.







New Malin Modular Sofa.

Designed by *Says Who*.

Malin is a beautiful modular sofa with great comfort, created by the Danish design duo Says Who. With removable covers that can be dry cleaned or replaced if needed, the Malin sofa is designed to last for generations. Transform your Malin to fit your preferred expression, by choosing one of the two options of cushions. Whether you prefer a clean and simple look or a luxurious lounge feel, Malin will make a beautiful centrepiece in your living space.

Find possibilities for customisation on page 252.





New Malin Modular Sofa in Ritz velvet, Beige. Designed by Says Who. Cosh Armchair in Vella sheepskin, Beige. Designed by Kateryna Sokolova. Como Coffee Table. Designed by Glismann & Rüdiger. Orb Floor Lamp. Designed by 365° North. Braid Rug. Designed by Bolia Design Team. Forma Series. Designed by Ferriani Sbolgi.



You can transform your Malin to fit your preferred expression, by choosing one of the two options of cushions. Whether you prefer a clean and simple look or a luxurious, cosy lounge feel, Malin will make a beautiful centerpiece in your living space. Whichever style you choose, the covers are fully removable.

New Malin Modular Sofa with removable covers in Ritz velvet, Beige. Designed by Says Who.





New Track Dining Table Series. Designed by Studio Nooi.

The Track dining table is designed by Italian Studio Nooi. Crafted with a combination of luxurious, FSC® certified solid oak and a minimalist metal frame for a light and understated look. The extension leaves are designed to be a beautiful and dramatic addition to the design – the arcs gracefully linking the two planks when in use. A dining table with refined proportions and details, built to last, with exceptional stability and durability.



New Track Dining Table. Designed by Studio Nooi. Kimono Dining Chair. Designed by Pascal Bosetti. Balloon Pendants. Designed by Meike Harde. Case Storage Series. Designed by OOOJA.





Forma Tableware. Designed by *Ferriani Sbolgi*.
New Track Dining Table. Designed by *Studio Nooi*.
New Seed Chair with armrests. Designed by *Hans Thyge & Co*.
Balloon Pendants. Designed by *Meike Harde*.





Case Storage Series. Designed by OOOJA. Hour Vases. Designed by 201 Design Studio.
Forma Flowerpot. Designed by Ferriani Sbolgi.







North Sofa Series. Designed by *Glismand & Rüdiger*.

North is designed by the Danish design duo, Glismand & Rüdiger and is a classic sofa with an elegant profile. The clean lines and solid, FSC® certified wood frame elevate the design, while ensuring a solid internal foundation that gives North a timeless character. The cushions are reversible and the frame made with No-zag springs for optimal and flexible comfort. Simple, durable and timeless. Find possibilities for customisation on page 258.



North 3 Seater Sofa in Soil recycled fabric, Sand. Designed by *Glismand & Rüdiger*. North Pouf in Soil recycled fabric, Sand. Designed by *Glismand & Rüdiger*.
New Visti Armchair in Ascot bouclé, Dark Beige. Designed by *Studio Nooi*. Friedman Shelving System. Designed by *Adam Friedman*.
Berlin Coffee Table. Designed by *Hertel & Klarhoefer*. Vilde Rug. Designed by *Bolia Design Team*.

Friedman Shelving System. Designed by Adam Friedman.
Forma Series. Designed by Ferriani Sbolgi.
Hour Series. Designed by 201 Design Studio.





Arcs Tableware Series. Designed by Büro Famos.



North Sofa in Soil recycled fabric, Sand.
Designed by Glismand & Rüdiger.
Soft Collection Throw.
Designed by Bolia Design Team.

Visti Armchair

Designed by Studio Nooi



Visti is designed by Italian Studio Nooi. An inviting armchair with a distinctive yet familiar style, inspired by the classics of Scandinavian mid-century design but with a decidedly contemporary twist.

Soft and comfortable volumes float within the neat frame crafted in solid, FSC® certified oak that features armrests with a

flat top allows you to rest a drink, book or snack while relaxing and sitting back. The seat is constructed for maximum comfort in durable, moulded furniture foam.

Studio Nooi was founded by Giulia Pesce and Ruggero Bastita in Torino, Italy. Nooi derives from the Italian word “noi”, meaning “us” – the idea being that design is never

an individual act but rather a collaborative process, involving designers, companies, users, artisans and technicians.

Nooi's designs are always the result of good cooperation between people and influenced by society, art, nature and cultural heritage, and the designers are closely involved at every stage of the project development.





Inviting nature inside

We are inspired by the nature that surrounds us and the beautiful, ever-changing seasons. The warm materials, soft colours, the calming atmosphere, and the breath-taking landscapes. We love luscious materials such as solid oak, walnut and ash – natural, oiled, lacquered or stained. Hemp, cork and beautiful paper braid. They all draw a clear reference to our Scandinavian design heritage. And naturally, all the wood we use is FSC® certified, securing sustainable forestry and good working conditions. From the woods and into your home.

There is nothing more soothing than tactile furniture fabrics such as linen, bouclé, wool, velvet or softly woven structures. Whichever fabric is your favourite, you can be certain it is certified according to STANDARD 100 by OEKO-TEX®. Meaning it is completely free of harmful substances.

Our upholstery leathers are all LEATHER STANDARD by OEKO-TEX® certified, which is your guarantee that they are free of harmful substances. And not only are all our leathers of the world's finest quality, they are also completely traceable, securing

transparency every step of the way from local farmer to your living room.

In beautiful contrast to the warm textures, we use natural stones such as travertine, Italian marble, porcelain, ceramics, and polished concrete. And elegant glass – clear, structured, sanded and toned.

Everything perfected by hand and brought to life in our collection and in our stores, embodying the breath-taking, changing seasons and all the things we love.



Highlands Planters. Designed by *Böttcher & Kayser*.
New Forma Flowerpots. Designed by *Ferriani Sbolgi*.
Combo Flowerpots. Designed by *Yonoh Creative Studio*.
New Podium Flowerpots. Designed by *Sanna Völker*.



New Podium Flowerpots. Designed by Sanna Völker.





Grove Flowerpots.
Designed by Anna Karnov & Clara Mahler.





*New Forma Flowerpots. Designed by Ferriani Sbolgi.
Grove Flowerpots. Designed by Anna Karnov & Carla Mahler.
Gap Flowerpots. Designed by Böttcher & Kayser.*



Highlands Planters. Designed by Böttcher & Kayser.



Forma Vases & Flowerpots. Designed by Ferriani Sbolgi.



*New Mingei Vases.
Designed by Denis Guidone Design.*





Orlando Outdoor O2 Modular Sofa. Designed by *Glismand & Rüdiger*.

The Danish design duo, Glismand & Rüdiger, have developed an outdoor version of their sofa classic, Orlando. This has resulted in a sofa with the same beautiful design, made from robust materials that will last for many years. Where the cushions are designed to dry in just a few hours by their ability to allow water to pass through and where the modules' design is accompanied by a matching stone slab that fits in size and can function as a tabletop. Find possibilities for customisation on page 254.

Orlando Outdoor O2 Modular Sofa in Terra outdoor fabric, Sand. Designed by *Glismand & Rüdiger*.

Orlando Outdoor O2 Pouf in Terra outdoor fabric, Sand. Designed by *Glismand & Rüdiger*.





Orlando Outdoor O2 Modular Sofa
in Ocean outdoor fabric, Dark Grey.
Designed by *Glismand & Rüdiger*.





Donut Rechargeable Outdoor Lamp.
Designed by *Michael H. Nielsen*.

New Track Outdoor Table Series. Designed by Studio Nooi.
Create an outdoor dining area with tactile surfaces, refined proportions and exceptional durability. The Track Outdoor dining table is designed by Italian Studio Nooi to interact beautifully with the Nordic landscape with a tabletop in solid concrete resting on a minimalist grey or black metal frame. Materials that are carefully chosen for their durability and weather-resistance. Take good care of your outdoor furniture with our specialised care products.

New Track Outdoor Table. Designed by Studio Nooi.
New Seed Outdoor Chair. Designed by Hans Thyge & Co.

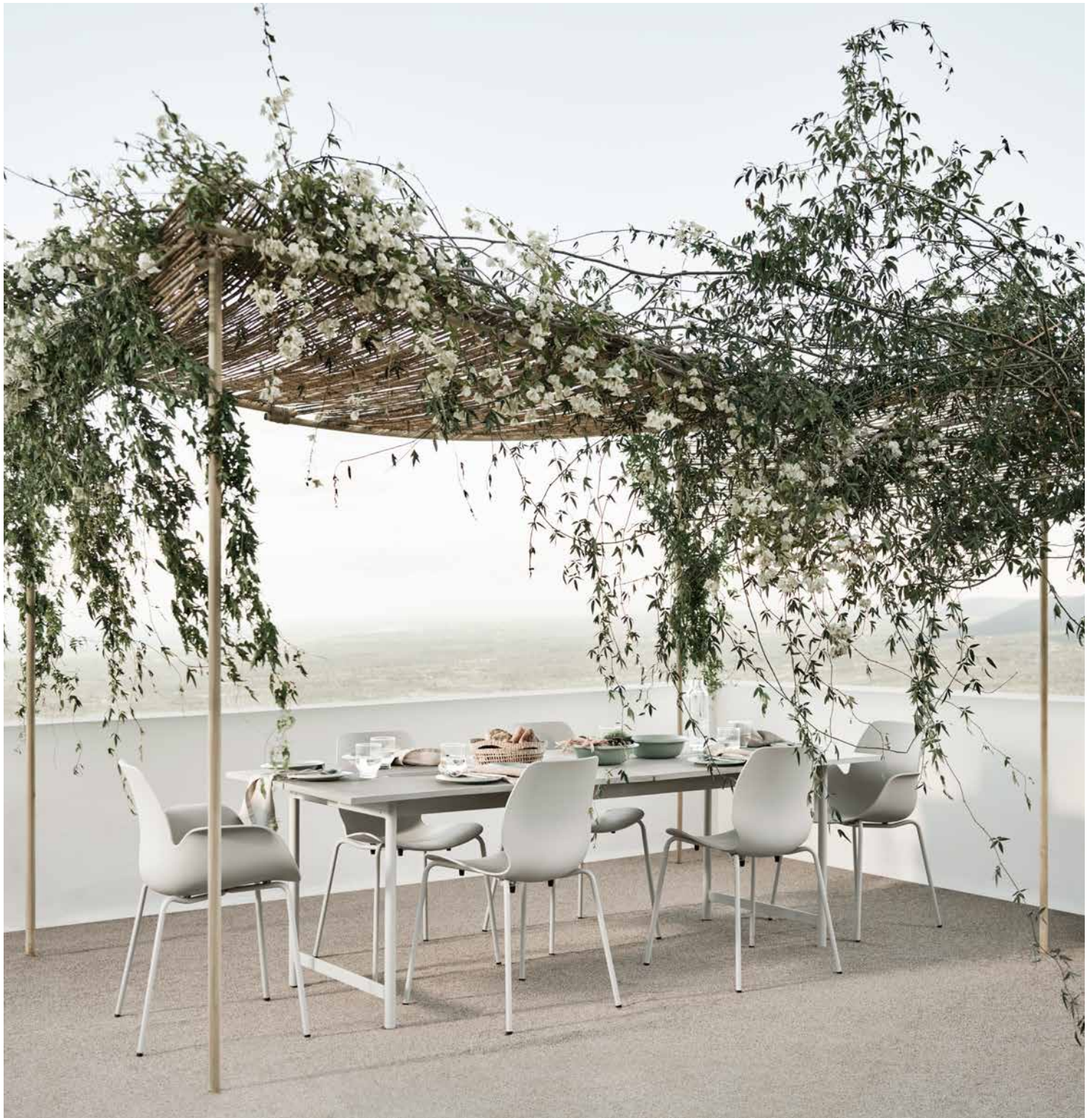



Sling Lounger. Designed by *Ferriani Sbolgi*.
New Drum Coffee Table. Designed by *kaschkasch*.
New Soft Collection Towel. Designed by *Bolia Design Team*.



Calm Pouf in Ocean, Light Grey.
Designed by *Ferriani Sbolgi*.







The Professional Collection

As the world changes and our work life becomes more fluid and exciting, we search for meaningfulness, flexibility and freedom. For new perspectives on how we organize, how we work and how we share.

What was permanent and formal before is becoming open, fun and flexible – gone are the strict and formal confines, the rigid hierarchy, the lukewarm coffee and the dull 9 to 5 office. Welcome to new ways of working.

At Bolia, we love creating beautiful spaces designed to inspire personal growth and creativity. It is about softening the fixed structures – letting brand values flourish and bringing the inspiration and comfort from our homes into every corner of our workspace.

Making room for creativity, individuality and cross border teamwork – breaking down the invisible silos and liberating our colleagues from their static, everyday desks.

Reimagining our work life will bring more meaning and balance into our lives and more sustainable results to our businesses. Make a workspace revolution.

Our new professional collection is designed for new ways of working, for liberating creativity and transforming grey into green.

It is the ideal choice for the professional workspace, the designer restaurant, the luxury hotel, for the workspace at home and everywhere in between.

Our designs are thoroughly tested to meet the world's highest quality demands such as BIFMA and EN Standards – in collaboration with Danish Technological Institute and Bureau Veritas in Germany, the world's leading quality certification agency. And every single design comes with a 10-year warranty. See the terms and conditions on Bolia.com.



Cosima Modular Sofa. Designed by *kaschkasch*.

Cosima is a soft and embracing modular sofa, designed by the Cologne-based design duo, *kaschkasch*. The sofa is characterised by its eye-catching lounge aesthetic and low arm and backrest, which offers the ultimate invitation to relax and unwind. On the inside, Cosima is made of FSC® certified wood and filled with a plush down and feather filling that is sewn into channels to extend durability and secure the iconic shape. Cosima can be designed specifically to fulfil your dreams and needs, in two different seat depths, and you can remove or add modules whenever new needs arise. Find possibilities for customisation on page 244-245.



Cosima Modular Sofa in Linea velvet, Dark Beige. Designed by *kaschkasch*. Como Coffee Table. Designed by *Glismand & Rüdiger*. Link Table. Designed by *Glismand & Rüdiger*. Seed Chair with wheels in Baize fabric, Sand. Designed by *Hans Thyge & Co.* New Neutra Shelving System. Designed by *Arnau Reyna*. Orb Pendants. Designed by *365° North*. Reflection Table Lamp. Designed by *Asger Risborg Jakobsen*. Funo Rug. Designed by *Bolia Design Team*. New Podium Flowerpots. Designed by *Sanna Völker*.

Seed Chair Series

Designed by Hans Thyge & Co



The Seed chair was designed by the Danish design studio Hans Thyge & Co. with a circular future in mind. Designed to embrace you with exceptional comfort and support and tested to meet the highest quality standards.

The moulded seat is made from recycled plastic, which would otherwise have ended its journey as waste. In the process of melting and casting waste plastic bits into one poetic form, a subtle play of colour is created, making every shell unique.

Available in four muted colours and a variety of fabrics and legs and can be upholstered in your choice of STANDARD 100 by OEKO-TEX® certified upholstery fabrics too. The complete collection offers chairs suitable for all settings from the home office and dining room to the professional market and beyond.



Link Table Series. Designed by *Glismand & Rüdiger*.

Link is a series of beautiful tables with a clear-cut and sleek silhouette. The tabletop is made in FSC® certified solid oak and is kept balanced by four slim metal legs that are lowered into the top giving the design a crafted and clean surface. The construction also permits for a longer and slimmer tabletop while never compromising on durability or longevity of the design. Link is designed by the Danish duo, Glismand & Rüdiger, who have thought modularity and flexibility into the design process. Each table therefore works as standalone pieces or placed together in beautiful rows of two or more.

Link Table. Designed by *Glismand & Rüdiger*.

New Seed Chair in Memory bouclé, Light Grey. Designed by *Hans Thyge & Co.*

Orb Pendants. Designed by *365° North*.







Fuuga Nesting Armchair in Memory bouclé, Grey-white.
Designed by *Buseti Garuti Radaelli*.
Berlin Coffee Table. Designed by *Hertel & Klarhoefer*.





Cloud 3 Seater Sofa in Ascot bouclé, Beige. Designed by *Yonoh Creative Studio*
Cloud Armchair in Ascot bouclé, Ivory. Designed by *Yonoh Creative Studio*
Mix Coffee Table. Designed by *Studio Gud*. Balloon Pendants. Designed by *Meike Harde*.

New Turned Table Series. Designed by Bolia Design Team.

Turned tables are made from sustainable, FSC® certified wood and offer a durable starting point supplemented by an aesthetically pleasing exterior. The sleek and understated design language makes the tables suitable for smaller homes, cafés and restaurants without taking up too much space, but with just the right fit. The table base is turned from one solid wood block, which explains the name 'Turned table' and emphasises the discreet yet extraordinary design that is characteristic of the whole series.

New Turned Table. Designed by Bolia Design Team.

Swing Chair. Designed by Henrik Sorig Thomsen.

New Flor Bar Stool. Designed by Martin Lauritsen.

New Acorn Pendants. Designed by 365° North.





Link Table.
Designed by *Glismand & Rüdiger*.
Palm Chair with wheels in Baize fabric, Grey.
Designed by *Says Who*.
Reflection Table Lamp.
Designed by *Asger Risborg Jakobsen*.
Vira Rug.
Designed by *Bolia Design Team*.





*New ROD Storage Series. Designed by kaschkasch.
New Seed Chairs. Designed by Hans Thyge & Co.
New Brida Rug. Designed by Bolia Design Team.*



*New Scribe Table Lamp.
Designed by Studio Finna.*

Graceful Desk. Designed by *Michael H. Nielsen*.
Swing Chair. Designed by *Henrik Sørig Thomsen*.
Reflection Table Lamp. Designed by *Asger Risborg Jakobsen*.
Alve Rug. Designed by *Bolia Design Team*.





New House Storage Series. Designed by Halskov & Dalgaard.



*New Unio Office Storage.
Designed by Böttcher & Kayser.*

Kite Chair

Designed by Studio Nooi



Giulia Pesce and Ruggero Bastita both studied and worked in Denmark prior to founding their studio in Torino, Italy, and built their approach to design with strong roots in both traditions. The designers believe that great design is a collaborative process, and so, even the smallest detail is carefully considered

when they create furniture. Exactly this is true for the Kite chair too.

A magnificently handcrafted design that is stackable, which is difficult to achieve when designing chairs in wood. A chair with an at the same time dynamic and sim-

ple identity – inspired by the natural force of the Nordic winds.

The sides of the curved backrest are made of steam bent, FSC® certified solid oak and function as armrests, ensuring a great seating comfort.





A world of design

What if, just for a brief moment, time stood still? A moment where you could find a calm and mindful place, away from the busy city life. You will find this in our soothing stores. Designed with mindful retail and beautiful experiences in mind – dressed up as inviting homes with designs from our collection.

We invite you to explore, discover, touch and experience – at your own pace – in your own city. We do our best to make

every store a tribute to the local community – every city and every building have their own compelling stories to tell.

Come on in and settle down with a cup of slow-brew coffee from La Cabra. Take delight in the inspiration and the serene atmosphere. Try out the comfort of our sofas, put your feet up and bring your busy day to a peaceful standstill.

We are here to help and share our passion for Scandinavian design, natural materials, curated possibilities and sustainable choices.

Welcome to a world of design.



We are here to help

Every Bolia store is a calming sanctuary where you are free to feel at home. Inspired by the vivid nature that surrounds us, inviting you to slow down and discover timeless, Scandinavian design – all crafted, tailored and perfected by hand.

When exploring the Bolia store, you will find our creative space, *The Design Atelier*,

designed for inspiration, personalisation and fun. It is the inspirational heart of a Bolia store.

You can find your favourite creative expression between our carefully curated mood boards, inspired by the changing Scandinavian seasons. Our fabrics and materials are of the highest quality and handpicked

to make sure everything will blend together effortlessly.

We love to guide you through the myriad of choices – to find the style that is right, just for you. We are here to help and inspire.

Stop by for a slow-brew coffee and let your ideas flourish in our world of design.





Creating inspiring spaces

We love sharing our passion for New Scandinavian Design, creative spaces and mindful choices. That is why we have created eight different moods inspired by nature's changing seasons and based on the materials, colours, designs and natural expressions we love so much. You can explore the moods right here or visit us in your nearest store where, together with our consultants, you can let your creativity bloom and ideas flow.



Natural tranquility

A fresh, minimalistic expression with crisp green, beige and light grey colours, radiating an understated luxury alongside rich bouclé, marble and white oiled oak. Inspired by the misty sky, the wind and the blooming greenery, textiles are soft, tactile and inviting, such as linen and slightly see-through fabrics, creating an invigorating and dreamlike feeling.



Calming light

A warm, light atmosphere with reference to the calming colours of the seaside with gentle blue and sand tones. The look is airy, playful and bright, supported by soothing and tactile fabrics such as linen, bouclé and wool in beautiful and calming beige-toned colours. Solid, oiled wood and other natural materials such as hemp, cork and paper braid define a clear reference to the Scandinavian nature and craftsmanship.



Seeking silence

An elegant simplicity characterized by light earthy beige tones, transparency and a beautiful, natural quality. The materials exude lightness and feature soft nuances and contrasts and materials that add simplicity and tactility. Based on natural materials like white oiled wood, Italian white marble, natural wool and luxurious bouclé fabrics, serenity shines through.



Liberated creativity

A dynamic and creative universe, where subtle rose and light greige tones form the backdrop for bold material combinations and compositions. A decadent and bright expression inspired by the natural colour palette of the beach, the sand and the sun. Rich and tactile surfaces like luxurious velvet and natural leather combined with elegant materials such as polished steel and solid wood.



Continental elegance

An elegant mood inspired by a warm and comforting brown and earth-toned colour palette paired with details from meticulously crafted oak and walnut wood – reflecting the changing seasons. Combining lightness and elegance with a deeper, more seductive feel. Contrasts are explored, and materials such as natural leather, luxurious brass and soft textiles meet in nature's warm tones.



Dimmed decadence

A luxurious mood with a warm and balanced spectrum of clay, burnt brown and dark green mixed with crafted details in solid wood and soft, natural surfaces like traceable leathers and tactile bouclé fabrics. Wood, wind, dark green and burnt brown notes create beautiful contrasts to natural stones like Italian marble and travertine or polished concrete.



Quiet breeze

A universe rooted in an elegant expression of sophisticated grey and ice-blue tones with natural references to winter, cosiness and coffee. Clean surfaces, interpreted in hand-finished steel, beautiful porcelain, luxurious wood and Italian marble, provide tranquility and peace of mind. Uniquely handmade ceramics and glassware find their way into these calming spaces.



Warm sanctuary

A stylish universe of grey, dark brown and fresh white notes expressed with references to the Scandinavian winter with a touch of continental luxury. The mood invites both reflection and mindfulness together with friendship and intimacy. Materials are inviting and tactile – handwoven wool fabrics and soft lambskin, combined with eye-catching contrasts of clear crystal glass and handmade ceramics.



Tactility and quality

Every furniture design in our collection is customised to meet your needs. From shape and size to expression and tactility everything is tailor-made specifically for you and to fit the space it is meant for perfectly.

There is nothing more soothing than tactile fabrics. And our selection of upholstery fabrics and leathers is curated and refined to create beautiful and cohesive spaces with a calm, timeless colour scheme – whether you are looking for bouclé, linen, velvet, recycled fabrics, wool or leathers.

To add the final decorative touch to your tailor-made sofa, our Classic cushions are designed with customisation in mind too, being available in every fabric or leather option as well. And every fabric can be bought by the metre, to complete your interior with made-to-measure cushions, curtains, bed covers and more.

Whatever you choose, you can be sure that every single fabric is STANDARD 100 by OEKO-TEX® certified and a selection of fabrics carry the EU Ecolabel as well. And our upholstery leathers are, apart from being

of the finest quality in the world, LEATHER STANDARD by OEKO-TEX® certified and 100% traceable – ensuring transparency and improved animal welfare. An incredible natural material that becomes only more beautiful with time.

Explore our tactile universe of carefully curated fabrics and leathers in *The Design Atelier* – in your local store or at [Bolia.com](https://www.bolia.com).



Bouclé

Our Bouclé fabrics have a characteristic textured expression and inviting softness. Elegantly woven using a technique where small nooses are combined to create the distinctive contour and feel. Choose between our beautiful Monza, Vilme & Memory bouclé fabrics.



Linen

Inspired by the sky, wind and blossoming greenery, linen fabrics offer a soft and inviting quality. A soft texture and soothing colours draw calming references to nature creating a calm, minimalistic atmosphere. Linen has strong, durable fibres ensuring your sofa will last.



Recycled fabrics

We offer a selection of beautiful, recycled fabrics. Sira is 100% recycled, woven cotton for a soft and natural feel. Our Revi fabric is made of 100% recycled plastic waste, breathing new life into waste material. Our elegant Bergo fabric carries the EU Ecolabel and is made solely of recycled plastic bottles.



Velvet and corduroy

Our velvet fabrics are resilient and easily cared for with an incredible abrasion resistance and durability. Choose between Globa, Linea or Ritz. Globa is characterized by its modern retro look, where Linea has a subtle and feminine texture, and finally, Ritz is one of the world's best quality velvet fabrics, and offers a truly luxurious and bold impression.



Wool

Our wool fabrics are made from 100% New Zealand wool and are characterised by a warm and natural feel. Laine has a mélange effect that creates a vibrant appearance and carries the EU Ecolabel. Qual's structure emphasises great quality giving a distinctive, rustic feel. All beautifully comforting fabrics.



Leather

Our fine European and Australian upholstery leathers are LEATHER STANDARD by OEKO-TEX® certified and 100% traceable, securing transparency and improved animal welfare from the hand of the producer and into your home. Austin is a luxurious nubuck leather with a velvet-like touch, Sydney is a classic aniline leather with a natural feel and Quattro's treated surface is resilient and effortless.

Welcome to our stores

Austria

Graz — Murgasse 1
Vienna — Schottenring 19

Belgium

Antwerp — Kammenstraat 33
Bruges — Zuidzandstraat 27
Brussels — Avenue Louise 165
Ghent — Kortedagsteeg 12

Denmark

Aalborg — Danmarksgade 27
Aarhus — Værkmestergade 11
Copenhagen — Chr. IX gade 7
Copenhagen — Falkoner Allé 31
Copenhagen — Field's, Arne Jacobsens Allé 12
(Relocating Autumn 2022)
Copenhagen — Kuglegårdsvej 6,
(Opening Autumn 2022)
Copenhagen — Trianglen, Østerbrogade 78
Copenhagen — Vesterbrogade 67
Lyngby — Lyngby Hovedgade 59-61
Odense — Rosengårdcentret
(Relocating Autumn 2022)
Odense — Fisketorvet 5
(Opening Autumn 2022)
Roskilde — RO's Torv 1, St., Butik 215

France

Cannes — 9 Rue du Maréchal Foch
Lille — 32 Rue Faidherbe
Lyon — 5 Rue Grolée
Marseille — 39 Rue Grignan
Nice — 31 Avenue Notre Dame
Paris — Boulevard St. Germain 90
Paris — 98 Boulevard de Sébastopol
Reims — 25 Rue des Élus

Germany

Berlin — Charlottenburg, Fasanenstraße 31a
Berlin — Mitte, Chausseestraße 1
Berlin — Münzstrasse 14-16
Bremen — Ansgaritorstraße 21
Düsseldorf — Breite-Straße 7
Essen — Kettwiger Straße 2-10
Frankfurt am Main — Börsenstraße 13-15
Hamburg — Dammtorstraße 30
Hamburg — Hoheluft, Straßenbahnring 19
Hannover — Schillerstraße 31
Köln — Brückenstraße 2
Lübeck — Breite Straße 29,
(Opening Autumn 2022)
München — Alte Börse, Lenbachplatz 2a
München — Schwabing, Hohenzollernstraße 42
Nürnberg — Königstraße 4
Potsdam — Brandenburger Str 48
Stuttgart — Marienstraße 1

Luxembourg

Luxembourg — 33 Grand-Rue

Netherlands

Alkmaar — Mient 21-23
 Amsterdam — Raadhuisstraat 55
 Amsterdam — Utrechtsestraat 78-80
 Breda — Veemarktstraat 23
 Den Bosch — Kerkstraat 34
 Den Haag — Noordeinde 85
 Eindhoven — Nieuwe Emmasingel 36
 Haarlem — Barteljorisstraat 12
 Rotterdam — Oude Binnenweg 132
 Utrecht — Oudkerhof 25

Norway

Bergen — Vaskerelven 39
 Bodø — City Nord, Stormyrveien 20
 Haugesund — Oasen Storsenter,
 Austbøvegen 16
 Kristiansand — Sørlandssenteret,
 Barstølveien 33
 Lillestrøm — Solheimsgata 2D
 Oslo — Grünerløkka, Thorvald Meyers
 gate 72 A
 Oslo — Henrik Ibsens Gate 18
 Oslo — Sandvika Storsenter, Sandviksveien 176
 Oslo — Skøyen, Verkstedveien 1
 Oslo — Storo Storsenter,
 Vitaminveien 7-9, Etasje 3
 Ski — Ski Storsenter, Jernbanesvingen 6,
 Etasje 3
 Stavanger — Kvadrat Kjøpesenter,
 Gamle Stokkavei 1
 Stavanger — Torgterrassen, Kirkegaten 2
 (Relocating Spring 2023)
 Stavanger — Verksgata 1
 (Opening Spring 2023)
 Tromsø — Skippergata 32
 Trondheim — Beddingen, Nedre Elvehavn
 Beddingen 3
 Tønsberg — Storgaten 37
 Ålesund — Amfi Moa, Langlandsveien 25

Singapore

Singapore — 215 Henderson Road #01
 (Opening Autumn 2022)

Sweden

Göteborg — Arkaden, Fredsgatan 1
 Malmö — Stortorget 31
 Stockholm — Kungsholmen, Fleminggatan 40
 Stockholm — Södermalm, Götgatan 55

Spain

Barcelona — Avinguda Diagonal 478
 (Opening Autumn 2022)

Switzerland

Basel — Eisengasse 11
 Genève — Pictet de Rochemont 7
 Lausanne — Rue Haldimand 8
 Luzern — Kapellgasse 11/15
 St. Gallen — Neugasse 33
 Zürich — Uraniastrasse 12

We are here to help

Bolia Customer Care
 customerservice@bolia.com
 +45 88 96 02 26
 Find opening hours at Bolia.com

Bolia Head Office
 Bolia International A/S
 Værkmestergade 11, 1
 8000 Aarhus C, Denmark
 +45 88 96 02 25

Bolia Wholesale
 wholesale@bolia.com

Bolia PR
 pr@bolia.com



Things you might not know about us...

Our collection, presented in this Lookbook, is created by 68 designers from 19 countries, who all share a passion for New Scandinavian Design.

All our furniture designs come in a wide range of materials, upholstery fabrics and colours – customised and tailormade just for you.

The slow-brew coffee we serve in our stores is developed exclusively for Bolia by the world-renowned coffee roasters from La Cabra Coffee.

Twice a year we launch a new curated collection – and every new design is 18 months in the making, from the first sketches to the final product.

Every design in our collection is handmade by skilled craftsmen and -women, and more than 90% of our collection is produced within the EU.

All our elegant fabrics are carefully curated, certified according to STANDARD 100 by OEKO-TEX® and completely free of harmful chemicals.

We only use FSC® certified wood in the production of our designs and all paper packaging, which ensures sustainable forestry.



Our upholstery leathers are all LEATHER STANDARD by OEKO-TEX® certified, free of harmful substances and completely traceable, securing transparency and improved animal welfare.

All our rugs are handwoven using traditional methods and Care & Fair labelled, supporting good working- and living conditions for the weavers and their families.

All the beautiful marble and travertine used in our designs are of the finest quality from Italy.

We are delighted to give a 10-year warranty on every single design in our collection. Read about the terms and conditions on Bolia.com.

A selection of our upholstery fabrics is certified with the official EU Ecolabel, meaning that they have a lower environmental impact. Gaja C2C, Step Melange, Bergo and Laine are EU Ecolabel certified.



At our annual Bolia Design Awards, we honour and celebrate the bright new talents in our industry and include selected designs into our collection with royalty of sales to the designer.

You can stream our favourite music and exclusive mixtapes on Spotify and SoundCloud – some of the mixes are even produced by our very own CEO.

The Bolia AR app uses 3D-technology that lets you experience many of our sofas in your own home – in their exact size, colour and shape. You can download it for free in the App Store.



We collaborate with our innovative friends at MÅLBAR who help us measure the CO₂-e emissions of our products throughout their lifecycle – as an example our Swing chair has the CO₂-e emission equal to that of 19 average cheeseburgers and the *Lookbook in your hands equal to that of 1,26. You can find the data behind these results and learn about MÅLBAR, CO₂-e and much more on Bolia.com.

At Bolia we are inspired by music and that is why we invite talented DJ's and established artists to perform vibrant Bolia Sofa Sessions, produce mixtapes for our stores and perform live at our store openings across Europe.

We open 1-2 new Bolia stores every month all year around, but no two stores are alike – each store is designed with respect to the existing architecture, the history of the building and the local community.

Our International HQ is located in the heart of the charming city of Aarhus in Denmark – you are always welcome to stop by for a cup of slow brew coffee if you are in the neighbourhood.

We love working with sustainability thinkers like BuildBackBetter, FSC® Denmark and Upcycling Forum to learn and improve our ways.

We have an exciting partnership with Steelcase, the world's largest office furniture manufacturer, with a shared mission to turn grey offices into green ones and making a workspace revolution around the world.

At Bolia Design Awards we give out three great awards with cash prizes: The Jury Prize, the People's Choice Prize, and the Circularity Prize – honouring designs created with sustainability at heart.

We are proud to be part of amfori BSCI and follow the BSCI code of conduct, ensuring the social rights and safety of all our wonderful colleagues and partners around the world.

All our stores contribute to the development of renewable energy by investing in green Certificates of Origin equal to our power consumption.

On an average week, we serve more than 10.000 cups of our slow brewed specialty coffee, exclusively developed for us by our friends from La Cabra Coffee.

We have close to 80 delightful stores spread across Europe and web shop deliveries to all European countries. On top of this, we collaborate with 600 trusted dealers located in more than 50 beautiful countries around the world.

If you would like a sneak peek into the future, we invite you to enjoy our thrilling podcast series "The 20 next years" featuring fascinating international thinkers and thought-provoking topics about what next twenty years might bring. Find it at Bolia.com, Spotify, or iTunes.



This book is certified





Sofa Design Gallery

Scandinavia Sofa Series

Designed by *Glismand & Rüdiger*



NUMBER	PRODUCT NAME	PRODUCT NUMBER	DEPTH x WIDTH x HEIGHT	SEAT DEPTH x HEIGHT
A	Scandinavia Sofa 2 seater	01-402-01	92 x 176 x 80 cm	58 x 47 cm
B	Scandinavia Sofa 2½ seater	01-402-02	92 x 206 x 80 cm	58 x 47 cm
C	Scandinavia Sofa 3 seater	01-402-03	92 x 236 x 80 cm	58 x 47 cm
D	Scandinavia Sofa 3 seater with chaise longue - left	01-402-04	157 x 263 x 80 cm	58 x 47 cm
E	Scandinavia Sofa 3½ seater with chaise longue - left	01-402-06	157 x 293 x 80 cm	58 x 47 cm
F	Scandinavia Sofa 4 seater with chaise longue - left	01-402-08	157 x 321 x 80 cm	58 x 47 cm
G	Scandinavia Corner Sofa 4 seater with open end - left	01-402-10	237 x 251 x 80 cm	58 x 47 cm
H	Scandinavia Corner Sofa 5 seater with open end - left	01-402-12	237 x 281 x 80 cm	58 x 47 cm
I	Scandinavia Corner Sofa 5 seater (2 corner 2)	01-402-14	248 x 248 x 80 cm	58 x 47 cm
J	Scandinavia Corner sofa 5 seater with chaise longue - right - open end - left	01-402-18	237 x 337 x 80 cm	58 x 47 cm
K	Scandinavia Corner Sofa 6 seater with open end - left	01-402-19	237 x 311 x 80 cm	58 x 47 cm
L	Scandinavia Corner Sofa 6 seater with chaise longue - left - open end - right	01-402-23	237 x 367 x 80 cm	58 x 47 cm
M	Scandinavia Corner Sofa 6 seater (2½ corner 2½)	01-402-25	278 x 278 x 80 cm	58 x 47 cm
N	Scandinavia Sofa Bed 2½ seater	01-402-28	100 x 200 x 81 cm	65 x 49 cm
O	Scandinavia Sofa Bed 3 seater	01-402-32	100 x 220 x 81 cm	65 x 49 cm
P	Scandinavia Pouf with storage	02-402-03	70 x 85 x 47 cm	47 cm
Q	Scandinavia Pouf with storage	02-402-04	70 x 100 x 47 cm	47 cm
R	Scandinavia Pouf with storage	02-402-06	70 x 70 x 47 cm	47 cm
S	Scandinavia Sofa Bed 2½ seater with chaise longue - left / right	01-402-30 01-402-31	157 x 286 x 81 cm	65 x 49 cm

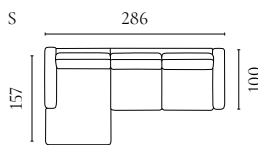
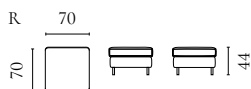
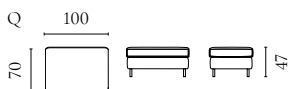
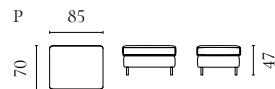
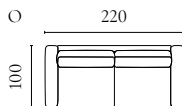
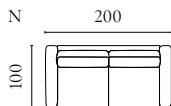
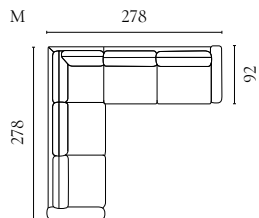
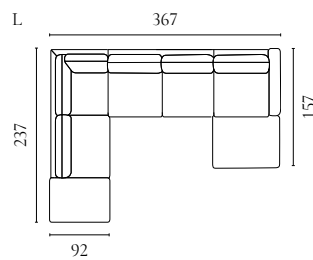
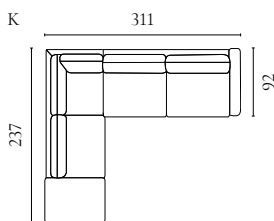
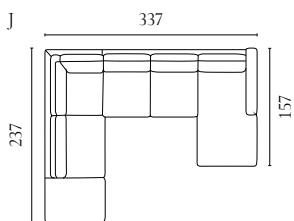
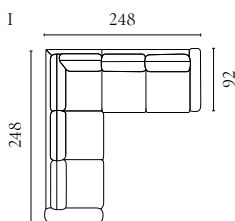
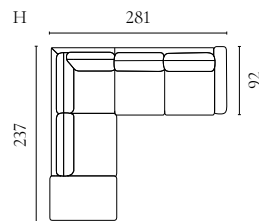
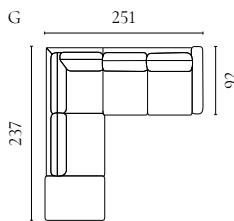
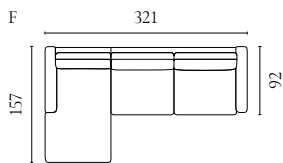
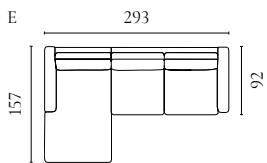
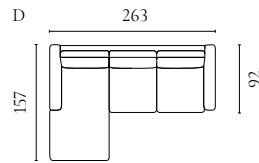
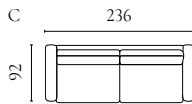
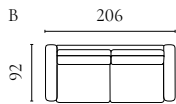
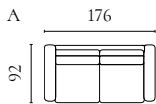

Scandinavia Remix Sofa Series

Designed by *Glismand & Rüdiger*



NUMBER	PRODUCT NAME	PRODUCT NUMBER	DEPTH x WIDTH x HEIGHT	SEAT DEPTH x HEIGHT
A	Scandinavia Remix 2 seater sofa	01-202-01	90 x 162 x 80 cm	58 x 42/45 cm
B	Scandinavia Remix 2½ seater sofa	01-202-05	90 x 192 x 80 cm	58 x 42/45 cm
C	Scandinavia Remix 3 seater sofa	01-202-10	90 x 216 x 80 cm	58 x 42/45 cm
D	Scandinavia Remix 3 seater sofa with 3 cushions	01-202-11	90 x 216 x 80 cm	58 x 42/45 cm
E	Scandinavia Remix Sofa 3 seater with chaise longue - left / right	01-202-15 01-202-20	152 x 246 x 80 cm	58 x 42/45 cm
F	Scandinavia Remix Corner Sofa 4 seater with open end - left / right	01-202-45 01-202-46	282 x 242 x 80 cm	58 x 42/45 cm
G	Scandinavia Remix Corner Sofa 5 seater (2½ corner 2)	01-202-65	242 x 272 x 80 cm	58 x 42/45 cm
H	Scandinavia Remix Corner Sofa 6 seater (2½ corner 2½)	01-202-67	272 x 272 x 80 cm	58 x 42/45 cm
I	Scandinavia Remix Corner Sofa 5 seater with chaise longue right - open end - left Scandinavia Remix Corner Sofa 5 seater with chaise longue left - open end - right	01-202-80 01-202-85	282 x 327 x 80 cm	58 x 42/45 cm
J	Scandinavia Armchair	02-202-30	78 x 85 x 76 cm	51 x 42/45 cm
K	Scandinavia Remix Pouf	02-202-35	48 x 63 x 39 cm	42/45 cm
L	Scandinavia Remix Pouf 75 with storage	02-202-01 02-202-15	70 x 75 x 42 cm	42/45 cm
M	Scandinavia Remix Pouf 90 with storage	02-202-05 02-202-20	70 x 90 x 42 cm	42/45 cm
N	Scandinavia Remix Pouf 100 with storage	02-202-10 02-202-25	70 x 100 x 42 cm	42/45 cm
O	Scandinavia Remix Daybed	01-202-94	85 x 190 x 39 cm	39 cm

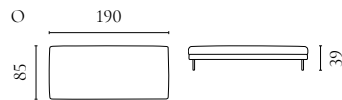
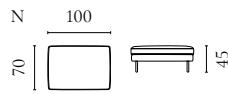
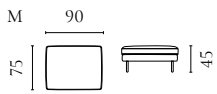
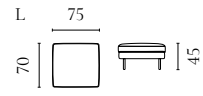
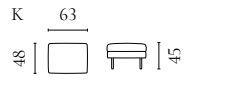
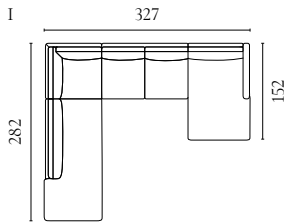
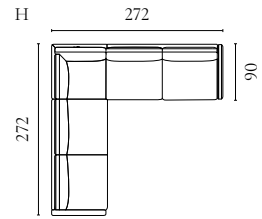
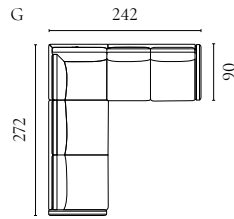
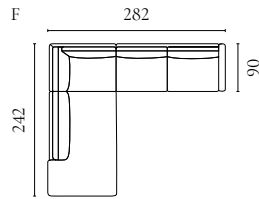
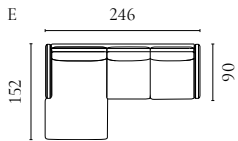
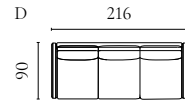
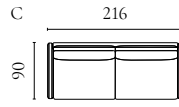
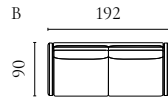
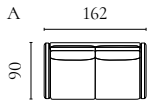

Cosima Modular Sofa

Designed by *kaschkasch*



NUMBER	PRODUCT NAME	PRODUCT NUMBER	DEPTH x WIDTH x HEIGHT	SEAT DEPTH x HEIGHT
A	Cosima Back Unit 100 - small	01-050-01	102 x 90 x 65 cm	72 x 40 cm
B	Cosima Back Unit 100 - large	01-050-05	102 x 120 x 65 cm	72 x 40 cm
C	Cosima Chaise Longue 100 - left / right	01-050-11 01-050-12	150 x 120 x 65 cm	120 x 40 cm
D	Cosima Chaise Longue 100 - large - left / right	01-050-13 01-050-14	150 x 150 x 65 cm	120 x 40 cm
E	Cosima Corner Unit 100 - small - left / right	01-050-16 01-050-17	102 x 120 x 65 cm	72 x 40 cm
F	Cosima Corner Unit 100 - large - left / right	01-050-21 01-050-22	102 x 150 x 65 cm	72 x 40 cm
G	Cosima Corner Unit 100 - left / right	01-050-25 01-050-26	102 x 102 x 65 cm	72 x 40 cm
H	Cosima Back Unit - small	01-060-01	120 x 90 x 65 cm	90 x 40 cm
I	Cosima Back Unit - large	01-060-05	120 x 120 x 65 cm	90 x 40 cm
J	Cosima Chaise Longue - left / right	01-060-11 01-060-12	150 x 120 x 65 cm	120 x 40 cm
K	Cosima Chaise Longue - large - left / right	01-060-13 01-060-14	150 x 150 x 65 cm	120 x 40 cm
L	Cosima Corner Unit - small - left / right	01-060-16 01-060-17	120 x 120 x 65 cm	90 x 40 cm
M	Cosima Corner Unit - large - left / right	01-060-21 01-060-22	120 x 150 x 65 cm	90 x 40 cm
N	Cosima Unit with open end - left / right	01-060-23 01-060-24	120 x 150 x 65 cm	90 x 40 cm
O	Cosima Pouf 100 - small	02-050-01	72 x 90 x 40 cm	40 cm
P	Cosima Pouf 100 - large	02-050-05	72 x 120 x 40 cm	40 cm
Q	Cosima Pouf	02-098-01	90 x 90 x 40 cm	40 cm
R	Cosima Pouf	02-098-05	90 x 120 x 40 cm	40 cm
S	Cosima 2 Units 100 with big corner	00-050-02	102 x 300 x 65 cm	72 x 40 cm
T	Cosima 3 Units 100 with chaise longue - right / left	00-050-03 00-050-04	150 x 300 x 65 cm	72 x 40 cm
U	Cosima 3 Units 100 - large	00-050-06	102 x 330 x 65 cm	72 x 40 cm
V	Cosima 2 Units 100 with chaise longue - large - left - open end - right / left	00-050-07 00-050-08	150 x 300 x 65 cm	72 x 40 cm
X	Cosima 2 Units 100 with chaise longue - large - left - corner unit - large - right / left	00-050-09 00-050-10	102 x 270 x 65 cm	72 x 40 cm
Y	Cosima 2 Units 100 with corner unit - large - left - open end - right / left	00-050-11 00-050-12	102 x 300 x 65 cm	72 x 40 cm
Z	Cosima 2 Units with corner - small	00-060-01	120 x 270 x 65 cm	90 x 40 cm
AA	Cosima 2 Units with corner - large	00-060-02	120 x 240 x 65 cm	90 x 40 cm
AB	Cosima 2 Units with chaise longue - large - left - corner unit - large - right / left	00-060-09 00-060-10	150 x 300 x 65 cm	90 x 40 cm
AC	Cosima 2 Units - with corner unit - large - left - open end - right / left	00-060-11 00-060-12	120 x 300 x 65 cm	90 x 40 cm

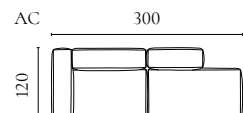
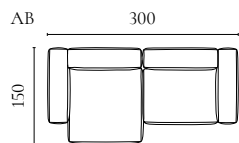
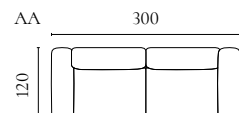
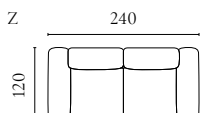
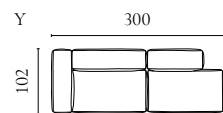
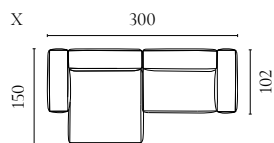
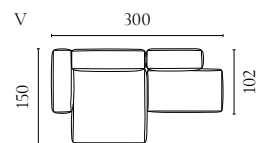
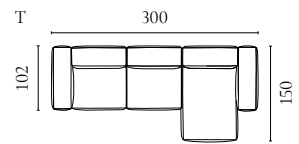
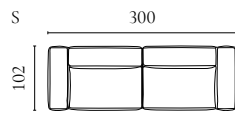
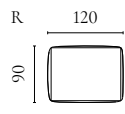
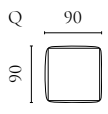
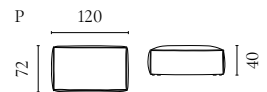
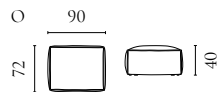
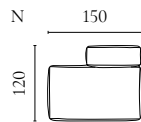
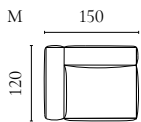
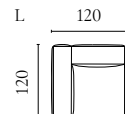
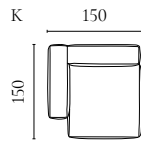
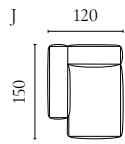
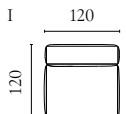
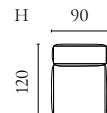
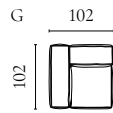
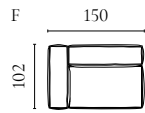
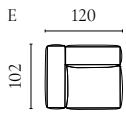
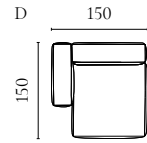
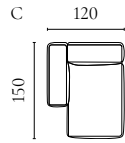
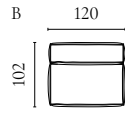
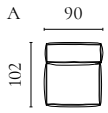

Noora Modular Sofa

Designed by *Bolia Design Team*



NUMBER	PRODUCT NAME	PRODUCT NUMBER	DEPTH x WIDTH x HEIGHT	SEAT DEPTH x HEIGHT
A	Noora Corner Unit with armrest - left / right	01-065-01 01-065-05	107 x 115 x 80 cm	64 x 43 cm
B	Noora Corner Unit with armrest - left / right	01-065-10 01-065-15	107 x 125 x 80 cm	64 x 43 cm
C	Noora Corner Unit with armrest - left / right	01-065-20 01-065-25	127 x 125 x 80 cm	84 x 43 cm
D	Noora Corner Unit with armrest - left / right	01-065-30 01-065-35	127 x 145 x 80 cm	84 x 43 cm
E	Noora Back Unit	01-065-40	107 x 90 x 80 cm	64 x 43 cm
F	Noora Back Unit 100	01-065-45	107 x 100 x 80 cm	64 x 43 cm
G	Noora Back Unit	01-065-50	127 x 100 x 80 cm	84 x 43 cm
H	Noora Combi Corner	01-065-55	100 x 100 x 80 cm	64 x 43 cm
I	Noora Combi Corner	01-065-60	120 x 120 x 80 cm	84 x 43 cm
J	Noora Combi Corner	01-065-65	100 x 120 x 80 cm	64 x 43 cm
K	Noora Combi Corner	01-065-70	120 x 100 x 80 cm	84 x 43 cm
L	Noora Unit - open end rounded left - small	01-065-80	146 x 195 x 80 cm	64 x 43 cm
M	Noora Unit - open end rounded left - large	01-065-82	166 x 205 x 80 cm	84 x 43 cm
N	Noora Chaise Longue - left - small	01-065-90	190 x 125 x 80 cm	147 x 43 cm
O	Noora Chaise Longue - left - large	01-065-92	190 x 125 x 80 cm	147 x 43 cm
P	Noora Pouf	02-115-01	107 x 50 x 43 cm	43 cm
Q	Noora Pouf	02-115-05	127 x 50 x 43 cm	43 cm
R	Noora Pouf	02-115-10	100 x 100 x 43 cm	43 cm
S	Noora Pouf	02-115-15	120 x 120 x 43 cm	43 cm
T	Noora 2 Units	00-065-01	107 x 250 x 80 cm	64 x 43 cm
U	Noora 3 Units	00-065-10	127 x 350 x 80 cm	84 x 43 cm
V	Noora 3 Units	00-065-20	265 x 265 x 80 cm	84 x 43 cm
X	Noora 5 Units	00-065-25	305 x 305 x 80 cm	64 x 43 cm
Y	Noora 3 Units with open end rounded - small - right / left	00-065-35 00-065-40	107 x 400 x 80 cm	43 cm
Z	Noora 3 Units with open end rounded - large - right / left	00-065-45 00-065-50	127 x 430 x 80 cm	43 cm
AA	Noora 3 Units with chaise longue - small - right / left	00-065-55 00-065-60	107 x 330 x 80 cm	43 cm
AB	Noora 3 Units with chaise longue - large - right / left	00-065-65 00-065-70	127 x 350 x 80 cm	43 cm
AC	Noora 3 Units with chaise longue - small - left - open end rounded - small - right	00-065-80	107 x 410 x 80 cm	43 cm
AD	Noora 3 Units with chaise longue - large - right - open end rounded - large - left	00-065-90	127 x 430 x 80 cm	43 cm

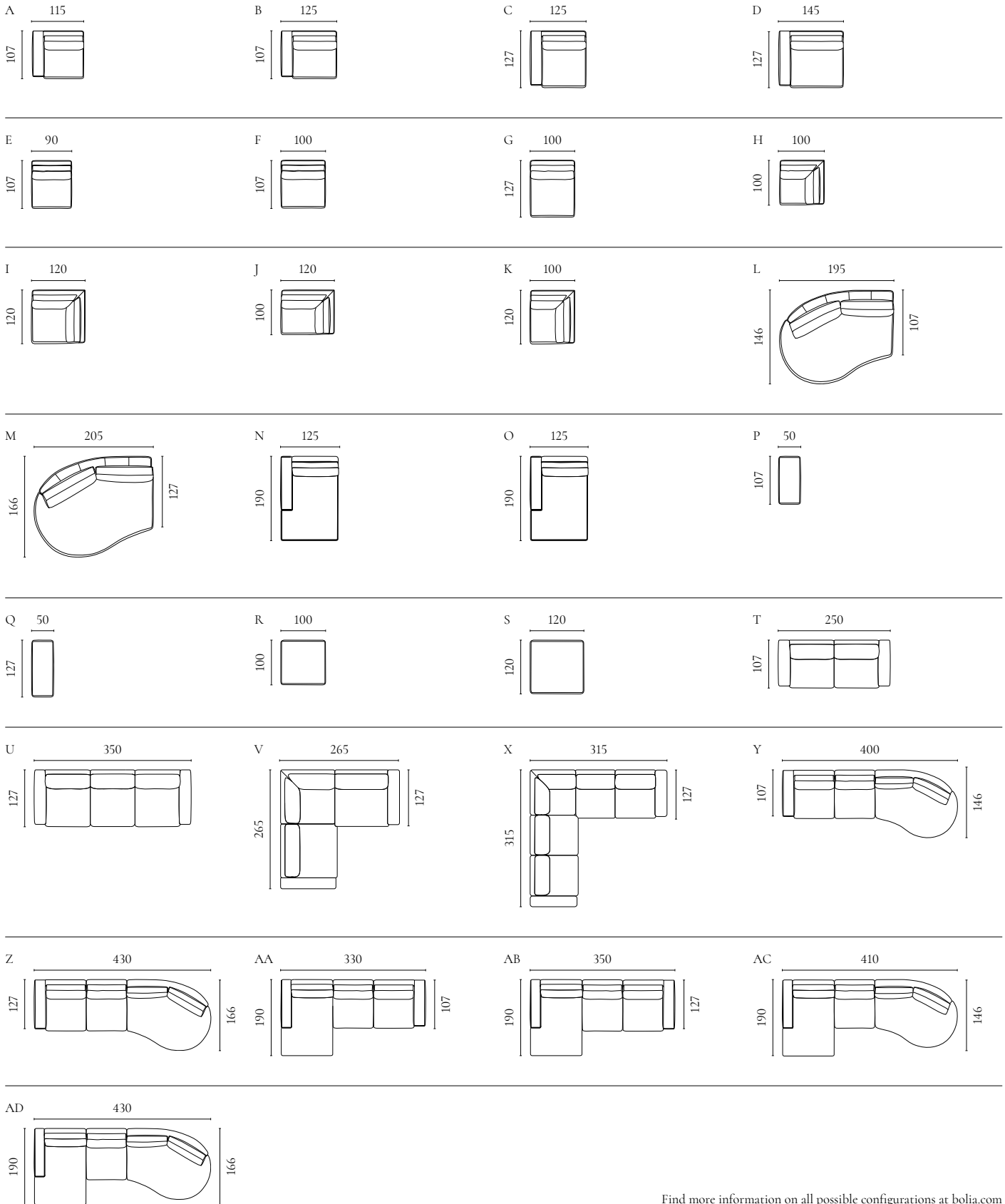

Elton Sofa Series

Designed by *Glismand & Rüdiger*



NUMBER	PRODUCT NAME	PRODUCT NUMBER	DEPTH x WIDTH x HEIGHT	SEAT DEPTH x HEIGHT
A	Elton Sofa 2 seater	01-030-01	100 x 186 x 77 cm	60 x 42 cm
B	Elton Sofa 2½ seater	01-030-05	100 x 220 x 77 cm	60 x 42 cm
C	Elton Sofa 3 seater	01-030-10	100 x 258 x 77 cm	60 x 42 cm
D	Elton Sofa 3 seater with chaise longue - left / right	01-030-20 01-030-25	163 x 266 x 77 cm	60 x 42 cm
E	Elton Sofa 3½ seater with chaise longue - left / right	01-030-30 01-030-35	163 x 300 x 77 cm	60 x 42 cm
F	Elton Sofa 4 seater with chaise longue - left / right	01-030-40 01-030-45	163 x 338 x 77 cm	60 x 42 cm
G	Elton Daybed	02-030-10	207 x 100 x 44 cm	44 cm
H	Elton Armchair	02-030-20	80 x 87 x 76 cm	45 x 47 cm
I	Elton Footstool	02-030-25	51 x 66 x 48 cm	47 cm
J	Elton Pouf	02-030-35	74 x 99 x 42 cm	42 cm

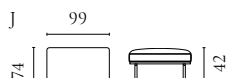
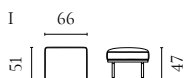
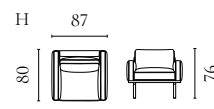
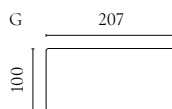
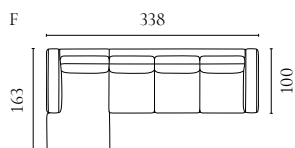
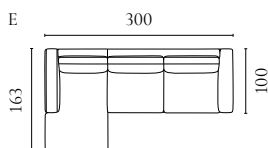
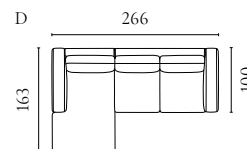
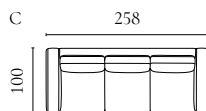
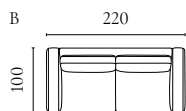
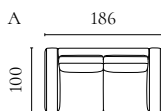

Veneda Sofa Series

Designed by *Bolia Design Team*



NUMBER	PRODUCT NAME	PRODUCT NUMBER	DEPTH x WIDTH x HEIGHT	SEAT DEPTH x HEIGHT
A	Veneda Sofa 2½ seater	01-096-01	102 x 192 x 81 cm	63 x 46 cm
B	Veneda Sofa 3 seater	01-096-05	102 x 240 x 81 cm	63 x 46 cm
C	Veneda Sofa 4 seater	01-096-10	102 x 277 x 81 cm	63 x 46 cm
D	Veneda Sofa 3½ seater with chaise longue - left / right	01-096-06 01-096-07	155 x 277 x 81 cm	63 x 46 cm
E	Veneda Sofa 4½ seater with chaise longue - left / right	01-096-15 01-096-16	155 x 349 x 81 cm	63 x 46 cm
F	Veneda Corner Sofa 6 seater	01-096-30	281 x 281 x 81 cm	63 x 46 cm
G	Veneda Pouf	02-096-01	112 x 112 x 46 cm	46 cm
H	Veneda Pouf	02-096-05	91 x 91 x 46 cm	46 cm

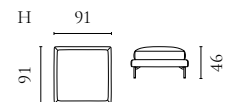
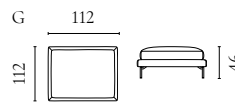
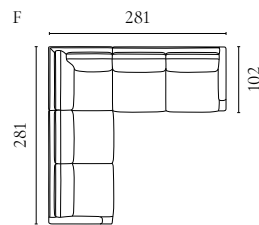
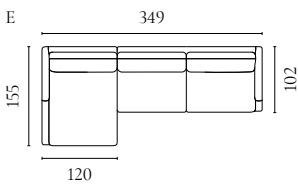
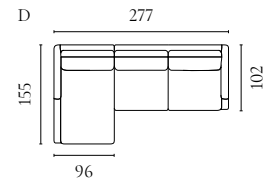
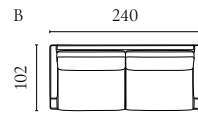
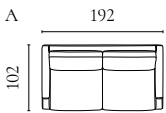

Lomi Sofa Series

Designed by *Meike Harde*



NUMBER	PRODUCT NAME	PRODUCT NUMBER	DEPTH x WIDTH x HEIGHT	SEAT DEPTH x HEIGHT
A	Lomi Sofa 2 seater	01-083-01	105 x 310 x 75 cm	70 x 48 cm
B	Lomi Sofa 2½ seater	01-083-05	105 x 310 x 75 cm	70 x 48 cm
C	Lomi Sofa 3 seater	01-083-10	105 x 310 x 75 cm	70 x 48 cm
D	Lomi Sofa 2½ seater with chaise longue - left / right	01-083-15 01-083-20	172 x 310 x 75 cm	70 x 48 cm
E	Lomi Corner Sofa 5 seater (2½ corner 2½)	01-083-25	105 x 310 x 75 cm	70 x 48 cm
F	Lomi Pouf	02-132-01	72 x 105 x 47 cm	48 cm

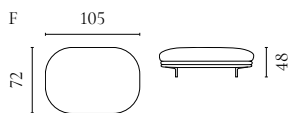
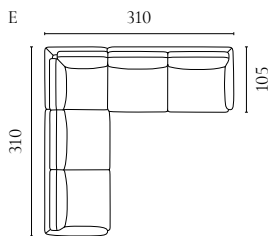
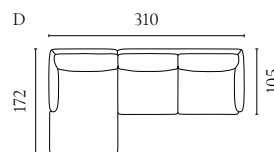
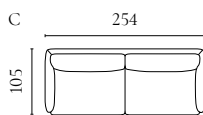
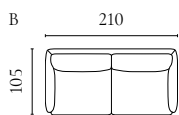
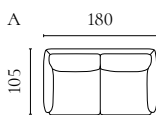

Caro Sofa Series

Designed by *kaschkasch*



NUMBER	PRODUCT NAME	PRODUCT NUMBER	DEPTH x WIDTH x HEIGHT	SEAT DEPTH x HEIGHT
A	Caro Sofa 2 seater	01-093-01	87 x 180 x 72 cm	60 x 42 cm
B	Caro Sofa 3 seater	01-093-03	87 x 220 x 72 cm	60 x 42 cm
C	Caro Corner Sofa 6 seater with open end - left / right	01-093-05 01-093-07	240 x 247 x 72 cm	60 x 42 cm
D	Caro Corner Sofa 7 seater with open end - left / right	01-093-10 01-093-15	240 x 287 x 72 cm	60 x 42 cm
E	Caro Corner Sofa 8 seater with open end - left / right	01-093-20 01-093-22	240 x 327 x 72 cm	60 x 42 cm
F	Caro Corner Sofa 5 seater - right / left	01-093-25 01-093-27	220 x 247 x 72 cm	60 x 42 cm
G	Caro Corner Sofa 6 seater (3 seater with corner unit - right / left)	01-093-30 01-093-32	260 x 247 x 72 cm	60 x 42 cm
H	Caro Corner Sofa 6 seater (3 seater with large corner unit - right / left)	01-093-35 01-093-37	220 x 287 x 72 cm	60 x 42 cm
I	Caro Corner Sofa 7 seater (3 seater with corner unit - right / left)	01-093-40 01-093-42	260 x 287 x 72 cm	60 x 42 cm
J	Caro Corner Sofa 7 seater (3 seater with large corner unit - right / left)	01-093-45 01-093-47	220 x 327 x 72 cm	60 x 42 cm
K	Caro Corner Sofa 8 seater - right / left	01-093-50 01-093-52	260 x 327 x 72 cm	60 x 42 cm
L	Caro Sofa 3 seater with chaise longue - left / right	01-093-55 01-093-57	160 x 260 x 72 cm	60 x 42 cm
M	Caro Sofa 4 seater with chaise longue - left / right	01-093-60 01-093-62	160 x 300 x 72 cm	60 x 42 cm
N	Caro Sofa 5 seater with chaise longue - left / right	01-093-65 01-093-67	160 x 340 x 72 cm	60 x 42 cm
O	Caro Pouf	02-093-01	73 x 100 x 42 cm	42 cm
P	Caro Pouf	02-093-05	60 x 87 x 42 cm	42 cm

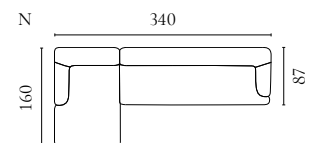
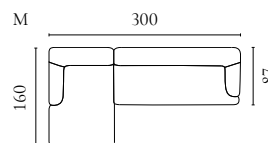
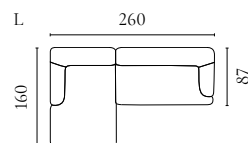
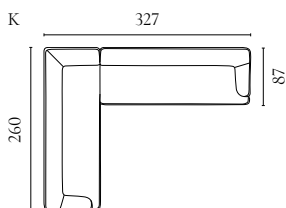
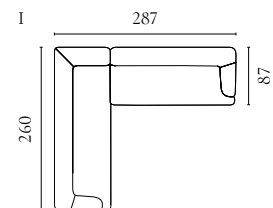
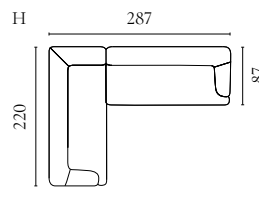
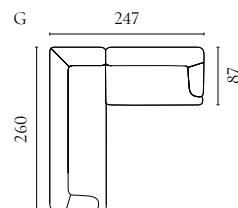
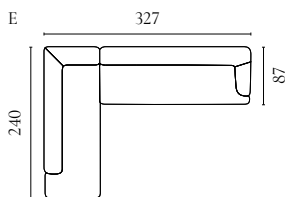
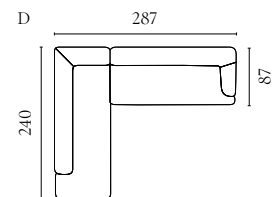
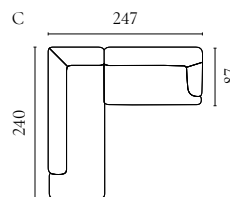
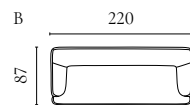
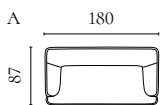

Malin Modular Sofa

Designed by Says Who



NUMBER	PRODUCT NAME	PRODUCT NUMBER	DEPTH x WIDTH x HEIGHT	SEAT DEPTH x HEIGHT
A	Malin Corner Unit with 6 back cushions - right / left	01-099-01 01-099-15	124 x 124 x 61 cm	110 x 40 cm
B	Malin Back Unit with 6 back cushions - large	01-099-20	124 x 112 x 61 cm	110 x 40 cm
C	Malin Back Unit with 4 back cushions - small	01-099-25	124 x 58 x 61 cm	110 x 40 cm
D	Malin Corner Unit with 2 back cushions - right / left	01-099-45 01-099-50	124 x 124 x 61 cm	110 x 40 cm
E	Malin Back Unit with 2 back cushions - large	01-099-55	124 x 112 x 61 cm	110 x 40 cm
F	Malin Back Unit with 2 back cushions - small	01-099-60	124 x 58 x 61 cm	110 x 40 cm
G	Malin Pouf	02-099-05	62 x 122 x 44 cm	40 cm
H	Malin Pouf	02-099-10	122 x 122 x 44 cm	40 cm
I	Malin 3 Units with back unit - 6 back cushions - small	00-099-30	124 x 306 x 61 cm	112 x 40 cm
J	Malin 3 Units with back unit - 6 back cushions - large	00-099-35	124 x 360 x 61 cm	112 x 40 cm
K	Malin 2 Units with 6 back cushions	00-099-40	124 x 248 x 61 cm	112 x 40 cm
L	Malin 3 Units with back unit - 2 back cushions - small	00-099-65	124 x 306 x 61 cm	112 x 40 cm
M	Malin 3 Units with back unit - 2 back cushions - large	00-099-70	124 x 360 x 61 cm	112 x 40 cm
N	Malin 2 Units with 2 back cushions	00-099-75	124 x 248 x 61 cm	112 x 40 cm

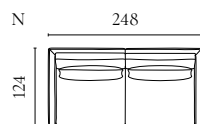
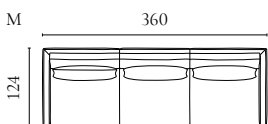
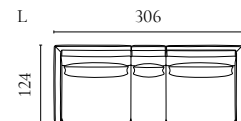
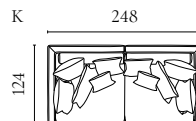
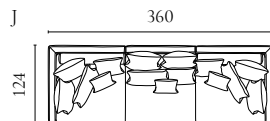
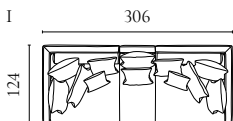
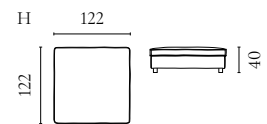
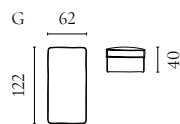
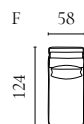
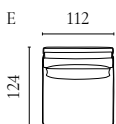
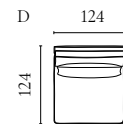
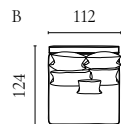
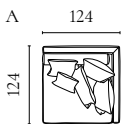

Cosy Modular Sofa

Designed by *Glismand & Rüdiger*



NUMBER	PRODUCT NAME	PRODUCT NUMBER	DEPTH x WIDTH x HEIGHT	SEAT DEPTH x HEIGHT
A	Cosy Back Unit with armrest - left / right	01-018-11 01-018-12	94 x 124 x 75 cm	63 x 44 cm
B	Cosy Back Unit	01-018-15	94 x 101 x 75 cm	63 x 44 cm
C	Cosy Chaise Longue without back - left / right	01-018-21 01-018-22	162 x 124 x 75 cm	63 x 44 cm
D	Cosy Chaise Longue with back - left / right	01-018-26 01-018-27	158 x 124 x 75 cm	63 x 44 cm
E	Cosy Corner Unit - long - left / right	01-018-28 01-018-29	94 x 154 x 75 cm	63 x 44 cm
F	Cosy Corner Unit - left / right	01-018-31 01-018-32	94 x 94 x 75 cm	63 x 44 cm
G	Cosy Back Unit with armrest - small - left / right	01-018-33 01-018-34	94 x 94 x 75 cm	63 x 44 cm
H	Cosy Footstool	02-018-10	65 x 106 x 44 cm	44 cm
I	Cosy 3 Units	00-018-01	94 x 349 x 75 cm	63 x 44 cm
J	Cosy 5 Units with corner	00-018-02	319 x 319 x 75 cm	63 x 44 cm
K	Cosy 3 Units with chaise longue - right / left	00-018-03 00-018-04	158 x 349 x 75 cm	63 x 44 cm

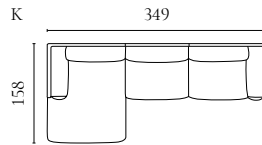
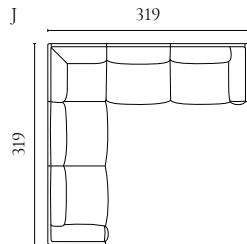
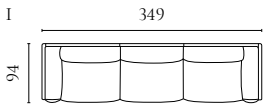
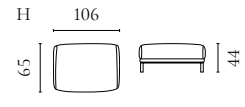
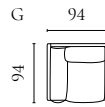
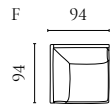
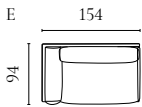
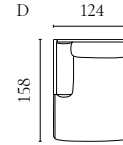
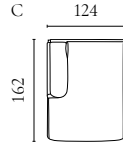
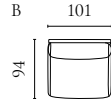
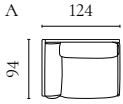

Orlando Modular Sofa

Designed by *Glismand & Rüdiger*



NUMBER	PRODUCT NAME	PRODUCT NUMBER	DEPTH x WIDTH x HEIGHT	SEAT DEPTH x HEIGHT
A	Orlando Corner Unit	01-006-86	100 x 100 x 64 cm	82 x 38 cm
B	Orlando Corner Unit	01-006-87	100 x 100 x 64 cm	82 x 38 cm
C	Orlando Back Unit	01-006-88	100 x 100 x 64 cm	82 x 38 cm
D	Orlando Pouf	01-006-89	100 x 100 x 38 cm	38 cm
E	Orlando 45 Back Unit	01-006-90	100 x 85 x 64 cm	82 x 38 cm
F	Orlando 45 Pouf	01-006-91	100 x 85 x 38 cm	38 cm
G	Orlando 50 Pouf	01-006-92	100 x 50 x 38 cm	38 cm
H	Orlando 50 Back Unit	01-006-93	100 x 50 x 64 cm	82 x 38 cm
I	Orlando 45 Back Unit	01-006-94	100 x 85 x 64 cm	82 x 38 cm
J	Orlando 3 Units	00-006-10	100 x 300 x 64 cm	82 x 38 cm
K	Orlando 3 Units with open end - left / right	00-006-11 00-006-12	100 x 300 x 64 cm	82 x 38 cm
L	Orlando 4 Units with chaise longue - right	00-006-13	200 x 300 x 64 cm	82 x 38 cm
M	Orlando Outdoor O2 Back Unit	01-008-01	100 x 100 x 67 cm	80 x 39 cm
N	Orlando Outdoor O2 Corner Unit - left / right	01-008-02 01-008-03	100 x 100 x 67 cm	80 x 39 cm
O	Orlando Outdoor O2 Pouf	02-008-01	100 x 100 x 39 cm	39 cm
P	Orlando Outdoor O2 Pouf	02-008-02	100 x 50 x 39 cm	39 cm
Q	Orlando Outdoor O2 2 Units	00-008-01	100 x 200 x 67 cm	80 x 39 cm
R	Orlando Outdoor O2 3 Units	00-008-02	100 x 300 x 67 cm	80 x 39 cm
S	Orlando Outdoor O2 4 Units	00-008-03	200 x 300 x 67 cm	80 x 39 cm
T	Orlando Outdoor O2 3 Units with open end - left / right	00-008-04 00-008-05	100 x 300 x 67 cm	80 x 39 cm

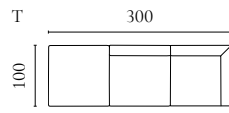
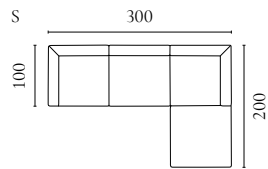
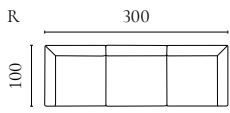
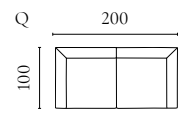
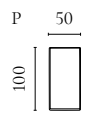
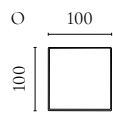
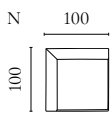
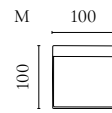
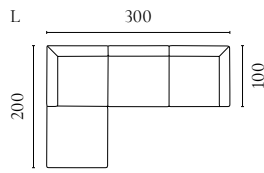
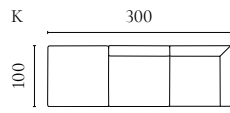
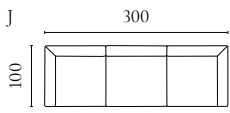
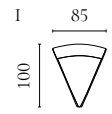
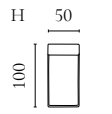
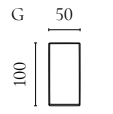
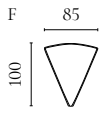
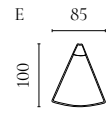
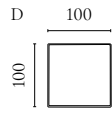
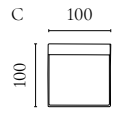
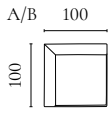

Sepia Sofa Series

Designed by *Glismand & Rüdiger*



NUMBER	PRODUCT NAME	PRODUCT NUMBER	DEPTH x WIDTH x HEIGHT	SEAT DEPTH x HEIGHT
A	Sepia Sofa 2½ seater	01-012-12	103,5 x 211 x 73 cm	68 x 40 cm
B	Sepia Sofa 3 seater	01-012-27	103,5 x 243 x 73 cm	68 x 40 cm
C	Sepia Sofa 3 seater with chaise longue - left / right	01-012-18 01-012-19	188 x 291 x 73 cm	68 x 40 cm
D	Sepia Corner Sofa 6 seater (2½ corner 2½)	01-012-32	103,5 x 290 x 73 cm	68 x 40 cm
E	Sepia Corner Sofa 7 seater (3 corner 3)	01-012-52	103,5 x 322 x 73 cm	68 x 40 cm
F	Sepia Corner Sofa 7 seater with chaise longue - left / right	01-012-58 01-012-59	103,5 x 368 x 73 cm	68 x 40 cm
G	Sepia Sofa 5 seater with open end - left / right	01-012-60 01-012-61	103,5 x 281 x 73 cm	68 x 40 cm
H	Sepia Pouf	02-025-07	70 x 85 x 40 cm	40 cm
I	Sepia Pouf	02-025-12	90 x 90 x 40 cm	40 cm
J	Sepia Pouf with storage	02-025-17	70 x 85 x 40 cm	40 cm
K	Sepia Pouf with storage	02-025-22	90 x 90 x 40 cm	40 cm

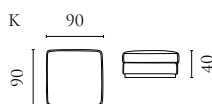
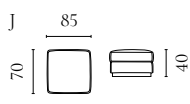
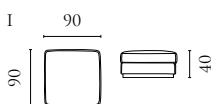
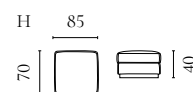
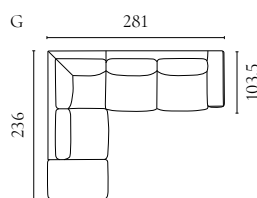
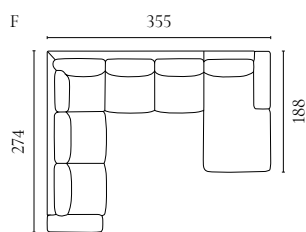
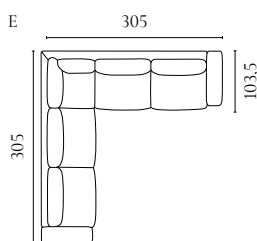
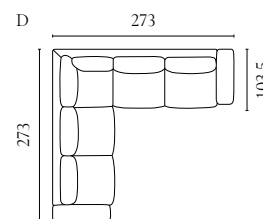
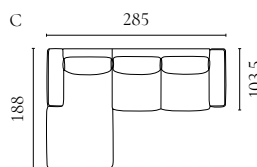
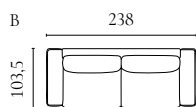
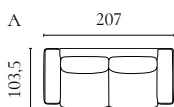

Jerome Modular Sofa

Designed by *kaschkasch*



NUMBER	PRODUCT NAME	PRODUCT NUMBER	DEPTH x WIDTH x HEIGHT	SEAT DEPTH x HEIGHT
A	Jerome Lounge Corner Unit with armrest - left / right	01-080-01 01-080-05	184 x 184 x 70 cm	162 x 47 cm
B	Jerome Corner Unit - left / right	01-080-06 01-080-07	103 x 184 x 70 cm	82 x 47 cm
C	Jerome Corner Unit - small	01-080-08	103 x 103 x 70 cm	82 x 47 cm
D	Jerome Back Unit with armrest - left / right	01-080-10 01-080-15	103 x 132 x 70 cm	82 x 47 cm
E	Jerome Chaise Longue - left / right	01-080-20 01-080-25	184 x 103 x 70 cm	162 x 47 cm
F	Jerome Back Unit - large	01-080-30	103 x 132 x 70 cm	82 x 47 cm
G	Jerome Back Unit - small	01-080-35	103 x 103 x 70 cm	82 x 47 cm
H	Jerome Daybed	01-080-40	103 x 206 x 47 cm	47 cm
I	Jerome Daybed Cushion	01-080-45	31 x 85 x 32 cm	
J	Jerome Pouf	02-129-01	103 x 103 x 47 cm	47 cm
K	Jerome Tray	02-129-02	78 x 18 x 3 cm	
L	Jerome 2 Units with lounge corner - armrest left / armrest right	00-080-01 00-080-02	184 x 316 x 70 cm	82 x 47 cm
M	Jerome 2 Units with chaise longue - armrest left / armrest right	00-080-03 00-080-04	184 x 235 x 70 cm	82 x 47 cm

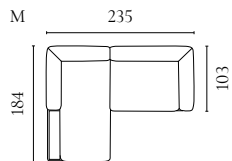
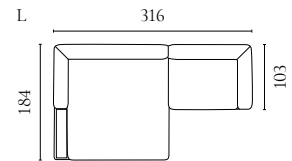
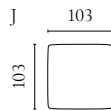
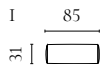
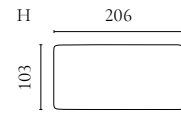
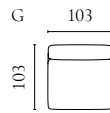
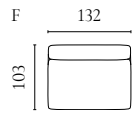
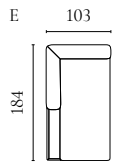
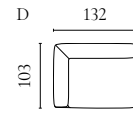
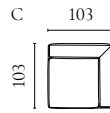
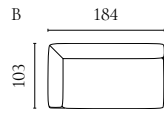
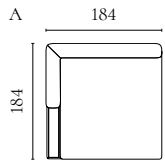

North Sofa Series

Designed by *Glismand & Rüdiger*



NUMBER	PRODUCT NAME	PRODUCT NUMBER	DEPTH x WIDTH x HEIGHT	SEAT DEPTH x HEIGHT
A	North Sofa 2½ seater	01-004-50	94 x 182 x 81 cm	64 x 45 cm
B	North Sofa 3 seater	01-004-55	94 x 215 x 81 cm	64 x 45 cm
C	North Sofa 3 seater with chaise longue - left / right	01-004-60 01-004-65	164 x 260 x 81 cm	64 x 45 cm
D	North Sofa 4 seater with chaise longue - left / right	01-004-70 01-004-75	164 x 295 x 81 cm	64 x 45 cm
E	North Corner Sofa 7 seater (3 corner 3)	01-004-80	304 x 304 x 81 cm	64 x 45 cm
F	North Corner Sofa 6 seater (2½ corner 2½)	01-004-85	271 x 271 x 81 cm	64 x 45 cm
G	North Corner Sofa 6 seater (2½ corner 3)	01-004-90	271 x 304 x 81 cm	64 x 45 cm
H	North Corner Sofa 6 seater (3 corner 2½)	01-004-95	304 x 271 x 81 cm	64 x 45 cm
I	North Pouf	02-004-30	90 x 94 x 45 cm	45 cm
J	North Pouf	02-004-25	70 x 72 x 45 cm	45 cm

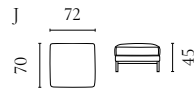
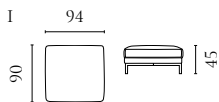
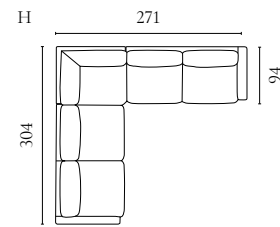
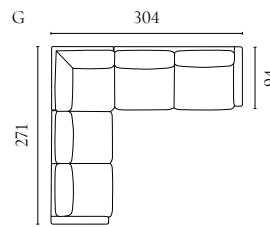
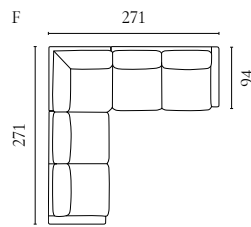
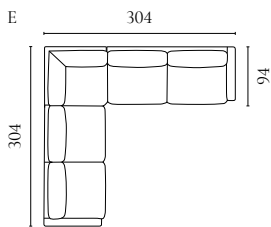
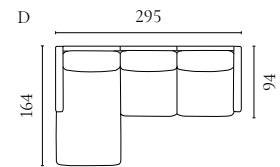
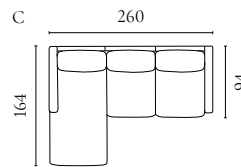
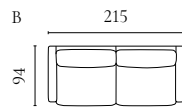
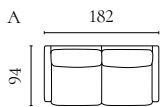

Caisa Modular Sofa

Designed by *BÖTTCHER & KAYSER*



NUMBER	PRODUCT NAME	PRODUCT NUMBER	DEPTH x WIDTH x HEIGHT	SEAT DEPTH x HEIGHT
A	Caisa 2 seater	01-081-01	91 x 182 x 73 cm	70 x 44 cm
B	Caisa 3 seater	01-081-05	91 x 242 x 73 cm	70 x 44 cm
C	Caisa 2 seater with open end - left / right	01-081-10 01-081-15	91 x 182 x 73 cm	70 x 44 cm
D	Caisa 3 seater open end - left / right	01-081-20 01-081-25	91 x 242 x 73 cm	70 x 44 cm
E	Caisa 3 seater with chaise longue - left / right	01-081-30 01-081-35	161 x 303 x 73 cm	70 x 44 cm
F	Caisa 4 seater with chaise longue - left / right	01-081-40 01-081-45	161 x 363 x 73 cm	70 x 44 cm
G	Caisa Chaise Longue - left / right	01-081-50 01-081-55	161 x 121 x 73 cm	70 x 44 cm
H	Caisa Back Unit with armrest - left / right	01-081-60 01-081-65	91 x 121 x 73 cm	70 x 44 cm
I	Caisa Corner Unit - left / right	01-081-70 01-081-75	91 x 91 x 73 cm	70 x 44 cm
J	Caisa Back Unit - large	01-081-80	91 x 121 x 73 cm	70 x 44 cm
K	Caisa Back Unit - small	01-081-85	91 x 91 x 73 cm	70 x 44 cm
L	Caisa Pouf - small	02-130-01	91 x 91 x 44 cm	91 x 44 cm
M	Caisa Pouf - large	02-130-05	91 x 121 x 44 cm	91 x 44 cm
N	Caisa 5 seater with corner	00-081-01	212 x 212 x 73 cm	70 x 44 cm
O	Caisa 6 seater with corner	00-081-02	273 x 273 x 73 cm	70 x 44 cm
P	Caisa 7 seater with corner	00-081-03	333 x 333 x 73 cm	70 x 44 cm

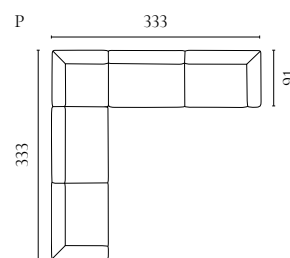
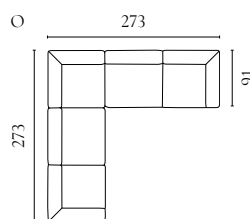
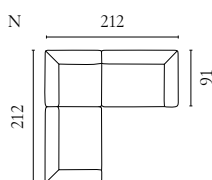
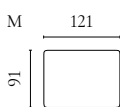
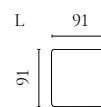
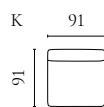
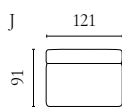
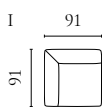
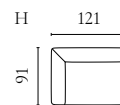
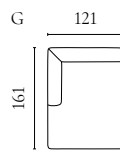
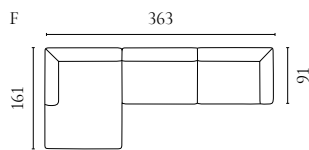
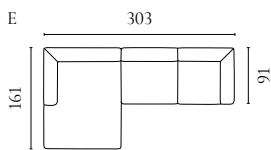
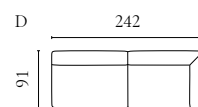
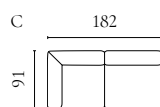
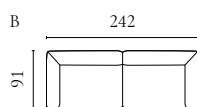
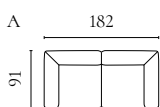

Paste Sofa Series

Designed by *BÖTTCHER & KAYSER*



NUMBER	PRODUCT NAME	PRODUCT NUMBER	DEPTH x WIDTH x HEIGHT	SEAT DEPTH x HEIGHT
A	Paste Sofa 2 seater	01-085-01	84 x 180 x 76 cm	60 x 42 cm
B	Paste Sofa 2½ seater	01-085-05	84 x 210 x 76 cm	60 x 42 cm
C	Paste Sofa 3 seater	01-085-10	84 x 240 x 76 cm	60 x 42 cm
D	Paste Sofa 3 seater with chaise longue - left / right	01-085-20 01-085-25	160 x 270 x 76 cm	60 x 42 cm
E	Paste Sofa 3½ seater with chaise longue - left / right	01-085-30 01-085-35	160 x 300 x 76 cm	60 x 42 cm
F	Paste Sofa 4 seater with chaise longue - left / right	01-085-40 01-085-45	160 x 330 x 76 cm	60 x 42 cm
G	Paste Pouf	02-085-10	90 x 70 x 42 cm	42 cm
H	Paste Pouf	02-085-20	90 x 90 x 42 cm	42 cm
I	Paste Footstool	02-085-35	48 x 68 x 42 cm	42 cm
J	Paste Armchair	02-085-30	74 x 86 x 76 cm	52 x 42 cm

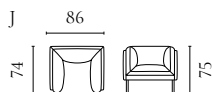
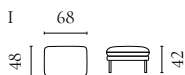
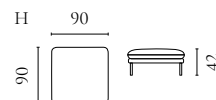
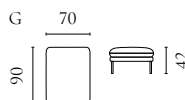
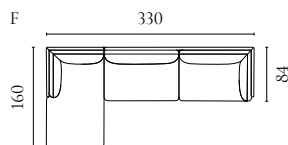
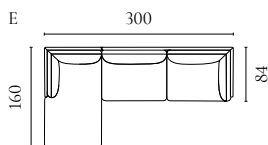
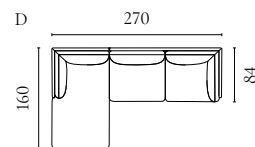
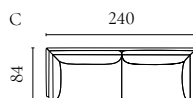
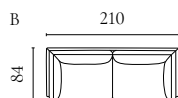
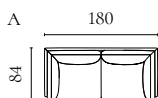

Angle Modular Sofa

Designed by Says Who



NUMBER	PRODUCT NAME	PRODUCT NUMBER	DEPTH x WIDTH x HEIGHT	SEAT DEPTH x HEIGHT
A	Angle Back Unit - small	01-045-01	86 x 68 x 66,5 cm	57 x 37 cm
B	Angle Back Unit - large	01-045-05	86 x 86 x 66,5 cm	57 x 37 cm
C	Angle Corner Unit - small - left / right	01-045-16 01-045-17	86 x 86 x 66,5 cm	57 x 37 cm
D	Angle Corner Unit - large - left / right	01-045-21 01-045-22	134 x 134 x 66,5 cm	57 x 37 cm
E	Angle Pouf - left / right	01-045-26 01-045-27	86 x 86 x 43 cm	37 cm
F	Angle Chaise Longue - left / right	01-045-30 01-045-35	86 x 116 x 66,5 cm	57 x 37 cm
G	Angle Corner Unit with chaise longue - left / right	01-045-40 01-045-45	150 x 86 x 66,5 cm	57 x 37 cm
H	Angle 3 Units with back unit - small	00-045-01	134 x 288 x 66,5 cm	57 x 37 cm
I	Angle 2 Units	00-045-02	134 x 268 x 66,5 cm	57 x 37 cm
J	Angle 3 Units with chaise longue	00-045-03	202 x 202 x 66,5 cm	57 x 37 cm
K	Angle 3 Units with corner unit - small	00-045-04	86 x 258 x 66,5 cm	57 x 37 cm
L	Angle 5 Units with chaise longue - right / left	00-045-05 00-045-06	318 x 306 x 66,5 cm	57 x 37 cm
M	Angle 3 Units with corner unit - large	00-045-07	134 x 354 x 66,5 cm	57 x 37 cm

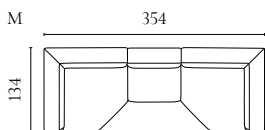
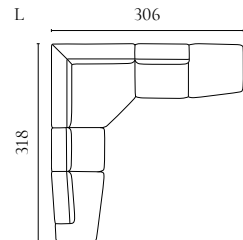
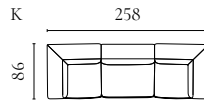
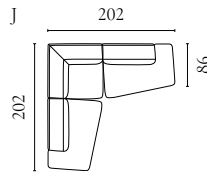
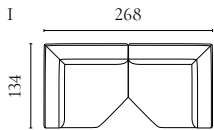
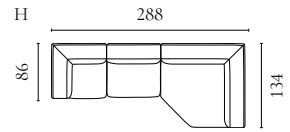
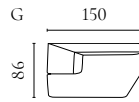
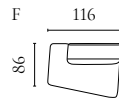
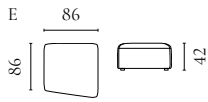
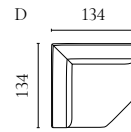
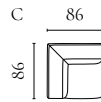
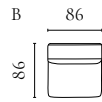
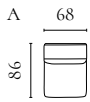

Cloud Sofa Series

Designed by *Yonoh Creative Studio*



NUMBER	PRODUCT NAME	PRODUCT NUMBER	DEPTH x WIDTH x HEIGHT	SEAT DEPTH x HEIGHT
A	Cloud Sofa 2 seater	01-058-01	82 x 162 x 75 cm	58 x 43 cm
B	Cloud Sofa 2½ seater	01-058-05	82 x 192 x 75 cm	58 x 43 cm
C	Cloud Sofa 3 seater	01-058-10	82 x 222 x 75 cm	58 x 43 cm
D	Cloud Armchair	02-097-01	82 x 102 x 75 cm	58 x 43 cm
E	Cloud Pouf	02-097-05	65 x 65 x 43 cm	43 cm
F	Cloud Pouf	02-097-10	65 x 122 x 43 cm	43 cm

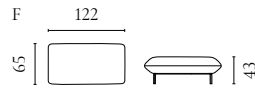
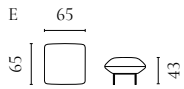
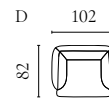
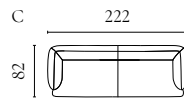
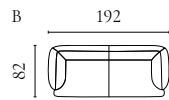
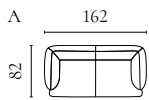

Pira Bed Sofa

Designed by *Joa Herrenknecht*



NUMBER	PRODUCT NAME	PRODUCT NUMBER	DEPTH x WIDTH x HEIGHT	SEAT DEPTH x HEIGHT
A	Pira Sofa Bed 2½ seater	01-089-01	102 x 176 x 81 cm	64 x 46 cm
B	Pira Sofa Bed 3 seater	01-089-05	102 x 196 x 81 cm	64 x 46 cm
C	Pira Sofa Bed 2½ seater with chaise longue and storage - right / left	01-089-10 01-089-15	170 x 262 x 81 cm	64 x 46 cm
D	Pira Sofa Bed 3 seater with chaise longue and storage - left / right	01-089-20 01-089-25	170 x 282 x 81 cm	64 x 46 cm
E	Pira Pouf with storage	02-136-01	72 x 87 x 46 cm	46 cm

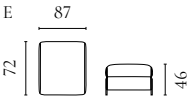
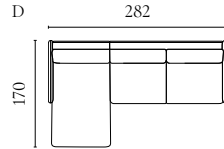
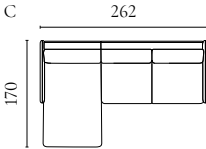
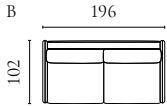
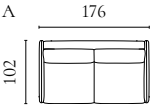



Sofas

Angle Modular Sofa	136-138, 261
Caro Sofa Series	1121-114, 251
Cloud Sofa Series	217, 262
Cosima Modular Sofa	14-16, 79-81, 83, 210-211, 244
Elton Sofa Series	30-33, 248
Lomi Sofa Series	120-124, 250
Malin Modular Sofa	8-10, 68-70, 176-179, 252
Noora Modular Sofa	56-57, 60-61, 142-144, 246
North Sofa Series	186-187, 189, 258
Orlando Outdoor O2 Modular Sofa	200-203, 254
Pira Sofa Bed Series	160-161, 263
Scandinavia Sofa Series	98-99, 101, 103-104, 240, 241
Scandinavia Remix Sofa Series	94-96, 100, 242
Sepia Sofa Series	168-170, 256
Veneda Sofa Series	44-45, 47, 129-131, 133, 249

Living room

Berlin Coffee Table & Bench Series	30-31, 34, 168-169, 171, 216
Bowie Armchair	15-16, 18-19, 57, 97, 169
Como Coffee Table Series	56-58, 68-69, 99-100, 129-131, 133, 176-177, 210-211
Cosh Armchair Series	69, 136, 142, 145, 176
Fuuga Nesting Armchair	216
Graceful Coffee Table	36, 61
Latch Coffee Table Series	80-81, 142-143, 145
Mix Coffee Table Series	94-95, 97, 123-125, 217
Visti Armchair	85, 94, 187, 190-191
Plateau Coffee Table Series	44-45, 160-161
Story Table Series	14-17, 85, 126-129.
Tuk Coffee Table Series	136-137, 139

Dining room

Alp Table & Bench Series	72-73, 75
Apelle Chair Series	63, 147
DoubleUp Dining Table	106-107, 109
Fusion Dining Table	20-21, 23
Graceful Table Series	36-39, 48-51, 128-129
Kimono Chair Series	180-181
Kite Chair	20-21, 88-89, 224-225
Link Table Series	210-211, 214-215, 220
Seed Chair Series	182, 204, 210-215, 221
Swing Chair	48-53, 128-129, 218-219, 222
Tab Coffee Table	112-113
Track Table Series	88-89, 180-182, 204
Tune Chair	106-107, 109
Turned Table Series	218-219

Bedroom

Haven Bed Series	154-157
------------------	---------

Office

Graceful Desk Series	222
Palm Chair Series	220

Storage

Cana Storage Series	148-149
Case Storage Series	180-181, 183
Cord Storage Series	162-163
Friedman Shelving System	30-31, 35, 186-188
House Storage Series	223
Luxe Storage Series	
Neutra Shelving System	38-39, 150, 210-211
Rod Shelving System	221
Trapeze Clothes Rack	150

Lamps

Acorn Lamp Series	20-21, 30-31, 34, 38-39, 100-101, 110-113, 218-219
Aluna Table Lamp	
Balloon Lamp Series	88-90, 122-123, 180-182, 217
Campa Lamp Series	44-45, 61, 62, 64-65
Donut Portable Lamp	203
Orb Lamp Series	48-51, 80-81, 85, 128-131, 150, 154-155, 176-177, 210-211, 214-215
Reflection Lamp Series	94-95, 160-161, 168-169, 171-173, 210-211, 220, 222
Scribe Table Lamp	221

Our beautiful world is evolving,
and with it, so are we.

In the fluidity of life,
we are becoming more aware
of the amazing opportunities we have,
the choices we make,
and the footprint we leave behind.
Like the nature that surrounds us
we are finding new, exciting ways to grow,
to soften the fixed structures that restrain us,
to liberate our creativity
and to view our life, our work
and our world with new eyes.

Allowing us to follow our passions,
live by our values,
be exactly who we are,
and love who we want to love.

Inviting us to make a change
towards something better.

Welcome to the ever-changing,
the fluid and the free.

CHANGE TO SOMETHING

This Lookbook is made from FSC® certified paper
and its climate footprint is equal to that of
1,26 average cheeseburgers*