

# Moa

SITS



# Moa

UPHOLSTERY

COMFORTS

COVERS

SPECIAL



fabric



STD standard



FC fixed



modular system

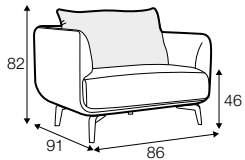

armchair

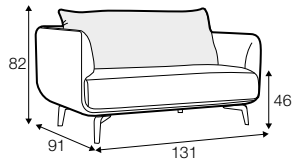

loveseat

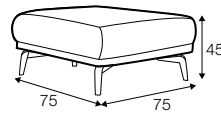

footstool 75x75

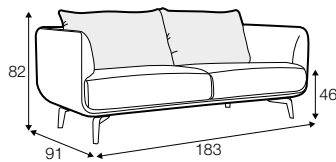

2 seater

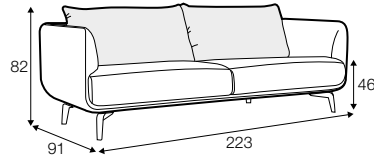

3 seater

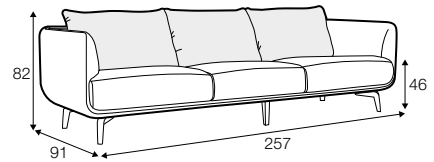

4 seater (divided)

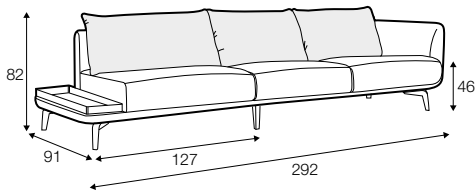

set 1 left / or right

2 seater right / or left + bench with tray left / or right

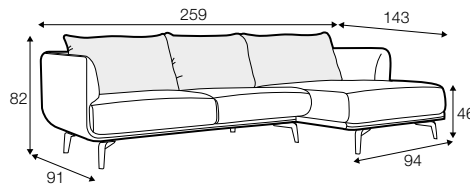

set 2 right / or left

2 seater left / or right + chaiselongue right / or left

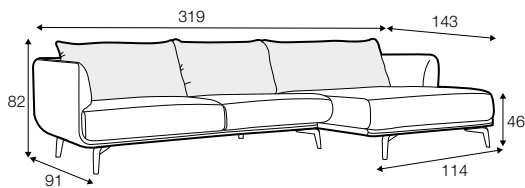

set 3 right / or left

3 seater left / or right + chaiselongue wide right / or left

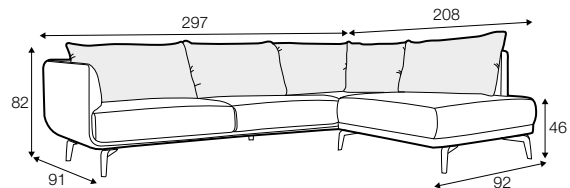

set 4 right / or left

3 seater left / or right + divan right / or left

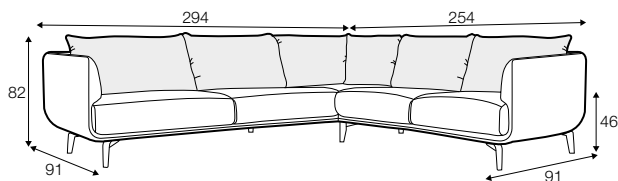

set 5 right / or left

3 seater left / or right + corner 90° + 2 seater right / or left

## modular system

---

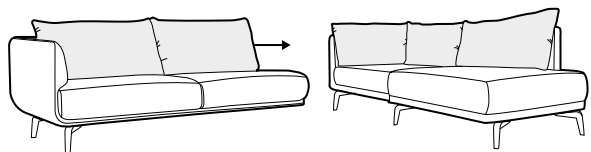

## elements of the modular system

---

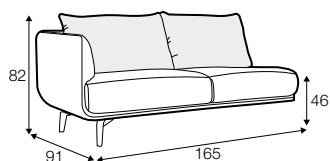

2 seater left / or right

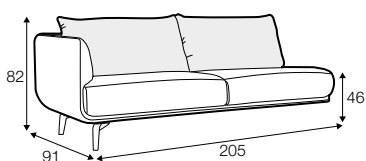

3 seater left / or right

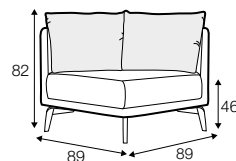

corner 90°

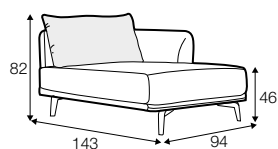

chaiselongue right / or left

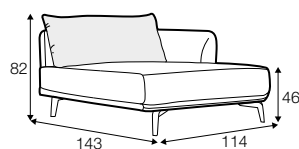

chaiselongue wide  
right / or left

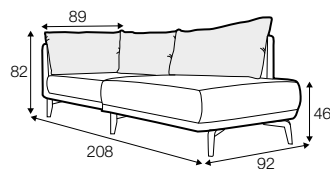

divan right / or left

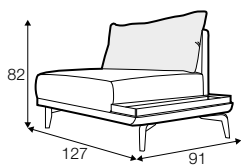

bench with tray right / or left

## extra dimensions

---

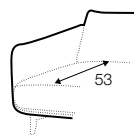

depth of seat

## legs

---

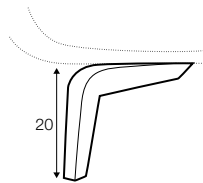

no. 200  
wood

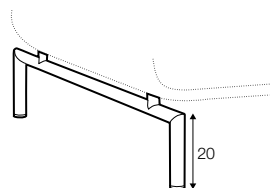

no. 199  
metal chrome,  
painted black or grey,  
brass gold  
and brushed steel

## available materials for tray

---



veneer: oak



veneer: white



veneer: black

## profile

---

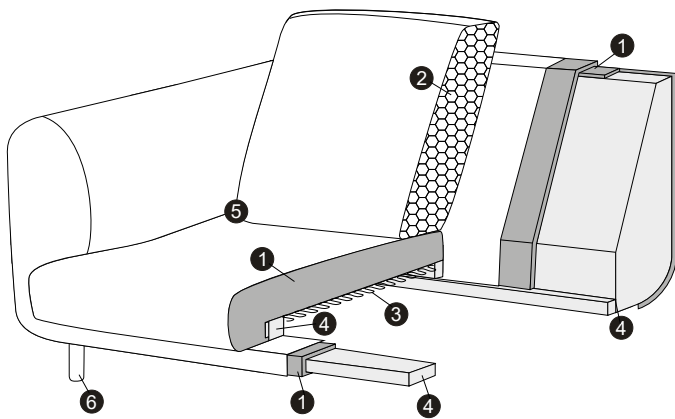

### standard

1. polyurethane foam / high resilient polyurethane foam
2. silicone balls
3. springs
4. FSC® certified solid wood and wood based elements
5. fabric
6. solid wood/metal legs