



GAZZDA

Fina storage

Product sheet

design by
Mustafa Čohadžić



reddot award 2018
winner



**BIGSEE
WOODDESIGN
AWARDWINNER
2018**



Fina storage units

Product facts

Materials

Body	Solid oak
Finish	Hardwax oil
Fronts	Furniture linoleum
Legs	Powder-coated steel

Technical features

Structural frame

Storage unit's body, as well as all inside shelves and drawers, are made of solid wood - oak, except storage unit back panel and drawer bottom panels which are made of high-density fiberboard.

Finish

Available in two plant-based Hardwax oil finishes (colours), which retain the wood's natural state, as a white or natural oil.

Fronts

Storage unit front panels are made out of linoleum (natural, warm to the touch, smooth, antibacterial surface material) glued on chipboard, framed with solid wood edges, and veneered from the inside. Desktop linoleum is available in two colours.

Legs

Steel legs are powder-coated in line with the chosen linoleum colour: Black RAL 9005 for Nero linoleum and Mushroom RAL 1013 for Mushroom linoleum. Legs have a wooden glider cap on their ends.

Cleaning

Please see [Product](#) or [Material](#) page on our website.

Notes to consider

Variations

Natural variations in wood color and surface may occur. Regular maintenance will ensure the wood preserves its authentic beauty and can last for generations.

Product changes

Please note that Gazzda reserves the right to alter construction and design without notice.

Dimensions (tolerances)

The dimensions shown are indicative, they may vary due to the natural properties of wood, season, or manufacturing processes. Deviations from the specified size may occur, usually no more than 1 cm.

For all additional inquiries regarding Fina storage units please feel free to [contact us](#).

Reference - Internal storage symbols

Space C - Compartment
D - Drawer
S - Shelf
CH - Cable hole

Position U - Upper
M - Middle
B - Bottom
R - Right
L - Left

Shape RC - Rectangular
CR - Circular

e.g. C-UR | Compartment - upper right
D-BL | Drawer - bottom left
CH-RC | Cable hole - rectangular

Shelves Shelves indicated with triangle arrows are height-adjustable and removable.

Fina lowboard 160

Body Solid oak, Fronts Linoleum, Legs Powder-coated steel

Version: 1-8-2021

Basic info

Design Mustafa Čohadžić

Product size W: 160, D: 45, H: 48

Packaging W: 163, D: 54, H: 34

Volume 0,30 m³

Net weight 47,4 kg

Gross weight 50,4 kg

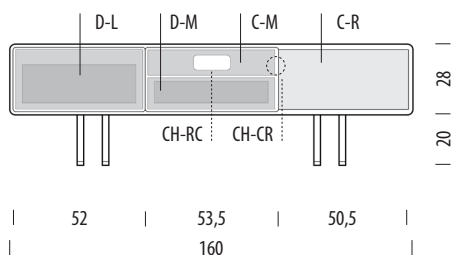

Item no. 19D

Assembly 15 min / 2 persons

Internal storage	Width	Depth	Height
D-L	45	34,5	15
D-M	43	34,5	8
C-M	51	41	9
C-R	51	41	23,5
CH-RC	14		5
CH-CR	Ø5		

Fina lowboard 200

Body Solid oak, Fronts Linoleum, Legs Powder-coated steel

Version: 1-8-2021

Basic info

Design Mustafa Čohadžić

Product size W: 200, D: 45, H: 48

Packaging W: 202, D: 54, H: 34

Volume 0,37 m³

Net weight 53,8 kg

Gross weight 57,3 kg

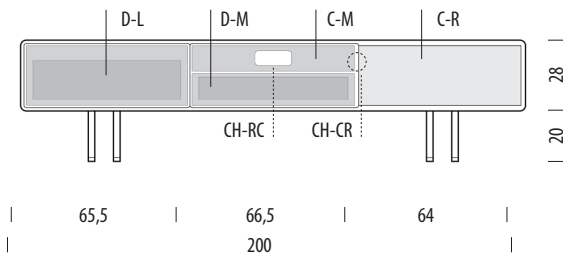

Item no. 066

Assembly 15 min / 2 persons

Internal storage	Width	Depth	Height
D-L	58	34,5	15
D-M	58	34,5	8
C-M	64	41	9
C-R	64	41	23,5
CH-RC	14		5
CH-CR	Ø5		

Selected options

Body

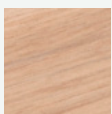

Oiled Oak
1015
White oil

Front panels



Linoleum
4176
Nero

Indicated materials and colours are selected by Gazzda as best-selling items. The lead time of selected options is 1-5 weeks. For an accurate lead time, please consult customer service.

For other material options, please see the Available materials section at the end of the product sheet.

Fina sideboard 150

Body Solid oak, Fronts Linoleum, Legs Powder-coated steel



Version: 1-8-2021

Basic info

Design Mustafa Čohadžić

Product size W: 150, D: 45, H: 64

Packaging W: 153, D: 54, H: 50

Volume 0,41 m³

Net weight 48,5 kg

Gross weight 52,5 kg

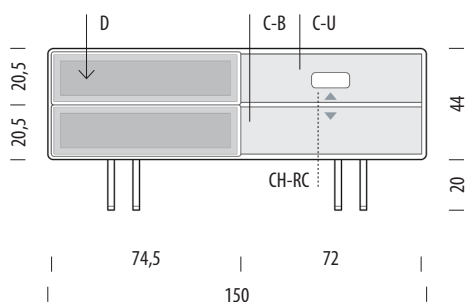

Item no. 19C

Assembly 15 min / 2 persons

Internal storage	Width	Depth	Height
D	68	34,5	12
C-U	72	40	19/22,5
C-B	72	40	15/18,5
CH-RC	14		5

- ▲ Shelves indicated with triangle arrows are height-adjustable and removable.

Fina sideboard 180

Body Solid oak, Fronts Linoleum, Legs Powder-coated steel



Version: 1-8-2021

Basic info

Design Mustafa Čohadžić

Product size W: 180, D: 45, H: 64

Packaging W: 183, D: 54, H: 50

Volume 0,49 m³

Net weight 58,3 kg

Gross weight 62,3 kg

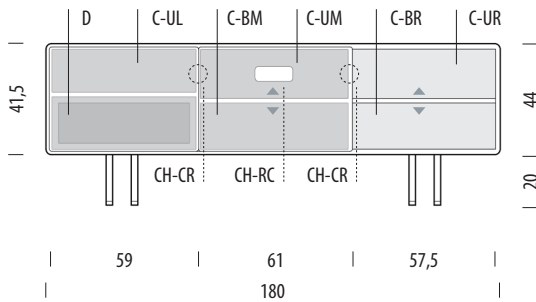

Pull-out shelf
(between C-UL and D)

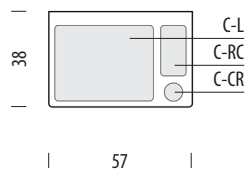

Item no. 065

Assembly 15 min / 2 persons

Internal storage	Width	Depth	Height
C-UL	57,5	41	19
D	53	34,5	15
C-UM	57,5	41	18/21,5
C-BM	57,5	41	16/19,5
C-UR	57,5	41	18/21,5
C-BR	57,5	41	16/19,5
CH-RC	14		5
CH-CR	Ø5		

Pull-out shelf

Internal storage	Width	Depth	Height
C-L (15" notebook size)	39	30	1
C-RC	10	20	1
C-CR	Ø7		1

▲ Shelves indicated with triangle arrows are height-adjustable and removable.

Selected options

Body

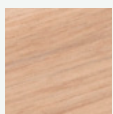

Oiled Oak
1015
White oil

Front panels



Linoleum
4176
Nero

Indicated materials and colours are selected by Gazzda as best-selling items. The lead time of selected options is 1-5 weeks. For an accurate lead time, please consult customer service.

For other material options, please see the Available materials section at the end of the product sheet.

Fina dresser 118 - with door

Body Solid oak, Fronts Linoleum, Legs Powder-coated steel

Version: 1-8-2021

Basic info

Design	Mustafa Čohadžić
Product size	W: 118, D: 45, H: 100
Packaging	W: 121,5, D: 54, H: 86
Volume	0,56 m ³
Net weight	51,8 kg
Gross weight	55,8 kg

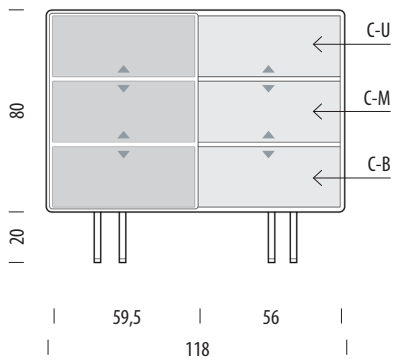

Item no. 19F

Assembly 15 min / 2 persons

Internal storage	Width	Depth	Height
C-U (each)	56	41	21-27
C-M (each)	56	41	17-31
C-B (each)	56	41	21-27

- ▲ Shelves indicated with triangle arrows are height-adjustable and removable.
- ▼

Fina dresser 118 - with drawers

Body Solid oak, Fronts Linoleum, Legs Powder-coated steel

Version: 1-8-2021

Basic info

Design	Mustafa Čohadžić
Product size	W: 118, D: 45, H: 100
Packaging	W: 121,5, D: 54, H: 86
Volume	0,56 m ³
Net weight	59,5 kg
Gross weight	63,5 kg

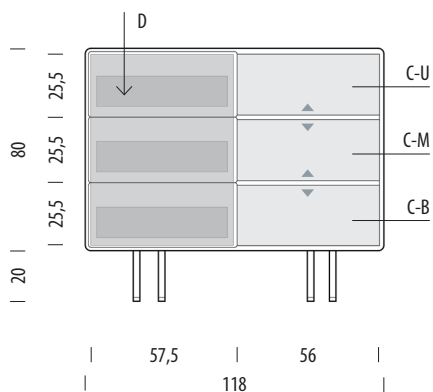

Item no. 1A0

Assembly 15 min / 2 persons

Internal storage	Width	Depth	Height
D (each)	51,5	34,5	12
C-U	56	41	21-27
C-M	56	41	17-31
C-B	56	41	21-27

▲ Shelves indicated with triangle arrows are height-adjustable and removable.

Fina dresser 176

Body Solid oak, Fronts Linoleum, Legs Powder-coated steel

Version: 1-8-2021

Basic info

Design Mustafa Čohadžić

Product size W: 176, D: 45, H: 100

Packaging W: 179, D: 54, H: 86

Volume 0,83 m³

Net weight 89,5 kg

Gross weight 94 kg

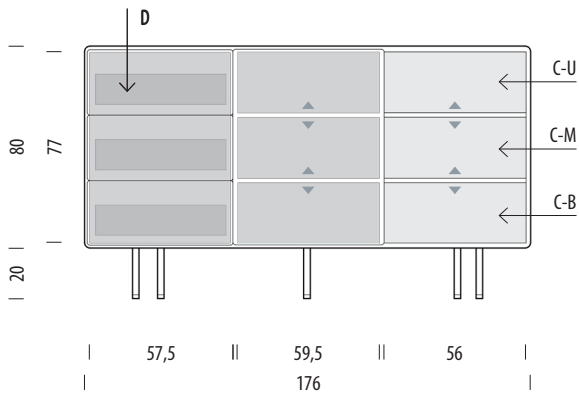

Item no. 19E

Assembly 15 min / 2 persons

Internal storage	Width	Depth	Height
D (each)	51,5	34,5	12
C-U (each)	56	41	21-27
C-M (each)	56	41	17-31
C-B (each)	56	41	21-27

▲ Shelves indicated with triangle arrows are height-adjustable and removable.

Fina drawer 60

Body Solid oak, Fronts Linoleum, Legs Powder-coated steel

Version: 1-8-2021

Basic info

Design	Mustafa Čohadžić
Product size	W: 60, D: 45, H: 100
Packaging	W: 63, D: 54, H: 86
Volume	0,29 m ³
Net weight	37,5 kg
Gross weight	41,1 kg

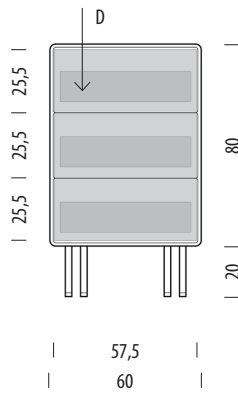

Item no. 067

Assembly 15 min / 2 persons

Internal storage	Width	Depth	Height
D (each)	51,5	34,5	12

Fina nightstand

Body Solid oak, Fronts Linoleum, Legs Powder-coated steel

Version: 1-8-2021

Basic info

Design	Mustafa Čohadžić
Product size	W: 55, D: 45, H: 40
Packaging	W: 58, D: 47,5, H: 26
Volume	0,07m ³
Net weight	15,3 kg
Gross weight	16,6 kg

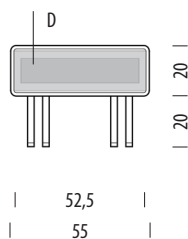

Item no. 068

Assembly 15 min / 1 person

Internal storage	Width	Depth	Height
D	46,5	34,5	10

Fina storage units

Available materials

Version: 1-8-2021

Body | Solid oak

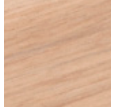

Oiled
1015
White oil

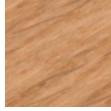

Oiled
1505
Natural oil

Plate | Desktop linoleum - by Forbo

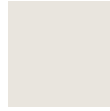

4176
Mushroom



4023
Nero