

**Petite  
Friture**

COLLECTION  
2022



PETITE FRITURE, LIBRE GARDE design editor, was founded 10 years ago by Amélie du Passage, placing bold, talented, emerging designers at the heart of its singular collections.

Its vocation: to arouse emotions that send out vibrations through time and space. Each project is born of an intuitive and optimistic encounter between designer, editor, and manufacturer.

Petite Friture is proud to take a stand, to seek out the best solutions at every step of the way, to use the right techniques and right people to better serve the planet and do something good.

From an effervescent blend comes a sense of drive, a desire to work towards something sincere.

Transparency, respect, dialogue - our brand is one that seeks a sustainable future for decades to come. Petite Friture is more than just a design editor, it is a state of mind grounded in trust and optimism. Its ambition is to create virtuous beauty that will last for many years to come.

NEW

LED LIGHTING



OUASAR  
SAMY RID



MEDITERRANEA  
NOË DUCHAUFOUR-LAWRANCE



VERTIGO NOVA  
CONSTANCE GUISSET



UNSEEN  
STUDIO PEPE



CHERRY  
DANIEL + EMMA



LIGHTING



VERTIGO  
CONSTANCE GUISSET



LANTERNA  
SAM BARON



SO-SAGE  
SAM BARON



TIDLIGHT  
PIERRE FAVRESSE



GRILLO  
ELISE FOJN



FURNITURE



TAVLA  
POOL



UNIFY  
ANNE HARVALA

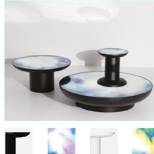

PARROT  
INDIA MAHDVI

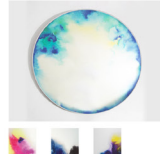

FRANCIS  
CONSTANCE GUISSET

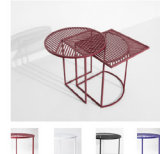

FRANCIS  
CONSTANCE GUISSET



ISO-A & B  
POOL



FROMME  
TOM CHUNG



FROMME SOFT  
TOM CHUNG



TRAME  
AC/AL STUDIO



HOFF  
MORTEN & JONAS



NUBILLO  
CONSTANCE GUISSET



GRID  
POOL



LILY  
FÄRGSBLANCHE

NEW

OUTDOOR



WEEK-END  
STUDIO BRICHTZIEGLER



DECORATION



SUCCESSION  
FÄRGS & BLANCHE x PETITE FRITURE & REVOL

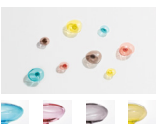

BUBBLE  
VAULOT & D'YVÈRE



PING  
ANDRÁS RIGLER



DONUTS  
PIA CHEVALIER

NEW

WALL COVERING



VARIATIONS WALLPAPERS  
TIPHAINE DE BODMAN

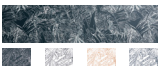

JUNGLE WALLPAPERS  
TIPHAINE DE BODMAN



VOLUTES WALLPAPERS  
TIPHAINE DE BODMAN

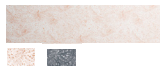

DOTS WALLPAPERS  
SHELLEY STEER

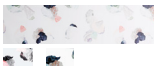

MINERALS WALLPAPERS  
SHELLEY STEER



CONSTELLATION WALLPAPERS  
LESLIE DAVID



UTOPIA ASCENDING  
WALLPAPERS  
ANA MONTIEL

# *Collection*

## **01 LED LIGHTING**

---

*P. 6*

## **02 LIGHTING**

---

*P. 29*

## **03 FURNITURE**

---

*P. 38*

## **04 UPHOLSTERY**

---

*P. 70*

## **05 OUTDOOR**

---

*P. 95*

## **06 DECORATION**

---

*P. 116*

**LED LIGHTING**







# QUASAR

## SAMY RIO

2021



Black



Natural



Sienna



Olive green



Emerald green

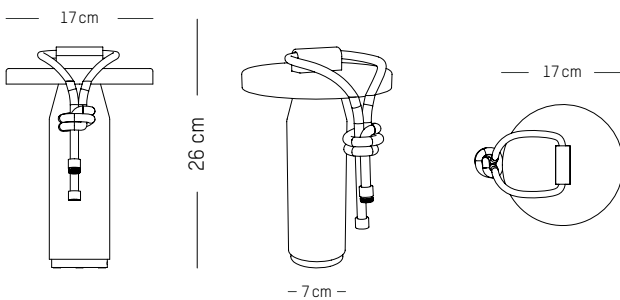

### Small

**Ø TOP:** 17 cm | 6.7 inch  
**Ø BOTTOM:** 7 cm | 2.8 inch  
**H:** 26 cm | 10.1 inch  
**Weight:** 1,3 kg | 2.9 lb

#### PACKAGING (pack cash and carry)

**L:** 18 cm | 7.1 inch  
**W:** 18 cm | 7.1 inch  
**H:** 29 cm | 11.4 inch  
**Weight:** 2 kg | 4.4 lb

### Indoor/Outdoor lamp

#### MATERIALS

Anodized aluminium, PC, ABS and polyester.

#### COLORS

Natural aluminium, Sienna, Black, Emerald green, Olive green.

#### ORIGIN

CHINA

#### TECHNICAL SPECIFICATIONS



3 light intensities (100%, 50%, 25%)

LED input:  
250 lumens

LED output:  
150 lumens

# CHERRY

## DANIEL ET EMMA

2021

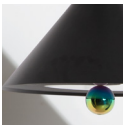

Black and rainbow



White and gold



Brown-red and rose gold



Mint-green and titanium

### Pendant lamp

-

#### MATERIALS

Aluminium, matt grained powder coating; mirror finish steel; disseminating fire resistant plexiglass; Fabric cable, white or black, 3m /118.1 inch; steel ceiling cup white or black ; Integrated LED

#### COLORS

Black and rainbow, white and gold, red brown and rose gold, mint green and titanium

#### ORIGIN

France

#### TECHNICAL SPECIFICATIONS



LED input:  
1040 lumens



Integrated LED



EUROPE

UK

US



Power

220-240V, 50-60Hz

Power

220-240V, 50-60Hz

Power

110-120V, 60Hz



#### XS

-

**D:** 9,3 cm | 3.6 inch  
**H:** 17 cm | 6.7 inch  
**Ø (sphere):** 5,1 cm | 0.2 inch  
**Canopy:** Ø 15cm | 5.9 inch  
**Weight:** 0,9 kg | 2 lb

#### PACKAGING :

**Type:** Carton box  
**L:** 19,6 cm | 8 inch  
**W:** 19,6 cm | 8 inch  
**H:** 24,4 cm | 9.7 inch  
**Weight:** 1,4 kg | 3 lb

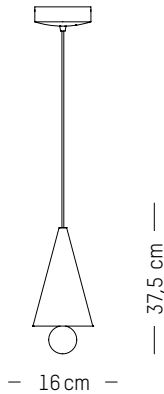

#### S

-

**D:** 16 cm | 6.3 inch  
**H:** 37,5 cm | 15 inch  
**Ø (sphere):** 7,6 cm | 0.3 inch  
**Canopy:** Ø 15cm | 5.9 inch  
**Weight:** 1,2 kg | 2.7 lb

#### PACKAGING :

**Type:** Carton box  
**L:** 22,5 cm | 9 inch  
**W:** 22 cm | 8.6 inch  
**H:** 50 cm | 17 inch  
**Weight:** 1,8 kg | 4 lb

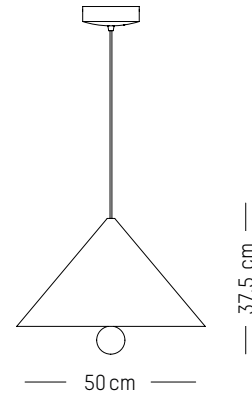

#### L

-

**D:** 50 cm | 19.7 inch  
**H:** 37,5 cm | 15 inch  
**Ø (sphere):** 7,6 cm | 0.3 inch  
**Canopy:** Ø 15cm | 5.9 inch  
**Weight:** 2,5 kg | 5.5 lb

#### PACKAGING :

**Type:** Carton box  
**L:** 58,5 cm | 23 inch  
**W:** 58,5 cm | 23 inch  
**H:** 51 cm | 17.5 inch  
**Weight:** 5,450 kg | 12.2 lb

# CHERRY

DANIEL ET EMMA

2021



White

## Linear canopy configuration

### MATERIALS

Steel, matt grained powder coating; Aluminium, matt grained powder coating; mirror finish steel; disseminating fire resistant plexiglass; Fabric cable, white or black, 3m /118.1 inch; steel ceiling cup white or black; Integrated LED  
5 outputs for Cherry pendant light  
Mounting bracket system  
Plastic caps to hide non used outputs

### COLORS

White

### ORIGIN

France

2 POSSIBLE CONFIGURATIONS :

5 PCS XS CHERRY PENDANT OR 3 PCS S CHERRY PENDANT

### TECHNICAL SPECIFICATIONS

#### 5X OR 3X

LED 24V~7.8 W LED input: 1040 lumens

1 P 2 0

Integrated LED



EUROPE

UK

CE

CE

Power

220-240V, 50-60Hz

Power

220-240V, 50-60Hz

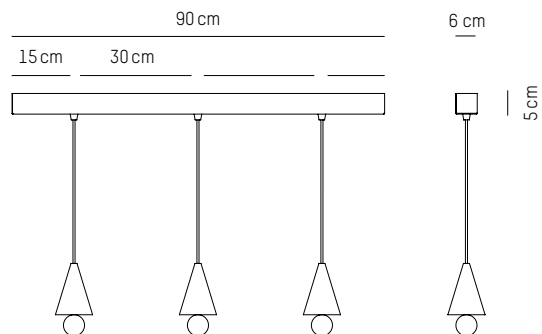
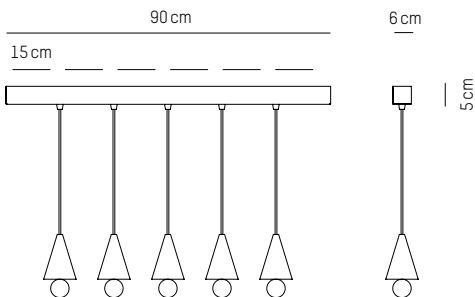

## Linear canopy

5 PCS XS CHERRY PENDANT

L: 90 cm | 35 inch  
W: 6 cm | 2.4 inch  
H: 5 cm | 1.9 inch  
Weight: 3,9 kg | 8.6 lb

### PACKAGING :

Type: Carton box  
L: 91 cm | 35.6inch  
W: 17 cm | 6.6 inch  
H: 27 cm | 10.6 inch

## Linear canopy

3 PCS S CHERRY PENDANT

L: 90 cm | 35 inch  
W: 6 cm | 2.4 inch  
H: 5 cm | 1.9 inch  
Weight: 3,4 kg | 7.5 lb

### PACKAGING :

Type: Carton box  
L: 91 cm | 35.6inch  
W: 17 cm | 6.6 inch  
H: 27 cm | 10.6 inch



# CHERRY

DANIEL ET EMMA

2021



White

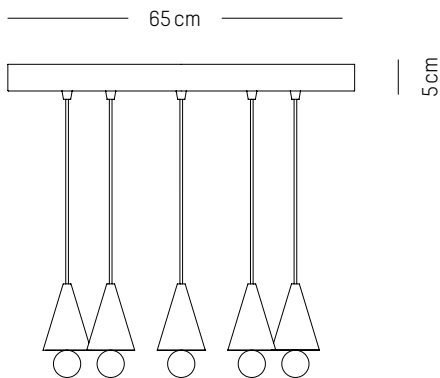

## Round canopy

**Ø:** 65 cm | 25.6 inch  
**H:** 5 cm | 2 inch  
**Weight:** 5,9 kg | 13 lb

### PACKAGING :

**Type:** Carton box  
**L:** 67 cm | 26.5 inch  
**W:** 66 cm | 26 inch  
**H:** 27 cm | 10.06 inch  
**Weight:** 8 kg | 17.7 lb

## Round canopy configuration

### MATERIALS

Steel, matt grained powder coating; Aluminium, matt grained powder coating; mirror finish steel; disseminating fire resistant plexiglass; Fabric cable, white or black, 33m /118.1 inch; steel ceiling cup white or black; Integrated LED  
5 outputs for Cherry pendant light  
Mounting bracket system  
Plastic caps to hide non used outputs

### COLORS

White

### ORIGIN

France

1 POSSIBLE CONFIGURATIONS :  
5 PCS XS CHERRY PENDANT

### TECHNICAL SPECIFICATIONS

5X

LED  
24V~7.8 W

LED input:  
1040 lumens

1 P  
2 0

Integrated LED



EUROPE

UK

CE

CE

Power

220-240V, 50-60Hz

Power

220-240V, 50-60Hz

# UNSEEN

## STUDIO PEPE

2020



### Pendant lamps

#### MATERIALS

Smooth powder coated steel, varnished brass, polycarbonate tube

Lighting system: integrated LED

#### COLORS

Brass and translucent

#### ORIGIN

France

#### TECHNICAL SPECIFICATIONS

##### TRIPLE PENDANT

**LED**  
28W LED input:  
2410 lumens

##### QUINTUPLE PENDANT

**LED**  
48.2W LED input:  
4730 lumens

**IP**  
20

**Dimmable**

**2700K**

EUROPE

UK

US

**CE**

**CE**

**UL** US

Power  
220-240 V 50-60HZ

Power  
220-240 V 50-60 HZ

Power  
110-120 V 60 HZ

12

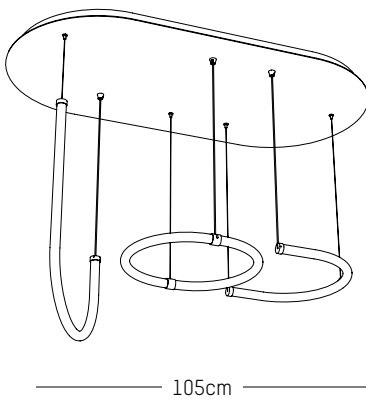

### Triple pendant system

**L:** 105 cm | 41.3 inch  
**W:** 53 cm | 21 inch  
**H:** 82 cm | 33 inch  
**Weight:** 15 kg | 33 lb

#### PACKAGING :

**L:** 86,7 cm | 34.1 inch  
**W:** 115 cm | 45.3 inch  
**H:** 58 cm | 26.8 inch  
**Weight:** 17 kg | 37.5 lb

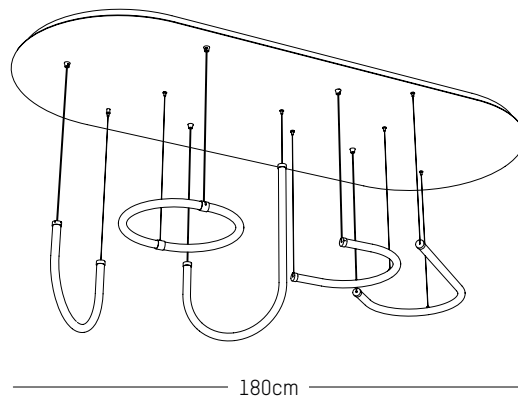

### Quintuple pendant system

**L:** 180 cm | 70.9 inch  
**W:** 73 cm | 29 inch  
**H:** 82 cm | 32.3 inch  
**Weight:** 40 kg | 88.2 lb

#### PACKAGING :

**L:** 86,7 cm | 34.1 inch  
**W:** 200 cm | 78.7 inch  
**H:** 83 cm | 32.7 inch  
**Weight:** 50 kg | 110.2 lb

# UNSEEN

STUDIO PEPE

2020



## Wall lamp

-

### MATERIALS

Smooth powder coated steel, varnished brass, polycarbonate tube

Lighting system: integrated LED

### COLORS

Brass and translucent

### ORIGIN

France

### TECHNICAL SPECIFICATIONS



LED input:  
660 lumens



EUROPE

UK

US



Power

220-240 V 50-60HZ

Power

220-240 V 50-60 HZ

Power

110-120 V 60 HZ

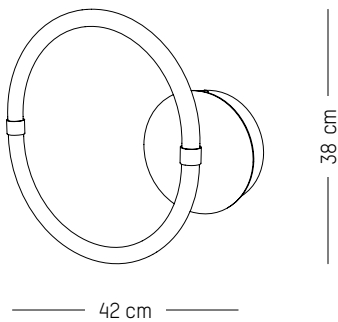

## Wall Lamp 0

-

**L:** 42 cm | 16.5 inch

**D:** 7 cm | 2.8 inch

**H:** 38 cm | 14.9 inch

**Weight:** 1,4 kg | 3.1 lb

### PACKAGING :

**L:** 46,7 cm | 18.4 inch

**W:** 42,7 cm | 16.7 inch

**H:** 68 cm | 26.7 inch

**Weight:** 3 kg | 6.6 lb

# UNSEEN

STUDIO PEPE

2020

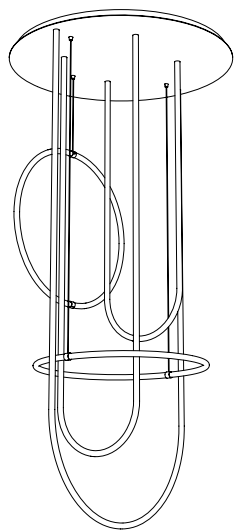
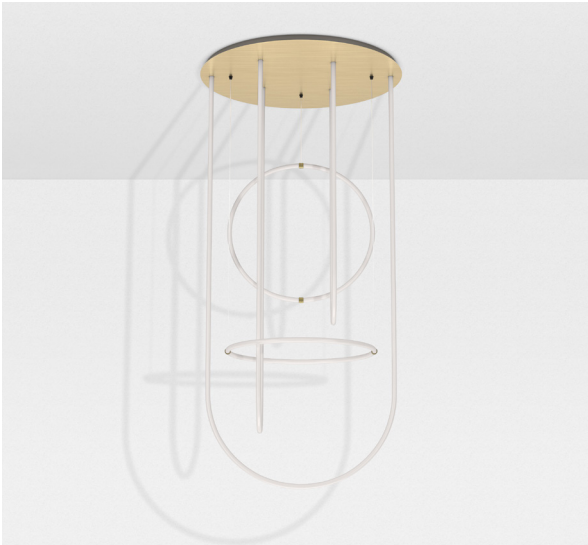

100 cm

**L:** 100 cm | 40 inch  
**H:** 210 cm | 82.7 inch  
**Weight:** 27 kg | 59.5 lb

### PACKAGING :

**L:** 150 cm | 59 inch  
**W:** 250 cm | 98 inch  
**H:** 83 cm | 33 inch  
**Weight:** 50 kg | 110 lb

## Chandelier

-

### MATERIALS

Smooth powder coated steel, varnished brass, polycarbonate tube

Lighting system: integrated LED

### COLORS

Brass and translucent

### ORIGIN

France

### TECHNICAL SPECIFICATIONS



LED input:  
15883 lumens



EUROPE

UK

US



Power  
220-240 V 50-60HZ

Power  
220-240 V 50-60 HZ

Power  
110-120 V 60 HZ

# UNSEEN

## STUDIO PEPE

2020



### Table lamps

-

#### MATERIALS

Smooth powder coated steel, varnished brass, polycarbonate tube

Lighting system: integrated LED

#### COLORS

Brass and translucent

#### ORIGIN

France

#### TECHNICAL SPECIFICATIONS

##### SMALL

**LED**  
7.8W LED input:  
670 lumens

##### LARGE

**LED**  
16W LED input:  
1650 lumens

**IP**  
20

Dimmable

2200K 2700K 3000K 3500K 4000K

EUROPE

UK

US

CE

CE

UK PLUS

cUL US

Power

220-240 V 50-60HZ

Power

220-240 V 50-60 HZ

Power

110-120 V 60 HZ

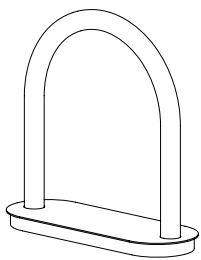

28 cm

### Small table lamp

-

**L:** 28 cm | 11 inch

**H:** 28 cm | 11 inch

**D:** 10 cm | 4 inch

**Weight:** 1,5 kg | 3.3 lb

**Cable length:** 175cm | 68.9 inch

#### PACKAGING :

**L:** 31 cm | 12.2 inch

**W:** 15 cm | 5.9 inch

**H:** 32 cm | 12.6 inch

**Weight:** 3 kg | 6.6 lb

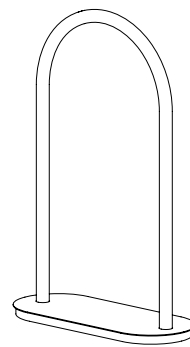

40 cm

### Large table lamp

-

**L:** 40 cm | 16 inch

**H:** 60 cm | 23.7 inch

**D:** 16,5 cm | 7 inch

**Weight:** 3 kg | 6.6 lb

**Cable length:** 175cm | 68.9 inch

#### PACKAGING :

**L:** 70 cm | 27.6 inch

**W:** 20 cm | 8 inc

**H:** 70 cm | 27.6 inch

**Weight:** 5 kg | 11 lb

# UNSEEN

## STUDIO PEPE

2020



Pendant lamp U



Pendant lamp O

### Pendant lamps

-

#### MATERIALS

Smooth powder coated steel, varnished brass, polycarbonate tube

Lighting system: integrated LED

#### COLOURS

Brass and translucent

#### ORIGIN

France

#### TECHNICAL SPECIFICATIONS

For recess ceiling

##### LAMP J

LED  
12W

LED input:  
1030 lumens

##### LAMP O

LED  
7.6W

LED input:  
660 lumens

##### LAMP U

LED  
8.5W

LED input:  
720 lumens



EUROPE

UK



Power

220-240 V 50-60HZ

Power

220-240 V 50-60 HZ

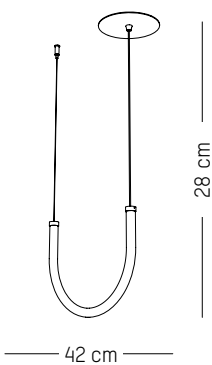

### Pendant lamp U

-

**L:** 42 cm | 16.5 inch  
**D:** 2,4 cm | 1 inch  
**H:** 28 cm | 11 inch  
**Weight:** 0,96 kg | 2.12 lb  
**Cable length (max):** 2,5 m | 99 inch

#### PACKAGING :

**L:** 46,7 cm | 18.4 inch  
**W:** 42,6 cm | 16.8 inch  
**H:** 6,8 cm | 2.7 inch  
**Weight:** 1,9 kg | 4.2 lb

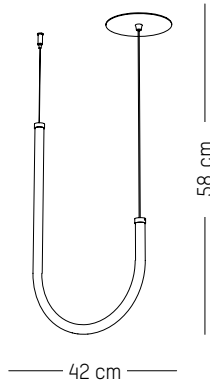

### Pendant lamp J

-

**L:** 42 cm | 16.5 inch  
**D:** 2,4 cm | 1 inch  
**H:** 58 cm | 22.8 inch  
**Weight:** 1,5 kg | 3.3 lb  
**Cable length (max):** 2,5 m | 99 inch

#### PACKAGING :

**L:** 62,5 cm | 24.6 inch  
**W:** 46,7 cm | 18.4 inch  
**H:** 6,8 cm | 2.7 inch  
**Weight:** 2,5 kg | 5.5 lb

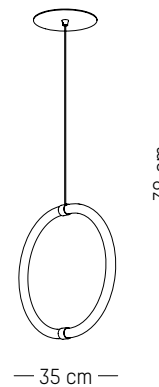

### Pendant lamp O

-

**L:** 35 cm | 14 inch  
**D:** 2,4 cm | 1 inch  
**H:** 38 cm | 17.8 inch  
**Weight:** 1,4 kg | 3.1 lb  
**Cable length (max):** 2,5 m | 99 inch

#### PACKAGING :

**L:** 46,7 cm | 18.4 inch  
**W:** 42,6 cm | 16.8 inch  
**H:** 6,8 cm | 2.7 inch  
**Weight:** 2,5 kg | 5.5 lb

# UNSEEN

STUDIO PEPE

2020



## Pendant lamps canopy

-

### MATERIALS

Varnished brass

### COLOUR

Brass

### ORIGIN

France

### TECHNICAL SPECIFICATIONS

To combine with unit pendant lamp for regular ceiling

🇪🇺 EUROPE

🇬🇧 UK

CE

CE

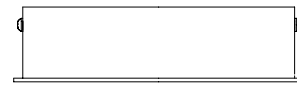
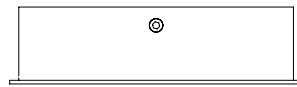
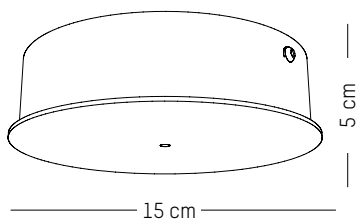

## Pendant lamp canopy

-

Ø: 15 cm | 5.9 inch

H: 5 cm | 2 inch

Weight: 0,9 kg | 2 lb

### PACKAGING :

L: 15 cm | 5.9 inch

W: 15 cm | 5.9 inch

H: 16 cm | 6.3 inch

Weight: 1,1 kg | 2.43 lb

# UNSEEN

## STUDIO PEPE

2020



Pendant lamp U



Pendant lamp O

### Pendant lamps

-

#### MATERIALS

Smooth powder coated steel, varnished brass, polycarbonate tube

Lighting system: integrated LED

#### COLOURS

Brass and translucent

#### ORIGIN

France

#### TECHNICAL SPECIFICATIONS

Can be used on recess and regular ceilings

##### LAMP J

**LED 12W** LED input: 1030 lumens

##### LAMP O

**LED 7.6W** LED input: 660 lumens

##### LAMP U

**LED 8.5W** LED input: 720 lumens



#### Power

110-120 V 60 HZ

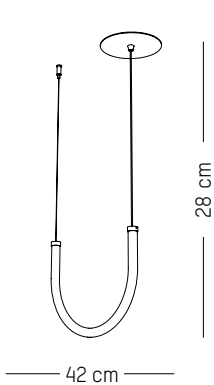

### Pendant lamp U

**L:** 42 cm | 16.5 inch  
**D:** 2,4 cm | 1 inch  
**H:** 28 cm | 11 inch  
**Weight:** 0,96 kg | 2.12 lb  
**Cable length (max):** 2,5 m | 99 inch

#### PACKAGING :

**L:** 46,7 cm | 18.4 inch  
**W:** 42,6 cm | 16.8 inch  
**H:** 6,8 cm | 2.7 inch  
**Weight:** 1,9 kg | 4.2 lb

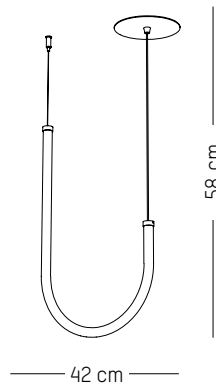

### Pendant lamp J

**L:** 42 cm | 16.5 inch  
**D:** 2,4 cm | 1 inch  
**H:** 58 cm | 22.8 inch  
**Weight:** 1,5 kg | 3.3 lb  
**Cable length (max):** 2,5 m | 99 inch

#### PACKAGING :

**L:** 62,5 cm | 24.6 inch  
**W:** 46,7 cm | 18.4 inch  
**H:** 6,8 cm | 2.7 inch  
**Weight:** 2,5 kg | 5.5 lb

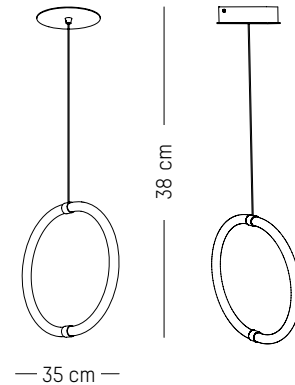

### Pendant lamp O

**L:** 35 cm | 14 inch  
**D:** 2,4 cm | 1 inch  
**H:** 38 cm | 17.8 inch  
**Weight:** 1,4 kg | 3.1 lb  
**Cable length (max):** 2,5 m | 99 inch

#### PACKAGING :

**L:** 46,7 cm | 18.4 inch  
**W:** 42,6 cm | 16.8 inch  
**H:** 6,8 cm | 2.7 inch  
**Weight:** 2,5 kg | 5.5 lb



**UNSEEN**

*STUDIO PEPE*

2020



FOR CONTRACT PROJECT WITH MINIMUM QUANTITY

### Ceiling plate for double pendant

-

#### MATERIALS

Smooth powder coated steel, varnished brass

#### COLOURS

Brass

#### ORIGIN

France

#### TECHNICAL SPECIFICATIONS

Ceiling plate sold separately to be combined with 2 different pendant lamps from UNSEEN collection

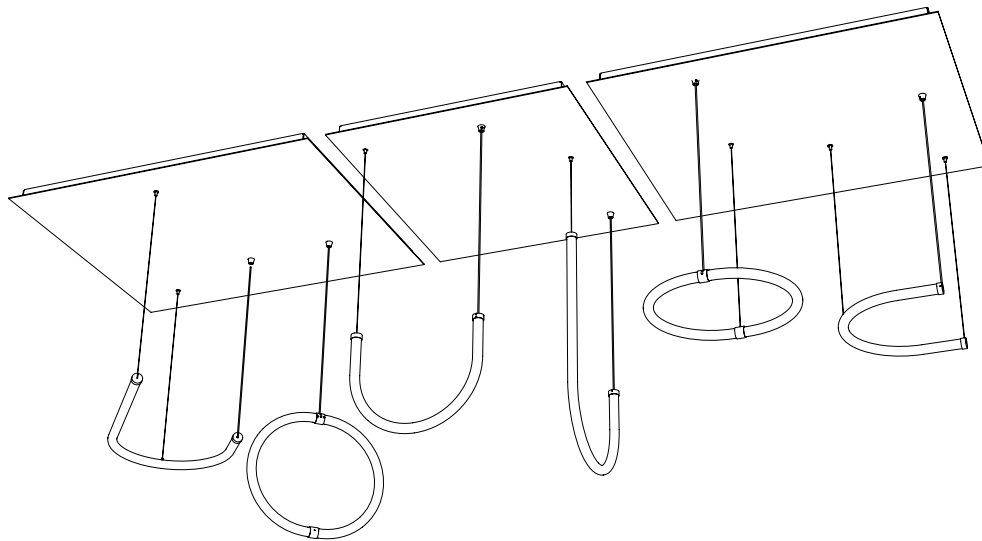

### Ceiling plate for double pendant JO

-

**L:** 89 cm | 35.1 inch  
**W:** 74 cm | 25.6 inch  
**H:** 4 cm | 1.4 inch  
**Weight:** 23 kg | 50.8 lb

#### PACKAGING :

**L:** 91 cm | 35.9 inch  
**W:** 76 cm | 26.4 inch  
**H:** 6 cm | 2.4 inch  
**Weight:** 26 kg | 57.4 lb

### Ceiling plate for double pendant UJ

-

**L:** 65 cm | 25.6 inch  
**W:** 74 cm | 25.6 inch  
**H:** 4 cm | 1.4 inch  
**Weight:** 17 kg | 37.5 lb

#### PACKAGING :

**L:** 67 cm | 26.4 inch  
**W:** 76 cm | 26.4 inch  
**H:** 6 cm | 2.4 inch  
**Weight:** 20 kg | 54.1 lb

### Ceiling plate for double pendant OU

-

**L:** 85 cm | 33.5 inch  
**W:** 74 cm | 25.6 inch  
**H:** 4 cm | 1.4 inch  
**Weight:** 23 kg | 50.8 lb

#### PACKAGING :

**L:** 87 cm | 34.3 inch  
**W:** 76 cm | 26.4 inch  
**H:** 6 cm | 2.4 inch  
**Weight:** 26 kg | 57.4 lb

**UNSEEN**

STUDIO PEPE

2020

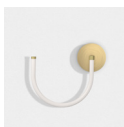

Wall lamp U

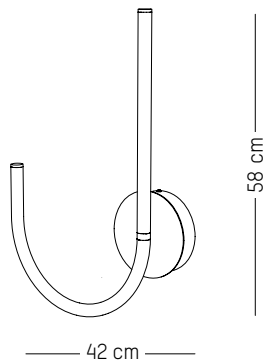

### Wall lamp J

**L:** 42 cm | 16.5 inch  
**D:** 7 cm | 2.8 inch  
**H:** 58 cm | 22.8 inch  
**Canopy:** Ø 15cm | 5.9 inch  
**Weight:** 1,5 kg | 3.3 lb

#### PACKAGING :

**L:** 62,5 cm | 24.6 inch  
**W:** 46,7 cm | 18.4 inch  
**H:** 7 cm | 2.8 inch  
**Weight:** 2,5 kg | 5.5 lb

FOR CONTRACT PROJECT WITH MINIMUM QUANTITY

### Wall lamps

-

#### MATERIALS

Smooth powder coated steel, varnished brass, polycarbonate tube

Lighting system: integrated LED

#### COLOURS

Brass and translucent

#### ORIGIN

France

#### TECHNICAL SPECIFICATIONS

##### LAMP J

**LED 12W** LED input: 1030 lumens

##### LAMP U

**LED 8.5W** LED input: 720 lumens



EUROPE

UK

US



Power

220-240 V 50-60HZ

Power

220-240 V 50-60 HZ

Power

110-120 V 60 HZ

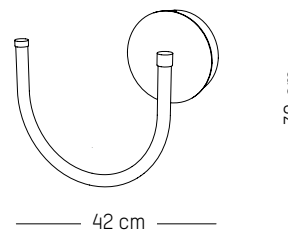

### Wall lamp U

-

**L:** 42 cm | 16.5 inch  
**D:** 7 cm | 2.8 inch  
**H:** 38 cm | 14.9 inch  
**Canopy:** Ø 15cm | 5.9 inch  
**Weight:** 0,96 kg | 2.12 lb

#### PACKAGING :

**L:** 46,7 cm | 18.4 inch  
**W:** 42,7 cm | 16.7 inch  
**H:** 7 cm | 2.8 inch  
**Weight:** 1,9 kg | 4.2 lb

# VERTIGO NOVA

## CONSTANCE GUISSET

2020



Black

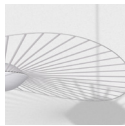

White

### Pendant lamps

-

#### MATERIALS

Lampshade: Fiberglass, steel with matte grained powder coating, polyurethane ribbons, Glass: Glass triplex  
Lighting system : integrated LED + painted aluminium  
Cable: mesh textile

#### COLORS

Black, White

#### ORIGIN

France

#### TECHNICAL SPECIFICATIONS



LED input:  
1350 lumens



EUROPE

UK

US



Power

220-240 V 50-60HZ

Power

220-240 V 50-60 HZ

Power

110-120 V 60 HZ

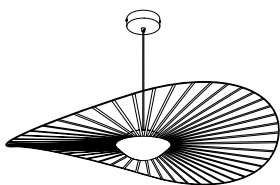

110 cm

#### Small

-

Ø: 110 cm | 43.3 inch  
H: 11,5 cm | 4.53 inch  
Weight: 2 kg | 4.4 lb  
Cable length: 250 cm | 99 inch or  
on demand: 1000 cm | 394 inch

#### PACKAGING :

L: 72 cm | 14.6 inch  
W: 72 cm | 14.6 inch  
H: 35 cm | 14.8 inch  
Weight: 3,5 | 7.7 lb

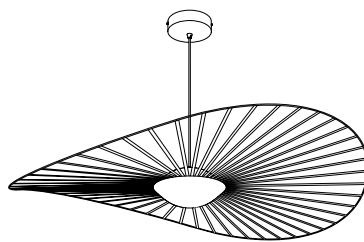

140 cm

#### Medium

-

Ø: 140 cm | 55.1 inch  
H: 12 cm | 4.7 inch  
Weight: 2,5 kg | 5.5 lb  
Cable length: 250 cm | 99 inch or  
on demand: 1000 cm | 394 inch

#### PACKAGING :

L: 72 cm | 14.6 inch  
W: 72 cm | 14.6 inch  
H: 35 cm | 14.8 inch  
Weight: 4 kg | 8.8 lb

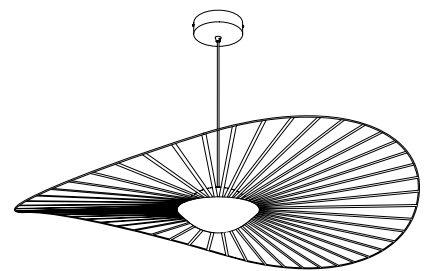

190 cm

#### Large

-

Ø: 190 cm | 74.8 inch  
H: 13,2 cm | 5.2 inch  
Weight: 3 kg | 6.8 lb  
Cable length: 250 cm | 99 inch or  
on demand: 1000 cm | 394 inch

#### PACKAGING :

L: 72 cm | 14.6 inch  
W: 72 cm | 14.6 inch  
H: 35 cm | 14.8 inch  
Weight: 5 kg | 11 lb

# VERTIGO NOVA

## CONSTANCE GUISSET

2020



Black

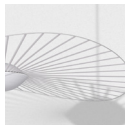

White

### Wall lamp

-

#### MATERIALS

**Lampshade:** Fiberglass, painted steel with matte grained powder coating, polyurethane ribbons  
**Glass:** Glass triplex, **Lighting system :** integrated LED  
**Cable:** plastic. Included cable for regular plug

#### COLORS

Black, White

#### ORIGIN

France

#### TECHNICAL SPECIFICATIONS



LED input:  
1350 lumens



EUROPE

UK

US



Power

220-240 V 50-60HZ

Power

220-240 V 50-60 HZ

Power

110-120 V 60 HZ

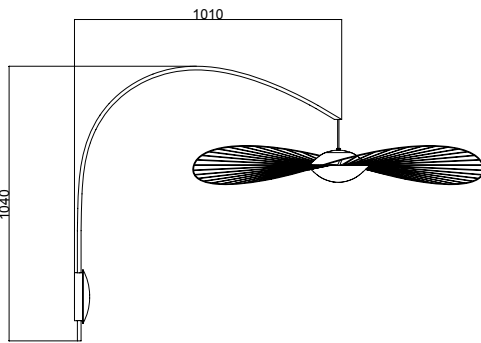

**Ø:** 110 cm | 43.3 inch  
**H:** 104 cm | 41 inch  
**Canopy:** Ø 15cm | 5.9 inch  
**Weight:** 3,2 kg | 7 lb

#### PACKAGING :

##### Carton box 1

**L:** 130 cm | 51.2 inch  
**W:** 61 cm | 24 inch  
**H:** 15,7 cm | 6.2 inch  
**Weight:** 5 kg | 11 lb

##### Carton box 2

**L:** 72 cm | 28.3 inch  
**W:** 72 cm | 28.3 inch  
**H:** 22 cm | 8.6 inch  
**Weight:** 2 kg | 4.4 lb

# VERTIGO NOVA

## CONSTANCE GUISET

2020



Black

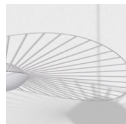

White

### Floor lamp

-

#### MATERIALS

Lampshade: Fiberglass, painted steel with matte grained powder coating, polyurethane ribbons

Glass: Glass triplex, Lighting system : integrated LED

Cable: mesh textile + With foot dimmer

#### COLORS

Black, White

#### ORIGIN

France

#### TECHNICAL SPECIFICATIONS



LED input:  
1350 lumens



EUROPE

UK

US



Power

220-240 V 50-60HZ

Power

220-240 V 50-60 HZ

Power

110-120 V 60 HZ

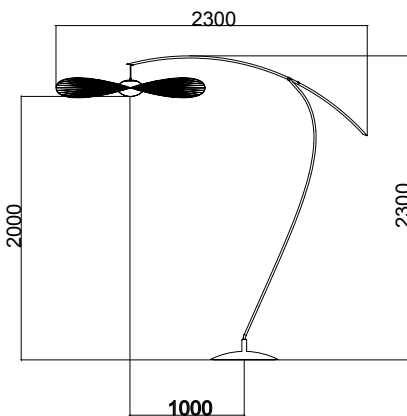

High position

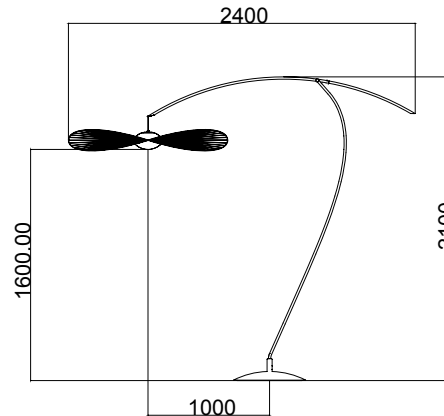

Low position

**L (max):** 240 cm | 95 inch  
**W:** 167 cm | 65.7 inch  
**Ø:** 110 cm | 43.3 inch  
**H (max):** 230 cm | 91 inch  
**Weight:** 20 kg | 44 lb

#### PACKAGING :

##### Carton box 1

**L:** 234 cm | 92.1 inch  
**W:** 51,7 cm | 20.3 inch  
**H:** 15,7 cm | 6.2 inch  
**Weight:** 25 kg | 55.1 lb

##### Carton box 2

**L:** 72 cm | 28.3 inch  
**W:** 72 cm | 28.3 inch  
**H:** 22 cm | 8.6 inch  
**Weight:** 2 kg | 4.4 lb

# MEDITERRANEA

## NOÉ DUCHAUFOUR-LAWRANCE

2016



Brushed brass

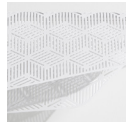

White\*



Black\*

### Pendant lamp

-

#### MATERIALS

Brushed or painted brass  
Lighting system: integrated LED

#### COLORS

Brushed brass, White, Black

#### ORIGIN

France

#### TECHNICAL SPECIFICATIONS

##### SMALL

LED 24V - 9W  
LED input: 936 lumens

##### LARGE

LED 24V - 1W  
LED input: 1620 lumens



EUROPE

UK



Power

220-240 V 50-60HZ

Power

220-240 V 50-60 HZ

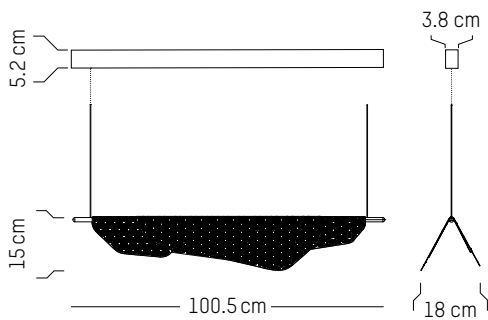

#### Small

-

L: 100,5 cm | 39.6 inch  
W: 18 cm | 7.1 inch  
H: 15 cm | 5.9 inch  
Cable length: 200 cm | 79 inch  
Weight: 4 kg | 8.8 lb

#### PACKAGING :

L: 109 cm | 42.9 inch  
W: 25 cm | 9.9 inch  
H: 30 cm | 11.8 inch  
Weight: 4,7 kg | 10.4 lb

\* While stocks last

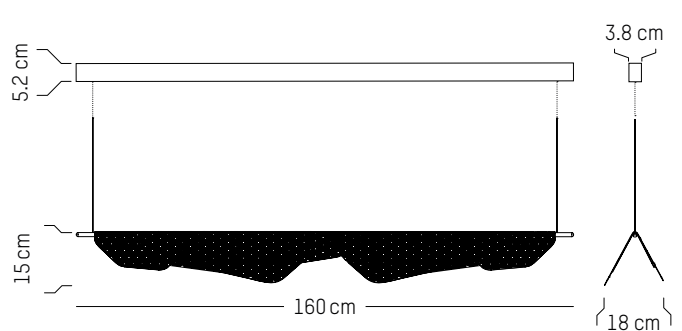

#### Large

-

L: 160 cm | 63 inch  
W: 18 cm | 7.1 inch  
H: 15 cm | 5.9 inch  
Cable length: 200 cm | 79 inch  
Weight: 6 kg | 13.2 lb

#### PACKAGING :

L: 167 cm | 65.7 inch  
W: 25 cm | 9.9 inch  
H: 30 cm | 11.8 inch  
Weight: 7 kg | 15.4 lb

# MEDITERRANEA

## NOÉ DUCHAUFOUR-LAWRANCE

2016



Brushed brass

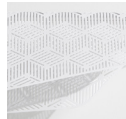

White\*



Black\*

### Pendant lamp

-

#### MATERIALS

Brushed or painted brass

Lighting system: integrated LED

#### COLORS

Brushed brass, White, Black

#### ORIGIN

France

#### TECHNICAL SPECIFICATIONS

##### SMALL

LED  
24V - 9W

LED input:  
936 lumens

##### LARGE

LED  
24V - 1W

LED input:  
1620 lumens



US



#### Power

110-120 V 60 HZ

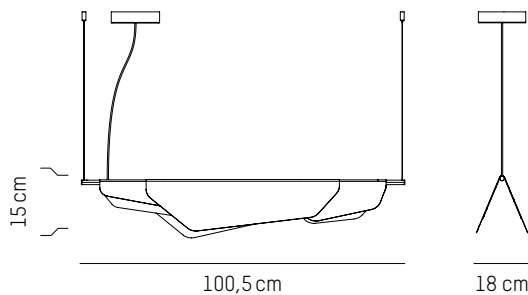

#### Small

L: 100,5 cm | 39.6 inch

W: 18 cm | 7.1 inch

H: 15 cm | 5.9 inch

Cable length: 200 cm | 79 inch

Weight: 4 kg | 8.8 lb

#### PACKAGING :

L: 109 cm | 42.9 inch

W: 25 cm | 9.9 inch

H: 30 cm | 11.8 inch

Weight: 4,7 kg | 10.4 lb

\* While stocks last

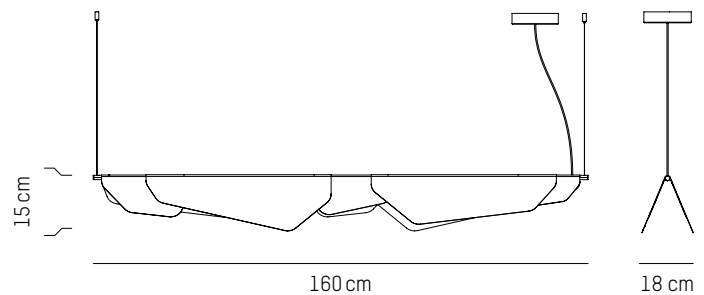

#### Large

L: 160 cm | 63 inch

W: 18 cm | 7.1 inch

H: 15 cm | 5.9 inch

Cable length: 200 cm | 79 inch

Weight: 6 kg | 13.2 lb

#### PACKAGING :

L: 167 cm | 65.7 inch

W: 25 cm | 9.9 inch

H: 30 cm | 11.8 inch

Weight: 7 kg | 15.4 lb

# MEDITERRANEA

## NOÉ DUCHAUFOUR-LAWRANCE

2016

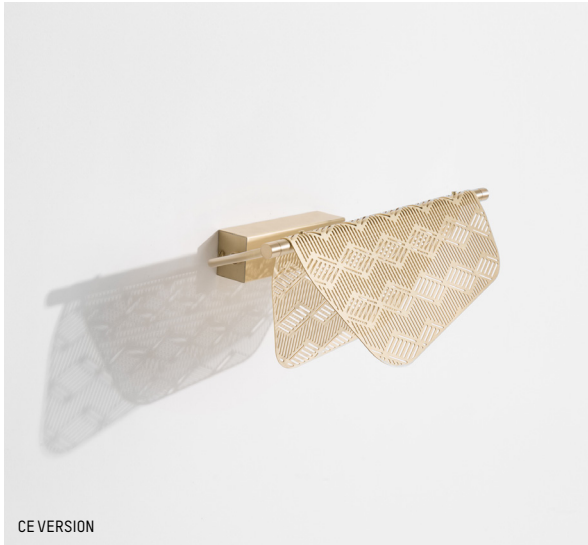

CE VERSION



Brushed brass

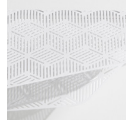

White\*



Black\*

### Wall lamp

-

#### MATERIALS

Brushed or painted brass  
Lighting system: integrated LED

#### COLORS

Brushed brass, White, Black

#### ORIGIN

France

#### TECHNICAL SPECIFICATIONS



LED input:  
324 lumens



EUROPE

UK



Power

220-240 V 50-60HZ

Power

220-240 V 50-60 HZ

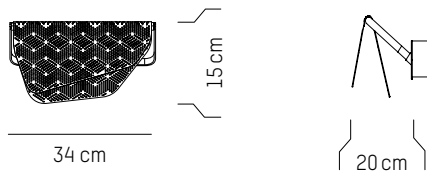

L: 34 cm | 13.4 inch  
D: 20 cm | 7.9 inch  
H: 15 cm | 5.9 inch  
Weight: 1 kg | 2.2 lb

#### PACKAGING :

Type: Carton box  
L: 42 cm | 16.5 inch  
W: 32 cm | 12.6 inch  
H: 24 cm | 9.5 inch  
Weight: 2,1 kg | 4.6 lb

\* While stocks last



# MEDITERRANEA

## NOÉ DUCHAUFOUR-LAWRANCE

2016

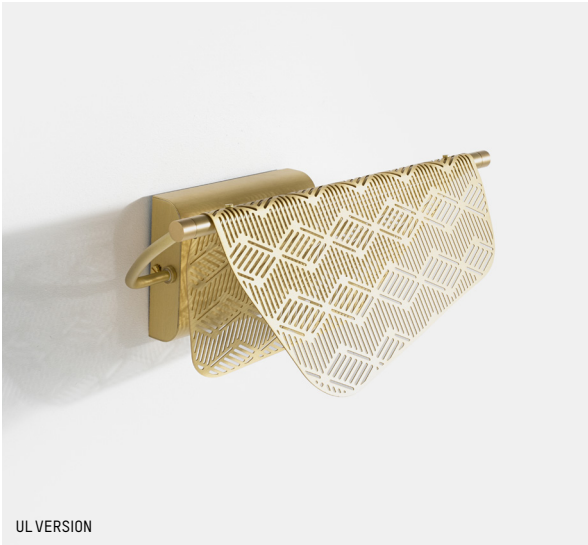

UL VERSION



Brushed brass



White\*



Black\*

### Wall lamp

-

#### MATERIALS

Brushed or painted brass

Lighting system: integrated LED

#### COLORS

Brushed brass, White, Black

#### ORIGIN

France

#### TECHNICAL SPECIFICATIONS



LED input:  
324 lumens



US



#### Power

110-120 V 60 HZ

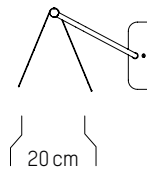
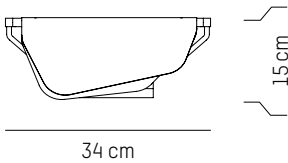

L: 34 cm | 13.4 inch  
D: 20 cm | 7.9 inch  
H: 15 cm | 5.9 inch  
Weight: 1 kg | 2.2 lb

#### PACKAGING :

Type: Carton box  
L: 42 cm | 16.5 inch  
W: 32 cm | 12.6 inch  
H: 24 cm | 9.5 inch  
Weight: 2,1 kg | 4.6 lb

\* While stocks last

# MEDITERRANEA

## NOÉ DUCHAUFOUR-LAWRANCE

2016



Brushed brass

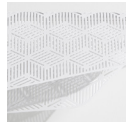

White\*



Black\*

### Table and Floor lamp

-

#### MATERIALS

Brushed or painted brass

Lighting system: integrated LED, Cable: plastic

#### COLORS

Brushed brass, White, Black

#### ORIGIN

France

#### TECHNICAL SPECIFICATIONS



LED input:  
312 lumens



EUROPE

UK

US



Power

220-240 V 50-60HZ

Power

220-240 V 50-60 HZ

Power

110-120 V 60 HZ

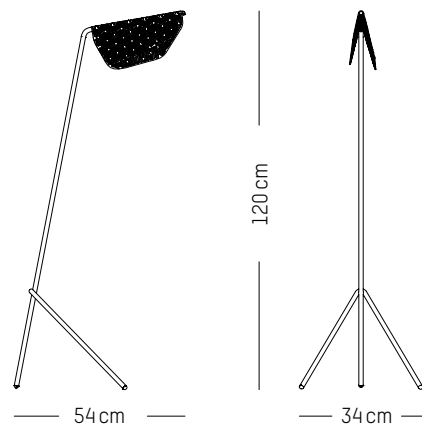
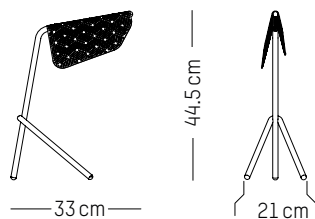

### Table lamp

L: 33 cm | 13 inch

W: 21 cm | 8.3 inch

H: 44,5 cm | 17.5 inch

Cable length: 200 cm | 79 inch

Weight: 1,3 kg | 2.9 lb

#### PACKAGING :

Type: Carton box

L: 46 cm | 18.1 inch

W: 45 cm | 17.7 inch

H: 23 cm | 9.1 inch

Weight: 2,7 kg | 6 lb

### Floor lamp

-

L: 54 cm | 21.3 inch

W : 34 cm | 13.4 inch

H : 120 cm | 47.3 inch

Cable length : 200 cm | 79 inch

Weight: 2 kg | 4.4 lb

#### PACKAGING :

Type: Carton box

L: 133 cm | 54.4 inch

W: 54 cm | 21.3 inch

H: 25 cm | 9.8 inch

Weight: 6,6 kg | 14.6 lb

\* While stocks last

**L I G H T I N G**



# GRILLO

ELISE FOUIN

2014



White



Green

## Wall lamp

-

### MATERIALS

Perforated disc : aluminium, grained matte epoxy paint  
Cable : textile

### COLORS

White  
Cable colors : White, Green

### ORIGIN

France

### TECHNICAL SPECIFICATIONS



Power

220-240 V 50-60HZ

Power

220-240 V 50-60 HZ

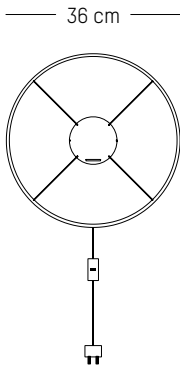

## Grillo L

-

Ø: 36 cm | 14.2 inch

D: 10 cm | 3.9 inch

Cable length: 300 cm | 118 inch

Weight: 0,6 kg | 1.3 lb

### PACKAGING :

Type: Carton box

L: 42 cm | 16.5 inch

W: 42 cm | 16.5 inch

H: 15 cm | 5.9 inch

Weight: 1,5 kg | 3.3 lb

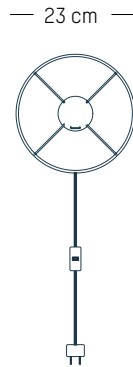

## Grillo S

-

Ø: 23 cm | 9.1 inch

D: 10 cm | 3.9 inch

Cable length: 300 cm | 118 inch

Weight: 0,3 kg | 0.7 lb

### PACKAGING :

Type: Carton box

L: 28 cm | 11 inch

W: 28 cm | 11 inch

H: 15 cm | 5.9 inch

Weight: 0,9 kg | 2 lb

# LANTERNA

SAM BARON

2014



Black



White

## Pendant lamp

-

### MATERIALS

Structure: lacquered steel  
Lampshade and cable: fabrics  
Socket and ceiling cup: PVC

### COLORS

Black, White

### ORIGIN

Europe

### TECHNICAL SPECIFICATIONS



EUROPE

UK

US



Power

220-240 V 50-60HZ

Power

220-240 V 50-60 HZ

Power

110-120 V 60 HZ

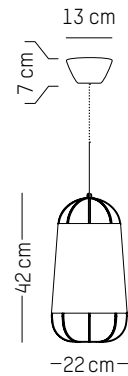

### Small

-

Ø: 22 cm | 8.7 inch  
H: 42 cm | 16.5 inch  
Weight: 0,4 kg | 0.9 lb  
Cable length: 250 cm | 99 inch or  
on demand: 1000 cm | 394 inch

#### PACKAGING :

Type: Carton box  
L: 27,5 cm | 10.8 inch  
W: 27,5 cm | 10.8 inch  
H: 48,5 cm | 19.1 inch  
Weight: 1,3 kg | 2.9 lb

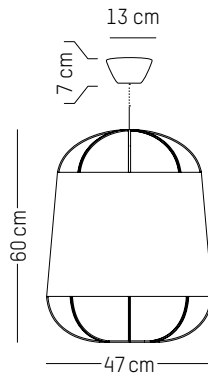

### Medium

-

Ø: 47 cm | 18.5 inch  
H: 60 cm | 23.6 inch  
Weight: 0,8 kg | 1.8 lb  
Cable length: 250 cm | 99 inch or  
on demand: 1000 cm | 394 inch

#### PACKAGING :

Type: Carton box  
L: 52,5 cm | 20.7 inch  
W: 52,5 cm | 20.7 inch  
H: 66,5 cm | 26.2 inch  
Weight: 3,5 kg | 7.7 lb

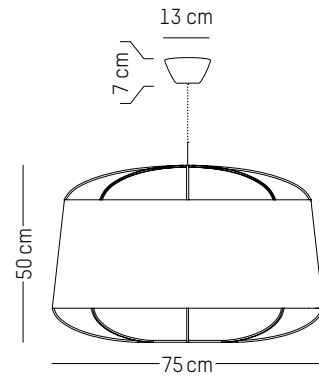

### Large

-

Ø: 75 cm | 30 inch  
H: 50 cm | 20 inch  
Weight: 1,2 kg | 2.7 lb  
Cable length: 250 cm | 99 inch or  
on demand: 1000 cm | 394 inch

#### PACKAGING :

Type: Carton box  
L: 81 cm | 31.9 inch  
W: 58,1 cm | 31.9 inch  
H: 55,5 cm | 21.9 inch  
Weight: 6,8 kg | 15 lb

# SO - SAGE

SAM BARON

2016



## Pendant lamp

### MATERIALS

Pendant: Borosilicate glass; Cable: textile  
Ceiling rose : brass graphite finish, steel

### COLORS

Clear-transparent

### ORIGIN

France

### TECHNICAL SPECIFICATIONS

Compatible transformer for variation with trailing edge phase control



Halogen

EUROPE

UK



Power

220-240 V 50-60HZ

Power

220-240 V 50-60 HZ

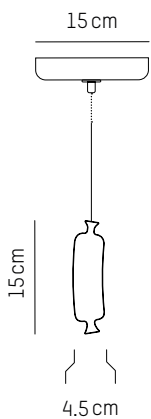

### Diot

Ø: 4,2 cm | 1.7 inch  
H: 15 cm | 5.1 inch  
Cable: 175 cm | 69 in  
Weight: 0,5 kg | 1.1 lb

#### PACKAGING :

L: 49 cm | 19.3 inch  
W: 20 cm | 7.9 inch  
H: 18 cm | 7.1 inch  
Weight: 1,1 kg | 2.4 lb

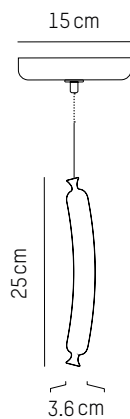

### Strasbourg

Ø: 3,6 cm | 1.4 inch  
H: 25 cm | 9.8 inch  
Cable: 175 cm | 69 in  
Weight: 0,6 kg | 1.3 lb

#### PACKAGING :

L: 49 cm | 19.3 inch  
W: 20 cm | 7.9 inch  
H: 18 cm | 7.1 inch  
Weight: 1,1 kg | 2.4 lb

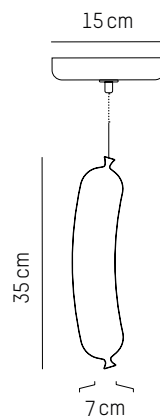

### Morteau

Ø: 7 cm | 2.8 inch  
H: 35 cm | 13.8 inch  
Cable: 175 cm | 69 in  
Weight: 0,9 kg | 2 lb

#### PACKAGING :

L: 49 cm | 19.3 inch  
W: 20 cm | 7.9 inch  
H: 18 cm | 7.1 inch  
Weight: 1,1 kg | 2.4 lb

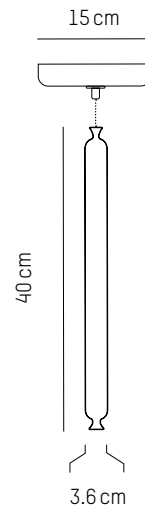

### Gendarme

Ø: 3,6 cm | 1.4 inch  
H: 40 cm | 15.9 inch  
Cable: 175 cm | 69 in  
Weight: 0,6 kg | 1.3 lb

#### PACKAGING :

L: 49 cm | 19.3 inch  
W: 20 cm | 7.9 inch  
H: 18 cm | 7.1 inch  
Weight: 1,1 kg | 2.4 lb

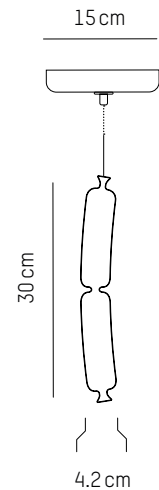

### Toulouse

Ø: 4,2 cm | 1.7 inch  
H: 30 cm | 11.8 inch  
Cable: 175 cm | 69 in  
Weight: 0,6 kg | 1.3 lb

#### PACKAGING :

L: 49 cm | 19.3 inch  
W: 20 cm | 7.9 inch  
H: 18 cm | 7.1 inch  
Weight: 1,1 kg | 2.4 lb

**SO - SAGE**

*SAM BARON*

2016



## Pendant lamp

-

### MATERIALS

Pendant: Borosilicate glass; Cable: textile  
Ceiling rose : brass graphite finish, steel

### COLORS

Clear-transparent

### ORIGIN

France

### TECHNICAL SPECIFICATIONS

Compatible transformer for variation with trailing edge phase control



Halogen

EUROPE

UK



Power

220-240 V 50-60HZ

Power

220-240 V 50-60 HZ

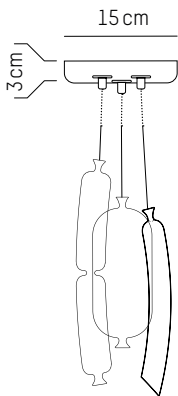

### Set of 3 #1

-

Ø: 15 cm | 5.9 inch  
H: 33 cm | 13 inch  
Cable length: 175 cm | 69 inch  
Weight: 1 kg | 2.2 lb

#### PACKAGING :

L: 49 cm | 19.3 inch  
W: 32 cm | 12.6 inch  
H: 12 cm | 4.7 inch  
Weight: 1,9 kg | 4.2 lb

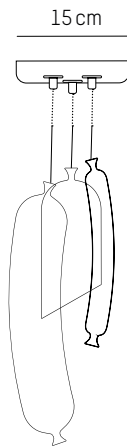

### Set of 3 #2

-

Ø: 4,2 cm | 1.7 inch  
H: 38 cm | 15 inch  
Cable length: 175 cm | 69 inch  
Weight: 1,2 kg | 2.7 lb

#### PACKAGING :

L: 49 cm | 19.3 inch  
W: 32 cm | 12.6 inch  
H: 12 cm | 4.7 inch  
Weight: 1,9 kg | 4.2 lb

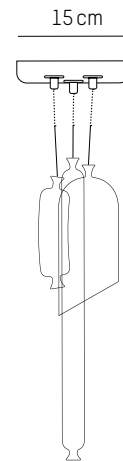

### Set of 3 #3

-

Ø: 4,2 cm | 1.7 inch  
H: 45 cm | 16.9 inch  
Cable length: 175 cm | 69 inch  
Weight: 1 kg | 2.2 lb

#### PACKAGING :

L: 49 cm | 19.3 inch  
W: 32 cm | 12.6 inch  
H: 12 cm | 4.7 inch  
Weight: 1,9 kg | 4.2 lb



**SO - SAGE**

*SAM BARON*

2016



## Pendant lamp

-

### MATERIALS

Pendant: Borosilicate glass; Cable: textile  
Ceiling rose : brass graphite finish, steel

### COLORS

Clear-transparent

### ORIGIN

France

### TECHNICAL SPECIFICATIONS

Compatible transformer for variation with trailing edge phase control



Halogen

EUROPE

UK



Power

220-240 V 50-60HZ

Power

220-240 V 50-60 HZ

35

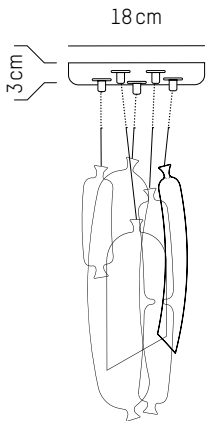

## Set of 5

-

**Ø:** 18 cm | 7.1 inch  
**H:** 38 cm | 15 inch  
**Cable length :** 175 cm | 69 inch  
**Weight:** 1,2 kg | 2.7 lb

### PACKAGING :

**L:** 50 cm | 19.7 inch  
**W:** 45 cm | 17.7 inch  
**H:** 12 cm | 4.7 inch  
**Weight:** 1,9 kg | 4.2 lb

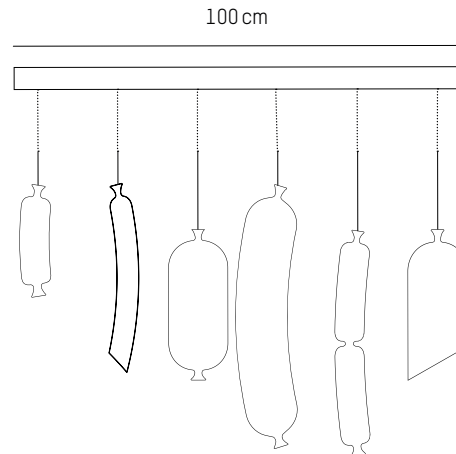

## Line of 6

-

**L:** 100 cm | 39.4 inch  
**Cable length :** 175 cm | 69 inch  
**Weight:** 2,8 kg | 6.2 lb

### PACKAGING :

**L:** 10 cm | 3.9 inch  
**W:** 30 cm | 11.8 inch  
**H:** 11 cm | 4.3 inch  
**Weight:** 4,3 kg | 9.5 lb

# TIDELIGHT

PIERRE FAVRESSE

2012



## Table Lamp

-

### MATERIALS

Lampshade : Blown glass; Base : cork

### COLORS

Clear-transparent, smoked

### ORIGIN

France

### TECHNICAL SPECIFICATIONS



Power

220-240 V 50-60HZ

Power

220-240 V 50-60 HZ

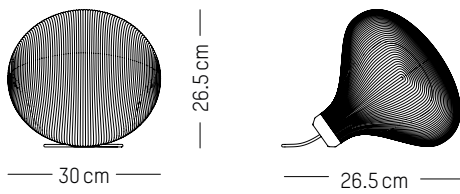

**Ø:** 30 cm | 11.8 inch  
**W:** 26,5 cm | 10.4 inch  
**H:** 26,5 cm | 10.4 inch  
**Cable length :** 180 cm | 70.8 inch  
**Weight:** 2 kg | 4.4 lb

### PACKAGING :

**W:** 37 cm | 14.6 inch  
**H:** 37,5 cm | 14.8 inch  
**Weight:** 2,7 kg | 6 lb

# VERTIGO

## CONSTANCE GUISET

2010



Black



Green



Copper



White



Cobalt



Beetle

### Pendant lamps

-

#### MATERIALS

Pendant: Fiberglass, lacquered steel, polyurethane ribbons

Cable: mesh textile; Ceiling rose and socket: plastic

#### COLORS

Black, Green, Copper, White, Cobalt, Beetle

#### ORIGIN

France

#### TECHNICAL SPECIFICATIONS



EUROPE

UK

US



Power

220-240 V 50-60HZ

Power

220-240 V 50-60 HZ

Power

110-120 V 60 HZ

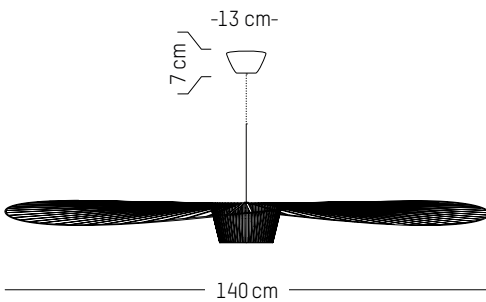

### Small

-

Ø: 140 cm | 55 inch

Weight: 0,5 kg | 1 lb

Cable length: 250 cm | 99 inch or  
on demand: 1000 cm | 394 inch

#### PACKAGING :

Type: Carton box

L: 72,5 cm | 28.5 inch

W: 72,5 cm | 28.5 inch

H: 21 cm | 8 inch

Weight: 2,28 | 5 lb

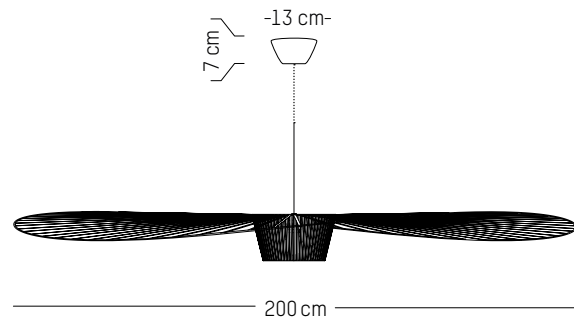

### Large

-

Ø: 200 cm | 79 inch

Weight: 0,5 kg | 1 lb

Cable length: 250 cm | 99 inch or  
on demand: 1000 cm | 394 inch

#### PACKAGING :

Type: Carton box

L: 72,5 cm | 28.5 inch

W: 72,5 cm | 28.5 inch

H: 21 cm | 8 inch

Weight: 2,28 | 5 lb

**FURNITURE**







# FRANCIS

CONSTANCE GUISET

2011



Black & Blue-purple watercolor



Black & Pink watercolor

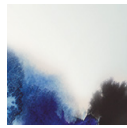

Black & Blue watercolor



White & Green watercolor

S, L

XL

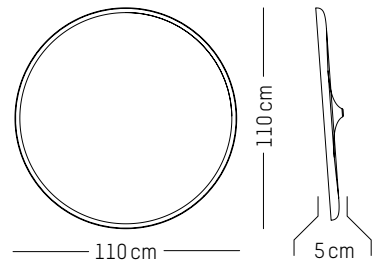
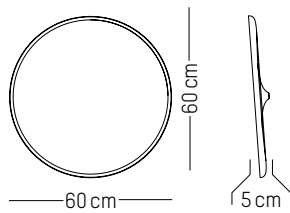
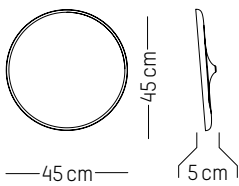

## Small

Ø: 45 cm | 17.7 inch  
D: 5 cm | 2 inch  
Weight: 3.5 kg | 7.7 lb

### PACKAGING :

Type: Carton box  
L: 52 cm | 20.5 inch  
W: 52 cm | 20.5 inch  
H: 11 cm | 4.3 inch  
Weight: 3 kg | 6.6 lb

## Large

Ø: 60 cm | 26.6 inch  
D: 5 cm | 2 inch  
Weight: 7 kg | 15.4 lb

### PACKAGING :

Type: Carton box  
L: 68 cm | 26.7 inch  
W: 68 cm | 26.7 inch  
H: 11 cm | 4.3 inch  
Weight: 8,8 kg | 19.4 lb

## Extra large

Ø: 110 cm | 43.3 inch  
D: 5,5 cm | 2.2 inch  
Weight: 23 kg | 50.7 lb

### PACKAGING :

Type: Carton box  
L: 118 cm | 46.5 inch  
W: 118 cm | 46.5 inch  
H: 9,5 cm | 3.7 inch  
Weight: 28 kg | 11 lb

# FRANCIS

## CONSTANCE GUISET

2018



### Coffee tables

-

#### MATERIALS

Mirror  
Mirror shell and table leg: Steel with matte grained powder coating

#### COLORS

Black and blue watercolor, White and green watercolor

#### ORIGIN

France



Black & Blue watercolor



White & Green watercolor

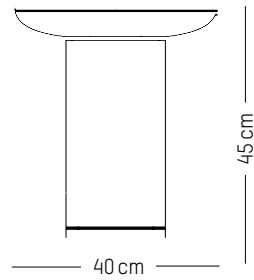

#### Small

-

**D:** 40 cm | 15.7 inch  
**H:** 45 cm | 17.5 lb  
**Weight:** 8 kg | 17.6 lb

#### PACKAGING :

**Type:** Carton box  
**L:** 52 cm | 20.5 inch  
**W:** 52 cm | 20.5 inch  
**H:** 50 cm | 19.7 inch  
**Weight:** 10 kg | 22 lb

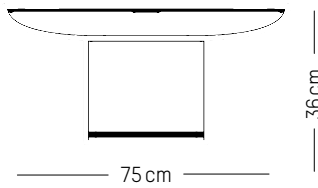

#### Large

-

**D:** 75 cm | 29.5 inch  
**H:** 36 cm | 14.2 inch  
**Weight:** 19 kg | 41.9 lb

#### PACKAGING :

**Type:** Carton box  
**L:** 86 cm | 33.9 inch  
**W:** 86 cm | 33.9 inch  
**H:** 39 cm | 15.3 inch  
**Weight:** 24 kg | 9.5 lb

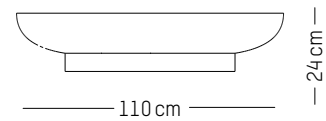

#### Extra large

-

**D:** 110 cm | 43.3 inch  
**H:** 24 cm | 9.4 inch  
**Weight:** 45 kg | 99.2 lb

#### PACKAGING :

**Type:** Carton box  
**L:** 118 cm | 46.5 inch  
**W:** 118 cm | 46.5 inch  
**H:** 28 cm | 11.2 inch  
**Weight:** 53 kg | 20.9 lb

# FROMME

## TOM CHUNG

2019



Black



Brown-red



Mint-green



Blue



Coral

### Chair

-

#### MATERIALS

Aluminium, matte grained Anti UV powder coating for outdoor use

#### COLORS

Black, Brown-red, Mint-green, Blue, Coral

#### ORIGIN

China

#### TECHNICAL SPECIFICATIONS

Compliant with EN 581-1 ; EN581-2 for Contract use

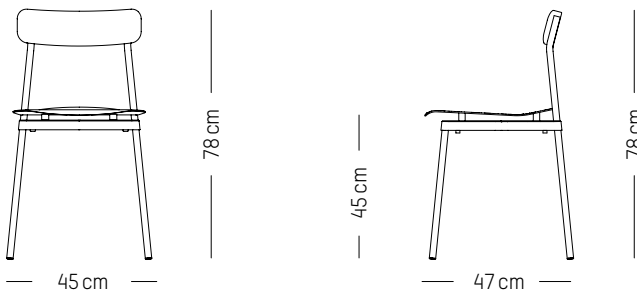

### Chair

-

**L:** 45 cm | 18.5 inch

**D:** 47 cm | 18.5 inch

**H:** 78 cm | 30.7 inch

**H (seat):** 45 cm | 18.5 inch

**Weight:** 3,3 kg | 7.3 lb

#### PACKAGING (X2) :

**L:** 49 cm | 19.3 inch

**W:** 49 cm | 19.3 inch

**H:** 79 cm | 31.1 inch

**Weight:** 9,6 kg | 21.2 lb



**FROMME**

*TOM CHUNG*

2021



Black



Brown-red



Mint-green



Blue



Coral

## Lounge armchair

-

### MATERIALS

Aluminium, matte grained Anti UV powder coating for outdoor use

### COLORS

Black, Brown-red, Mint-green, Blue, Coral

### ORIGIN

China

### TECHNICAL SPECIFICATIONS

Compliant with EN 581-1 ; EN581-2 for Contract use

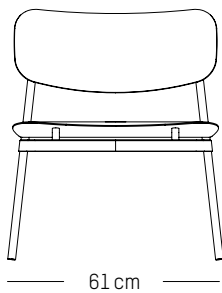

61 cm

71 cm

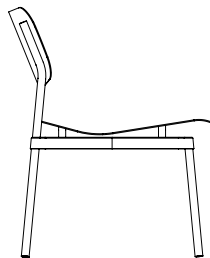

58 cm

40 cm

## Lounge armchair

-

**L:** 61 cm | 24 inch

**D:** 58 cm | 23 inch

**H:** 71 cm | 28 inch

**H (seat):** 40 cm | 16 inch

**Weight:** 5,9 kg | 13 lb

### PACKAGING :

**L:** 64 cm | 25.2 inch

**W:** 59 cm | 23.2 inch

**H:** 71 cm | 28 inch

**Weight:** 8 kg | 17.6 lb

# FROMME

## TOM CHUNG

2021



Black



Brown-red



Mint-green



Blue



Coral

### Stool

-

#### MATERIALS

Aluminium, matte grained Anti UV powder coating for outdoor use

#### COLORS

Black, Brown-red, Mint-green, Blue, Coral

#### ORIGIN

China

#### TECHNICAL SPECIFICATIONS

Compliant with EN 581-1 ; EN581-2 for Contract use

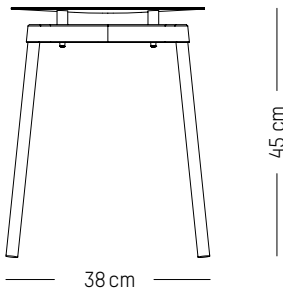

### Stool

-

**L:** 38cm | 15 inch

**D:** 38 cm | 15 inch

**H:** 45 cm | 18 inch

**Weight:** 2,6 kg | 5.7 lb

#### PACKAGING (X2):

**L:** 40 cm | 16 inch

**W:** 40 cm | 16 inch

**H:** 55 cm | 21.6 inch

**Weight:** 7 kg | 15.4 lb

# FROMME

## TOM CHUNG

2021



Black



Brown-red



Mint-green



Blue



Coral

### High Stools

-

#### MATERIALS

Aluminium, matte grained Anti UV powder coating for outdoor use

#### COLORS

Black, Brown-red, Mint-green, Blue, Coral

#### ORIGIN

China

#### TECHNICAL SPECIFICATIONS

Compliant with EN 581-1 ; EN581-2 for Contract use

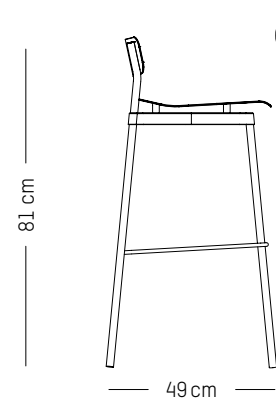
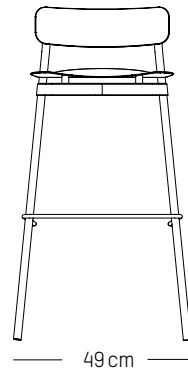
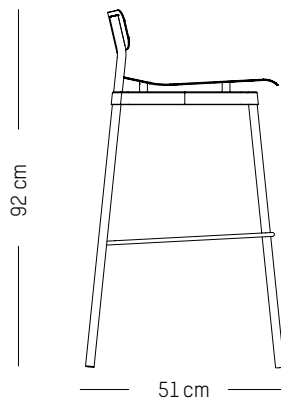
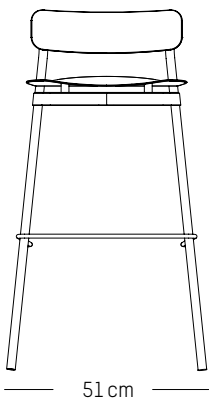

### High stool

-

**L:** 51cm | 20 inch

**D:** 51 cm | 20 inch

**H:** 92 cm | 36 inch

**H (seat):** 75 cm | 29.5 inch

**Weight:** 4,5 kg | 9.9 lb

#### PACKAGING :

**L:** 53 cm | 20.87 inch

**W:** 53 cm | 20.87 inch

**H:** 93 cm | 36. inch

**Weight:** 6,5 kg | 14.3 lb

### High stool

-

**L:** 49cm | 19.3 inch

**D:** 49 cm | 19.3 inch

**H:** 81 cm | 31.9 inch

**H (seat):** 65 cm | 25.6 inch

**Weight:** 4,1 kg | 9.1 lb

#### PACKAGING :

**L:** 53 cm | 20.9 inch

**W:** 53 cm | 20.9 inch

**H:** 83 cm | 32.7 inch

**Weight :** 4.1 kg | 9.1 lb

**FROMME**

*TOM CHUNG*

2021



### Square table

-

#### MATERIALS

Aluminium, matte grained Anti UV powder coating for outdoor use

#### COLORS

Black, Brown-red, Mint-green, Blue, Coral

#### ORIGIN

China

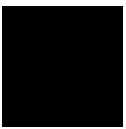

Black



Brown-red



Mint-green



Blue



Coral

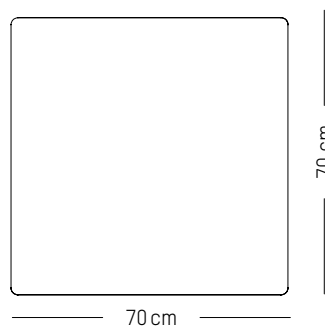
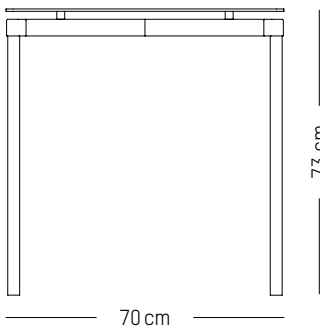

### Square table

-

**L:** 70cm | 28 inch

**D:** 70 cm | 28 inch

**H:** 73 cm | 29 inch

**Weight:** 14,5 kg | 32 lb

#### PACKAGING :

**L:** 90 cm | 35.4 inch

**W:** 72 cm | 28.4 inch

**H:** 8 cm | 3.2 inch

**Weight:** 18 kg | 39.7 lb

**FROMME**

*TOM CHUNG*

2021



Black



Brown-red



Mint-green



Blue



Coral

## Rectangular table

-

### MATERIALS

Aluminium, matte grained Anti UV powder coating for outdoor use

### COLORS

Black, Brown-red, Mint-green, Blue, Coral

### ORIGIN

China

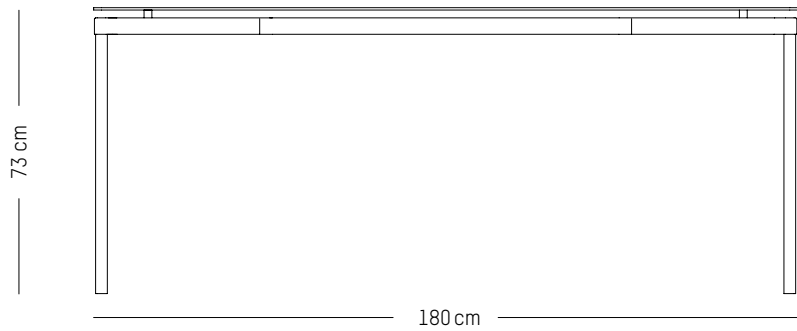
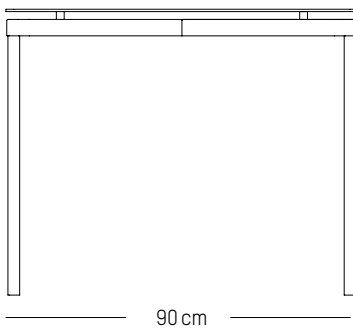

## Rectangular table

-

**L:** 180cm | 70.9 inch

**W:** 90 cm | 35.4 inch

**H:** 73 cm | 29 inch

**Weight:** 37,5 kg | 82.7 lb

### PACKAGING :

**L:** 200 cm | 78.7 inch

**W:** 92 cm | 36.2 inch

**H:** 8 cm | 3.2 inch

**Weight:** 44 kg | 97 lb

**FROMME**

*TOM CHUNG*

2022



**Coffee table**

-

**MATERIALS**

Aluminium, matte grained Anti UV powder coating for outdoor use

**COLORS**

Black, Brown-red, Mint-green, Blue, Coral

**ORIGIN**

China



Black



Brown-red



Mint-green



Blue



Coral

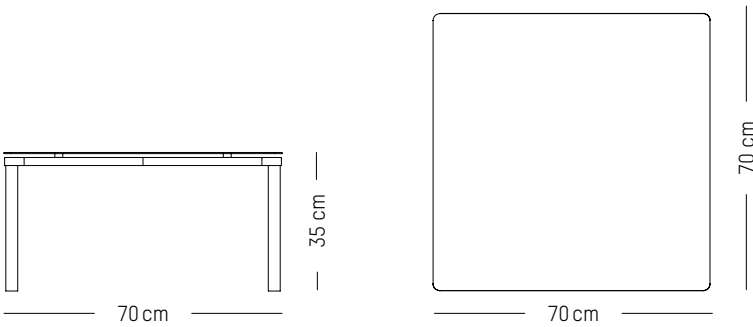

**Coffee table**

-

**L:** 70cm | 28 inch

**W:** 70 cm | 28 inch

**H:** 35 cm | 13.8 inch

**Weight:** 12 kg | 26.5 lb

**PACKAGING :**

**L:** 88 cm | 34.7 inch

**W:** 77 cm | 30.3 inch

**H:** 20 cm | 7.9 inch

**Weight:** 16 kg | 35.3 lb

# FROMME SOFT

## TOM CHUNG

2020

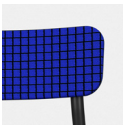

Blue-black



Black-blue

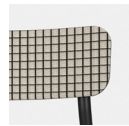

Ecru-black



Black-ecru

### Chair

-

#### MATERIALS

Chair : Aluminium with grained powder coating  
PU foam, cover (removable and reversible) polyester knit

#### COLORS

Black and Black-blue upholstery, Black-blue and black upholstery, Black and ecru-black upholstery, Ecru-black and black upholstery

#### ORIGIN

China and Europe

Compliant with EN 581-1 ; EN581-2 for Contract use  
Removable and reversible knitted cover; Machine washable (40°)  
Compliant with EN1021-1 et 1021-2 for Fire resistance

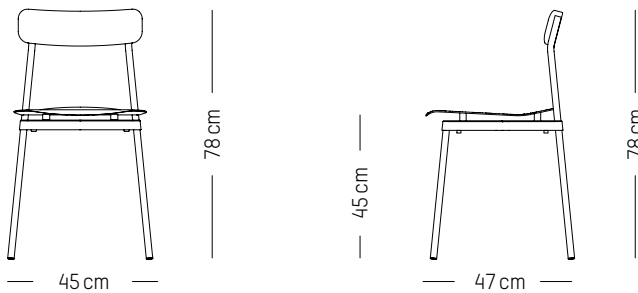

### Chair

-

**L:** 45 cm | 18.5 inch  
**D:** 47 cm | 18.5 inch  
**H:** 78 cm | 30.7 inch  
**H (seat):** 45 cm | 18.5 inch  
**Weight:** 4,8 kg | 10.6 lb

#### PACKAGING :

**L:** 50 cm | 19.7 inch  
**W:** 47 cm | 18.5 inch  
**H:** 79 cm | 31.1 inch  
**Weight:** 7 kg | 15.4 lb

# FROMME SOFT

## TOM CHUNG

2021

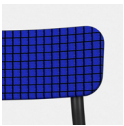

Blue-black



Black-blue

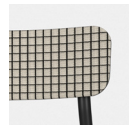

Ecru-black



Black-ecru

### Lounge armchair

#### MATERIALS

Chair : Aluminium with grained powder coating  
PU foam, cover (removable and reversible) polyester knit

#### COLORS

Black and Black-blue upholstery, Black-blue and black upholstery, Black and ecru-black upholstery, Ecru-black and black upholstery

#### ORIGIN

China and Europe

Compliant with EN 581-1 ; EN581-2 for Contract use  
Removable and reversible knitted cover; Machine washable (40°)  
Compliant with EN1021-1 et 1021-2 for Fire resistance

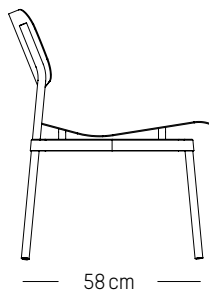
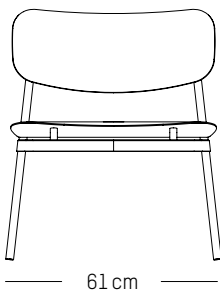

### Lounge armchair

**L:** 61cm | 24 inch  
**D:** 58 cm | 23 inch  
**H:** 71 cm | 28 inch  
**H (seat):** 40 cm | 16 inch  
**Weight:** 7,9 kg | 17.4 lb

#### PACKAGING :

**L:** 64 cm | 25.2 inch  
**W:** 59 cm | 23.2 inch  
**H:** 71 cm | 28 inch  
**Weight:** 11 kg | 24.3 lb



# FROMME SOFT

## TOM CHUNG

2020



Blue-black



Black-blue

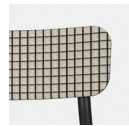

Ecru-black



Black-ecru

### High Stools

-

#### MATERIALS

Chair : Aluminium with grained powder coating  
PU foam, cover (removable and reversible) polyester knit

#### COLORS

Black and Black-blue upholstery, Black-blue and black upholstery, Black and ecru-black upholstery, Ecru-black and black upholstery

#### ORIGIN

China and Europe

Compliant with EN 581-1 ; EN581-2 for Contract use  
Removable and reversible knitted cover; Machine washable (40°)  
Compliant with EN1021-1 et 1021-2 for Fire resistance

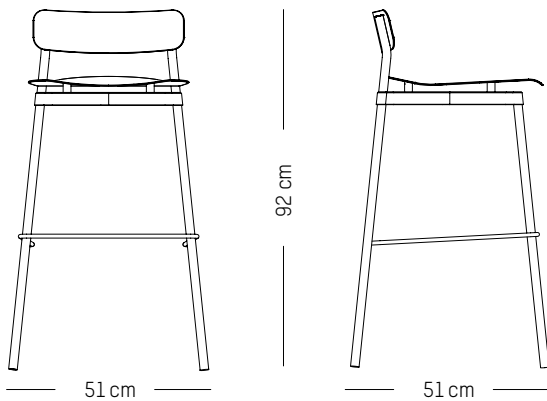

### High stool

-

**L:** 51cm | 20.4 inch  
**D:** 51 cm | 20.1 inch  
**H:** 92 cm | 36.2 inch  
**H (seat):** 75 cm | 29.5 inch  
**Weight:** 6 kg | 13.2 lb

#### PACKAGING :

**L:** 53 cm | 20.87 inch  
**W:** 53 cm | 20.87 inch  
**H:** 93 cm | 36.6 inch  
**Weight:** 10 kg | 22 lb

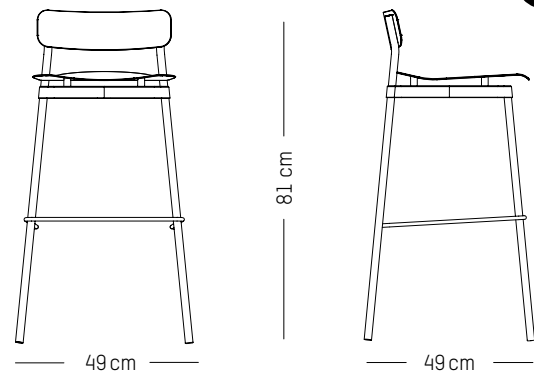

### High stool

-

**L:** 49cm | 19.3 inch  
**D:** 49 cm | 19.3 inch  
**H:** 81 cm | 31.9 inch  
**H (seat):** 65 cm | 25.6 inch  
**Weight:** 4,1 kg | 9.1 lb

#### PACKAGING :

**L:** 53 cm | 20.9 inch  
**W:** 53 cm | 20.9 inch  
**H:** 83 cm | 32.7 inch  
**Weight:** 4.1 kg | 9.1 lb

NEW

**HOLLO**

AC/AL STUDIO

2012



Black



Anthracite



Gold

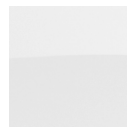

White



Burgundy



Blue

## Stool and tables

-

### MATERIALS

Steel with matte grained powder coating

### COLORS

Black, Anthracite, Gold, White, Burgundy, Blue

### ORIGIN

Europe

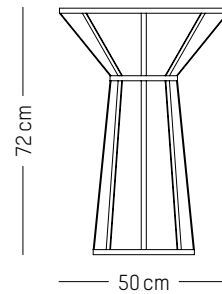
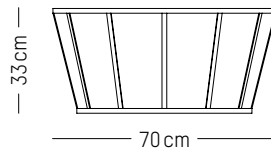
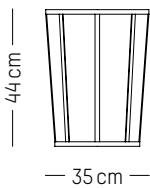

## Stool

-

**Ø:** 35 cm | 14 inch  
**H:** 44 cm | 17.3 inch  
**Weight:** 4 kg | 8.8 lb

### PACKAGING :

**Type:** Carton box  
**L:** 41,5 cm | 16.3 inch  
**W:** 41 cm | 16.1 inch  
**H:** 52 cm | 20.5 inch  
**Weight:** 5,6 kg | 12.3 lb

## Coffee table

-

**Ø:** 70 cm | 27.6 inch  
**H:** 33 cm | 13 inch  
**Weight:** 12 kg | 2.2 lb

### PACKAGING :

**Type:** Carton box  
**L:** 76 cm | 29.9 inch  
**W:** 74,5 cm | 29.3 inch  
**H:** 40 cm | 15.8 inch  
**Weight:** 15,3 kg | 33.7 lb

## Bistro table

-

**Ø:** 50 cm | 28.4 inch  
**H:** 72 cm | 19.7 inch  
**Weight:** 7 kg | 15.4 lb

### PACKAGING :

**Type:** Carton box  
**L:** 56 cm | 22.1 inch  
**W:** 56 cm | 22.1 inch  
**H:** 78 cm | 30.7 inch  
**Weight:** 11,1 kg | 24.5 lb

**ISO**

*STUDIO POOL*

2014



Black



White



Burgundy



Blue

**Side tables**

-

**MATERIALS**

Steel with matte grained powder coating

**COLORS**

Black, White, Burgundy, Blue

**ORIGIN**

Europe

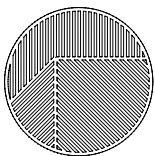

Ø 47 cm

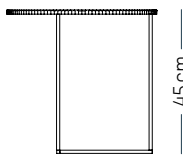

— 47 cm —

45 cm

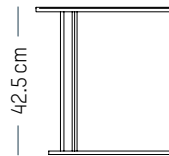

42,5 cm

— 40 cm —

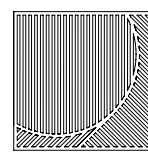

— 40 cm —

40 cm

**ISO-A**

-

**Ø:** 47 cm | 18.5 inch  
**H:** 45 cm | 17.7 inch  
**Weight:** 5 kg | 11 lb

**PACKAGING :**

**Type:** Carton box  
**L:** 52 cm | 20.5 inch  
**W:** 51 cm | 20.1 inch  
**H:** 50 cm | 19.7 inch  
**Weight:** 7,8 kg | 17.2 lb

**ISO-B**

-

**L:** 40 cm | 15.8 inch  
**W:** 40 cm | 15.8 inch  
**H:** 42,5 cm | 16.7 inch  
**Weight:** 5 kg | 11 lb

**PACKAGING :**

**Type:** Carton box  
**L:** 52 cm | 20.5 inch  
**W:** 51 cm | 20.1 inch  
**H:** 50 cm | 19.7 inch  
**Weight:** 7,8 kg | 17.2 lb

# PARROT

INDIA MAHDAVI

2015



Light pink

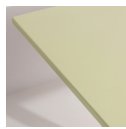

Light yellow



Turquoise



Cream-pink  
Pattern



Light green-  
Dark green  
Pattern

## Tables

-

### MATERIALS

Plate : Enameled steel; Leg structure : steel, with smooth powder coating

### COLORS

Light pink, Light yellow, Turquoise, Cream-pink patter, Light green-dark green patter

### ORIGIN

France and Portugal

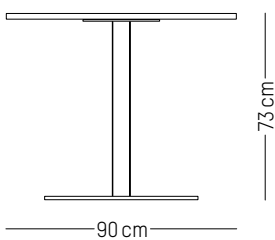

## Small

-

**L:** 90 cm | 35.4 inch  
**W:** 90 cm | 35.4 inch  
**H:** 73 cm | 28.7 inch  
**POIDS:** 39 kg | 86 lb

### PACKAGING :

**L:** 100 cm | 39.4 inch  
**W:** 100 cm | 39.4 inch  
**H:** 80 cm | 31.5 inch  
**Weight:** 55 kg | 121 lb

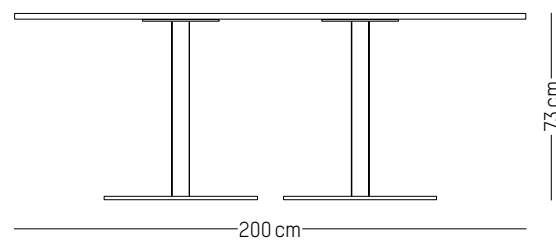

## Large

-

**L:** 200 cm | 78.9 inch  
**W:** 90 cm | 35.4 inch  
**H:** 73 cm | 28.7 inch  
**Weight:** 80 kg | 176.4 lb

### PACKAGING :

**L:** 210 cm | 82.7 inch  
**W:** 100 cm | 39.4 inch  
**H:** 80 cm | 31.5 inch  
**Weight:** 95 kg | 209 lb

# TAVLA

## STUDIO POOL

2020



Black and natural

### Dining tables

-

#### MATERIALS

Wooden top with marquetry/inlay of natural & black walnut veneers; Legs in steel with matte grained powder coating

#### COLORS

Black and natural

#### ORIGIN

Europe

#### TECHNICAL SPECIFICATIONS

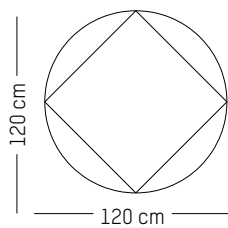

#### Round

-

**Ø:** 120 cm | 47.2 inch  
**H:** 75 cm | 29.5 inch  
**Weight:** 32 kg | 70.5 lb

#### PACKAGING :

**L:** 150 cm | 59 inch  
**L:** 150 cm | 59 inch  
**H:** 15 cm | 6 inch  
**Weight:** 55 kg | 121.3 lb

#### Assembly

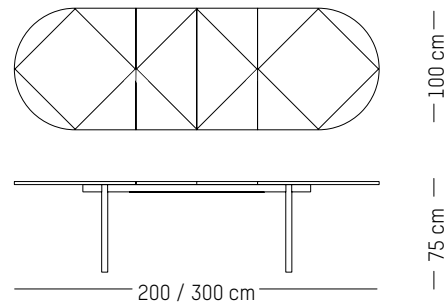
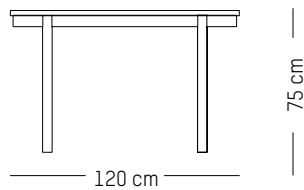

#### Extendable oval

-

**L:** 200/300 cm - 2 extensions of 50cm  
28.5 inch - 2 extensions of 19.6 inch  
**W:** 100 cm | 39.3 inch  
**H:** 75 cm | 29.5 inch  
**Weight:** 60kg | 132.2 lb

#### PACKAGING :

**Type :** Wood box  
**L:** 215 cm | 85 inch  
**W:** 110 cm | 43.3 inch  
**H:** 15 cm | 6 inch  
**Weight:** 95 kg | 209.5 lb

#### Assembly

# TAVLA

## STUDIO POOL

2020



Black and natural

### Coffee table

-

#### MATERIALS

Wooden top with marquetry/inlay of natural & black walnut veneers; Legs in wood with black walnut veneer

#### COLORS

Black and natural

#### ORIGIN

Europe

#### TECHNICAL SPECIFICATIONS

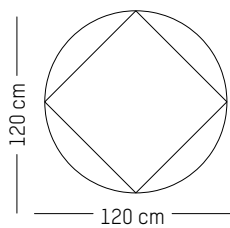

### Round Coffee table

-

**Ø:** 120 cm | 47.2 inch

**H:** 25 cm | 9.8 inch

**Weight:** 40 kg | 88.2 lb

#### PACKAGING :

**L:** 150 cm | 59 inch

**L:** 150 cm | 59 inch

**H:** 40 cm | 15.7 inch

**Weight:** 50 kg | 110 lb

#### Assembly

# TAVLA

## STUDIO POOL

2020



Black



Coral



Blue



Mint green

FOR CONTRACT PROJECT WITH MINIMUM QUANTITY

### Bistro tables

-

#### MATERIALS

Wooden top with marquetry/inlay of natural & black walnut veneers; Legs in steel with matte grained powder coating

#### COLOURS

Black and natural wooden top

Leg: black, coral, blue, mint green

#### ORIGIN

Europe

#### TECHNICAL SPECIFICATIONS

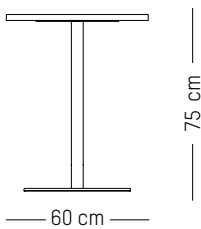
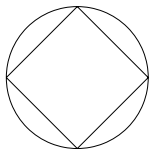

### Round bistro small

-

Ø: 60 cm | 23.6 inch

H: 75 cm | 29.5 inch

Weight: 19,9 kg | 43.9 lb

#### PACKAGING :

L: 80 cm | 31,5 inch

L: 65 cm | 25,6 inch

H: 7 cm | 2.8 inch

Weight: 21 kg | 46.3 lb

#### Assembly

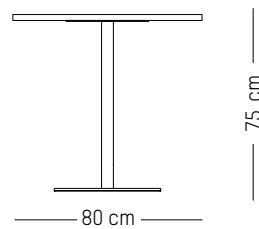
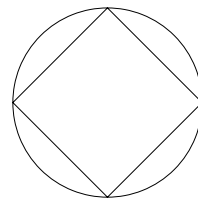

### Round bistro large

-

Ø: 80 cm | 31.5 inch

H: 75 cm | 29.5 inch

Weight: 22,4 kg | 49.4 lb

#### PACKAGING :

L: 80 cm | 31,5 inch

L: 85 cm | 33,5 inch

H: 7 cm | 2.8 inch

Weight: 24 kg | 53 lb

#### Assembly

# TAVLA

## STUDIO POOL

2020

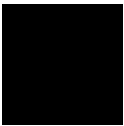

Black



Coral



Blue



Mint green

FOR CONTRACT PROJECT WITH MINIMUM QUANTITY

### Bistro tables

-

#### MATERIALS

Wooden top with marquetry/inlay of natural & black walnut veneers; Legs in steel with matte grained powder coating

#### COLOURS

Black and natural wooden top

Leg: black, coral, blue, mint green

#### ORIGIN

Europe

#### TECHNICAL SPECIFICATIONS



58

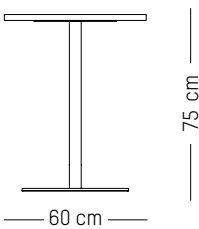
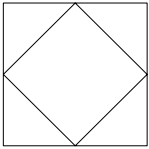

### Square bistro small

-

**L:** 60 cm | 23.6 inch

**W:** 60 cm | 23.6 inch

**H:** 75 cm | 29.5 inch

**Weight:** 21,7 kg | 47.9 lb

#### PACKAGING :

**L:** 80 cm | 31,5 inch

**L:** 65 cm | 25,6 inch

**H:** 7 cm | 2.8 inch

**Weight:** 23 kg | 51 lb

#### Assembly

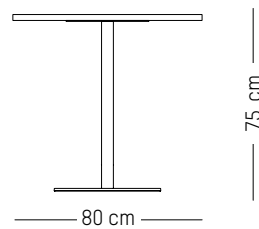
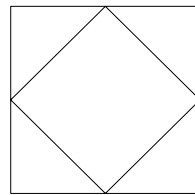

### Square bistro large

-

**L:** 80 cm | 31.5 inch

**W:** 80 cm | 31.5 inch

**H:** 75 cm | 29.5 inch

**Weight:** 25,2 kg | 55.6 lb

#### PACKAGING :

**L:** 80 cm | 31,5 inch

**L:** 85 cm | 33,5 inch

**H:** 7 cm | 2.8 inch

**Weight:** 27 kg | 60 lb

#### Assembly



# TAVLA

## STUDIO POOL

2020



Black

Coral

Blue

Mint green

FOR CONTRACT PROJECT WITH MINIMUM QUANTITY

### High tables

-

#### MATERIALS

Wooden top with marquetry/inlay of natural & black walnut veneers; Legs in steel with matte grained powder coating

#### COLOURS

Black and natural wooden top

Leg: black, coral, blue, mint green

#### ORIGIN

Europe

#### TECHNICAL SPECIFICATIONS

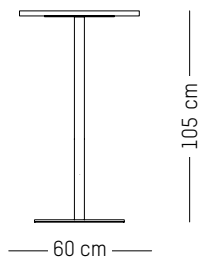
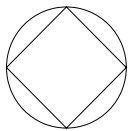

### Round high

-

Ø: 60 cm | 23.6 inch

H: 105 cm | 41.34 inch

Weight: 20,6 kg | 45.4 lb

#### PACKAGING :

L: 110 cm | 43,3 inch

L: 65 cm | 25,6 inch

H: 7 cm | 2.8 inch

Weight: 22 kg | 48.5 lb

#### Assembly

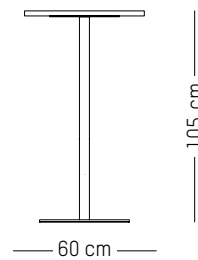
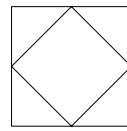

### Square high

-

L: 60 cm | 23.6 inch

W: 60 cm | 23.6 inch

H: 105 cm | 41.34 inch

Weight: 22,5 kg | 49.6 lb

#### PACKAGING :

L: 110 cm | 43,3 inch

L: 65 cm | 25,6 inch

H: 7 cm | 2.8 inch

Weight: 24 kg | 53 lb

#### Assembly

# TRAME\*

AC/AL STUDIO

2014



Black



Anthracite\*



White

## Chair

-

### MATERIALS

Steel with matte grained powder coating

### COLORS

Black, Anthracite, White

### ORIGIN

Europe

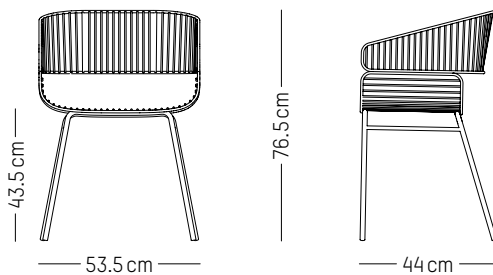

**L:** 53,5 cm | 21 inch  
**D:** 44 cm | 17.3 inch  
**H:** 76,5 cm | 30.1 inch  
**H (seat):** 43,5 cm | 17.1 inch  
**Weight:** 8 kg | 17.6 lb

### PACKAGING :

**L:** 80 cm | 31.5 inch  
**W:** 60 cm | 23.6 inch  
**H:** 52 cm | 20.5 inch  
**Weight:** 9,8 kg | 21.6 lb

\* While stocks last

# TRAME

AC/AL STUDIO

2014

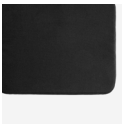

Black

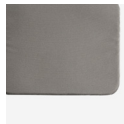

Grey



White

## Cushions

-

## MATERIALS

Cover in acrylic, quickdry foam in polyethylene

## COLORS

Black, Grey, White

## ORIGIN

France

## TECHNICAL SPECIFICATIONS

Suitable for outdoor use

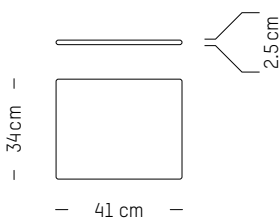

## Seat cushion

-

**L:** 41 cm | 16.1 inch  
**W:** 34 cm | 13.4 inch  
**H:** 2,5 cm | 1 inch  
**Weight:** 0,5 kg | 1.1 lb

## PACKAGING :

**L:** 45 cm | 17.7 inch  
**W:** 45 cm | 17.7 inch  
**H:** 5 cm | 2 inch  
**Weight:** 1 kg | 2.2 lb

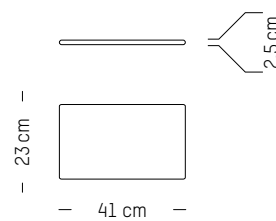

## Back cushion

-

**L:** 41 cm | 16.1 inch  
**W:** 23 cm | 9.1 inch  
**H:** 2,5 cm | 1 inch  
**Weight:** 0,5 kg | 1.1 lb

## PACKAGING :

**L:** 45 cm | 17.7 inch  
**W:** 45 cm | 17.7 inch  
**H:** 5 cm | 2 inch  
**Weight:** 1 kg | 2.2 lb

# UNIFY

ANNE HARVALA

2020



## Side table

-

### MATERIALS

Wooden top with matte lacquered oak veneer  
Leg structure : Steel with matte grained powder coating

### COLORS

Grey-brown, Red-brown, Blush

### ORIGIN

Europe

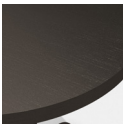

Grey-brown

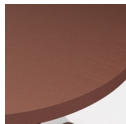

Red-brown

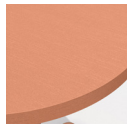

Blush

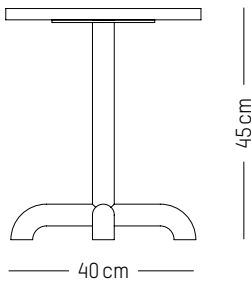

**Ø:** 40 cm | 15.7 inch  
**H:** 45 cm | 17.7 inch  
**Weight:** 5 kg | 11 lb

### PACKAGING :

**L:** 42 cm | 16.5 inch  
**W:** 42 cm | 16.5 inch  
**H:** 47 cm | 18.5 inch  
**Weight:** 7 kg | 15 lb

# UNIFY

ANNE HARVALA

2020



Grey-brown

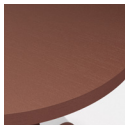

Red-brown

## Round dining table

-

### MATERIALS

Wooden top with matte lacquered oak veneer  
Leg structure : Steel with matte grained powder coating

### COLORS

Red-brown, Grey-brown

### ORIGIN

Europe

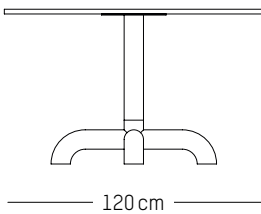

## Round dining table

-

**Ø:** 120 cm | 47.2 inch  
**H:** 73 cm | 29 inch  
**Weight:** 33 kg | 72.5 lb

### PACKAGING :

- Carton box 1  
**L:** 122 cm | 48 inch  
**W:** 122 cm | 48 inch  
**H:** 30 cm | 11.8 inch  
**Weight:** 20 cm | 44 inch

- Carton box 2  
**L:** 60 cm | 23.6 inch  
**W:** 60 cm | 23.6 inch  
**H:** 25 cm | 9.8 inch  
**Weight:** 18 kg | 39.7 lb

### Assembly

# UNIFY

ANNE HARVALA

2020



## Rectangular dining table

-

### MATERIALS

Wooden top with matte lacquered oak veneer  
Leg structure : Steel with matte grained powder coating

### COLORS

Grey-brown, Red-brown

### ORIGIN

Europe



Grey-brown

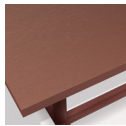

Red-Brown

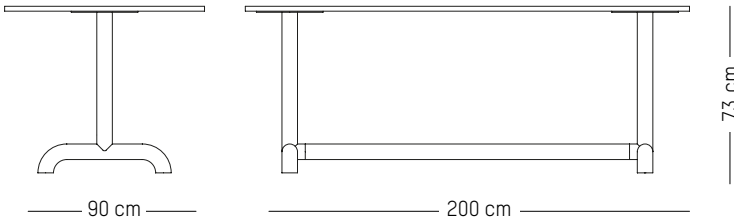

## Rectangular dining table

-

**L:** 200 cm | 79 inch  
**W:** 90 cm | 35 inch  
**H:** 73 cm | 29 inch  
**Weight:** 46 kg | 102 lb

### PACKAGING :

- Carton box 1  
**L:** 202 cm | 79 inch  
**W:** 92 cm | 36 inch  
**H:** 5 cm | 2 inch  
**Weight:** 30 kg | 66.1 lb

- Carton box 2  
**L:** 180 cm | 71 inch  
**W:** 62 cm | 24 inch  
**H:** 16 cm | 6.3 inch  
**Weight:** 22 kg | 48.5 lb

### Assembly

# UNIFY

ANNE HARVALA

2020



Grey-brown

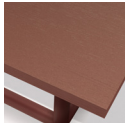

Red-Brown

## Benches

-

### MATERIALS

Wooden top with matte lacquered oak veneer  
Leg structure : Steel with matte grained powder coating

### COLORS

Grey-brown, Red-brown

### ORIGIN

Europe

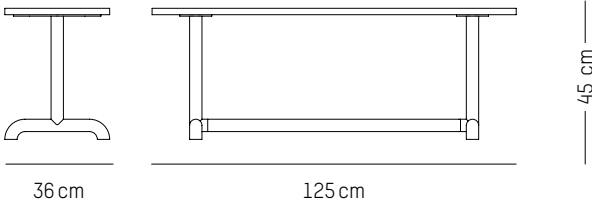

## Bench 125 cm

-

**L:** 125 cm | 49.2 inch  
**W:** 36 cm | 14.2 inch  
**H:** 45 cm | 17.7 inch  
**Weight:** 15 kg | 33 lb

### PACKAGING :

- Carton box 1  
**L:** 127 cm | 50 inch  
**W:** 38 cm | 15 inch  
**H:** 11 cm | 4.3 inch  
**Weight:** 10 cm | 22 inch

- Carton box 2  
**L:** 127 cm | 50 inch  
**W:** 38 cm | 15 inch  
**H:** 3 cm | 1.2 inch  
**Weight:** 8 kg | 17.6 lb

### Assembly

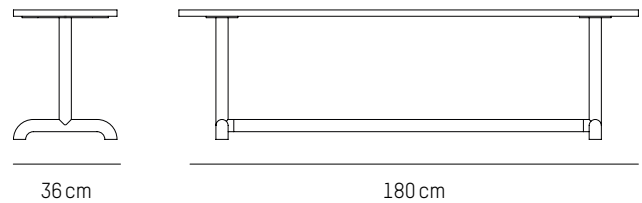

## Bench 180 cm

-

**L:** 180 cm | 71 inch  
**W:** 36 cm | 14.2 inch  
**H:** 45 cm | 17.7 inch  
**Weight:** 21 kg | 46.3 lb

### PACKAGING :

- Carton box 1  
**L:** 182 cm | 71.7 inch  
**W:** 38 cm | 15 inch  
**H:** 11 cm | 4.3 inch  
**Weight:** 13 cm | 28.7 inch

- Carton box 2  
**L:** 182 cm | 71.7 inch  
**W:** 38 cm | 15 inch  
**H:** 3 cm | 1.2 inch  
**Weight:** 11 kg | 24.3 lb

### Assembly

# UNIFY

ANNE HARVALA

2020



Blush

FOR CONTRACT PROJECT WITH MINIMUM QUANTITY

## Benches

-

### MATERIALS

Wooden top with matte lacquered oak veneer  
Leg structure : Steel with matte grained powder coating

### COLOURS

Blush

### ORIGIN

Europe

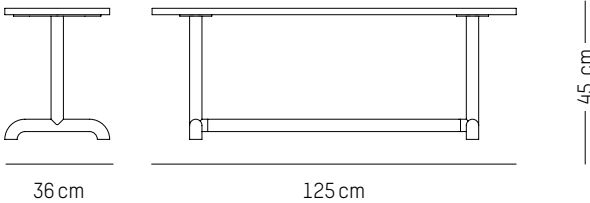

## Bench 125 cm

-

**L:** 125 cm | 49.2 inch  
**W:** 36 cm | 14.2 inch  
**H:** 45 cm | 17.7 inch  
**Weight:** 15 kg | 33 lb

### PACKAGING :

- Carton box 1  
**L:** 127 cm | 50 inch  
**W:** 38 cm | 15 inch  
**H:** 11 cm | 4.3 inch  
**Weight:** 10 cm | 22 inch

- Carton box 2  
**L:** 127 cm | 50 inch  
**W:** 38 cm | 15 inch  
**H:** 3 cm | 1.2 inch  
**Weight:** 8 kg | 17.6 lb

### Assembly

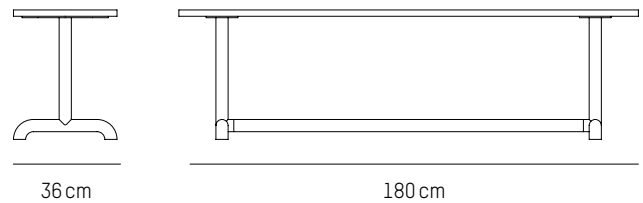

## Bench 180 cm

-

**L:** 180 cm | 71 inch  
**W:** 36 cm | 14.2 inch  
**H:** 45 cm | 17.7 inch  
**Weight:** 21 kg | 46.3 lb

### PACKAGING :

- Carton box 1  
**L:** 182 cm | 71.7 inch  
**W:** 38 cm | 15 inch  
**H:** 11 cm | 4.3 inch  
**Weight:** 13 cm | 28.7 inch

- Carton box 2  
**L:** 182 cm | 71.7 inch  
**W:** 38 cm | 15 inch  
**H:** 3 cm | 1.2 inch  
**Weight:** 11 kg | 24.3 lb

### Assembly



# UNIFY

ANNE HARVALA

2020

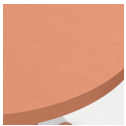

Blush

FOR CONTRACT PROJECT WITH MINIMUM QUANTITY

## Round dining table

-

### MATERIALS

Wooden top with matte lacquered oak veneer  
Leg structure : Steel with matte grained powder coating

### COLOURS

Blush

### ORIGIN

Europe

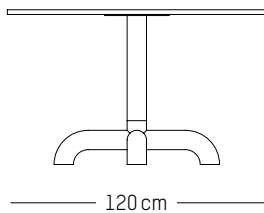

## Round dining table

-

**Ø:** 120 cm | 47.2 inch  
**H:** 73 cm | 29 inch  
**Weight:** 33 kg | 72.5 lb

### PACKAGING :

- Carton box 1  
**L:** 122 cm | 48 inch  
**W:** 122 cm | 48 inch  
**H:** 30 cm | 11.8 inch  
**Weight:** 20 kg | 44 lb

- Carton box 2  
**L:** 60 cm | 23.6 inch  
**W:** 60 cm | 23.6 inch  
**H:** 25 cm | 9.8 inch  
**Weight:** 18 kg | 39.7 lb

### Assembly

**UNIFY**

FOR CONTRACT PROJECT WITH MINIMUM QUANTITY

ANNE HARVALA

2020



### Rectangular dining table

-

#### MATERIALS

Wooden top with matte lacquered oak veneer  
Leg structure : Steel with matte grained powder coating

#### COLOURS

Blush

#### ORIGIN

Europe

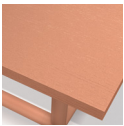

Blush

68

13

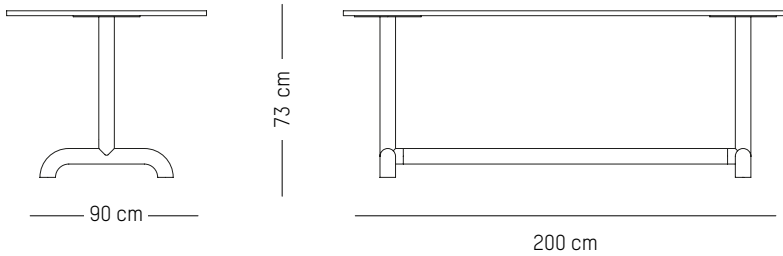

### Rectangular dining table

-

**L:** 200 cm | 79 inch  
**W:** 90 cm | 35 inch  
**H:** 73 cm | 29 inch  
**Weight:** 46 kg | 102 lb

#### PACKAGING :

- Carton box 1  
**L:** 202 cm | 79.53 inch  
**W:** 92 cm | 36.22 inch  
**H:** 5 cm | 2 inch  
**Weight:** 30 kg | 66.1 lb

- Carton box 2  
**L:** 80 cm | 31.50 inch  
**W:** 62 cm | 24.41 inch  
**H:** 16 cm | 6.30 inch  
**Weight:** 22kg | 48.5 lb

#### Assembly

# UNIFY

ANNE HARVALA

2020

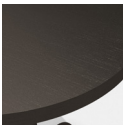

Grey-brown

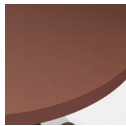

Red-Brown

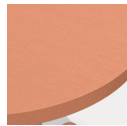

Blush

FOR CONTRACT PROJECT WITH MINIMUM QUANTITY

## Bistro round table

-

### MATERIALS

Wooden top with matte lacquered oak veneer

Leg structure : Steel with matte grained powder coating

### COLOURS

Grey-brown, Red-brown, Blush

### ORIGIN

Europe

### TECHNICAL SPECIFICATIONS

Adjustable feet

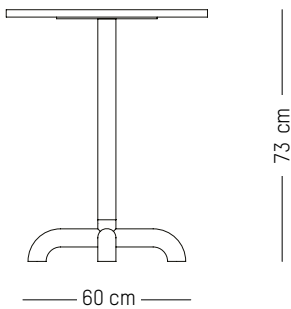

## Round bistro table

-

Ø: 60 cm | 23.6 inch

H: 73 cm | 29 inch

Weight: 11 kg | 24.2 lb

### PACKAGING :

L: 62 cm | 24.4 inch

W: 62 cm | 23.6 inch

H: 20 cm | 7.8 inch

Weight: 13 kg | 28.7 lb

### Assembly

# UPHOLSTERY

**LILY**

*FÄRG & BLANCHE*

2022



## Sofa and armchair

### MATERIALS

Steel frame and ply, steel springs, 100% polyurethane fire-proof HR foam.

### COLORS

4 collections of fabric available.  
See our upholstery collections brochure.

### ORIGIN

Europe

Lily armchairs and sofas are manufactured to order.

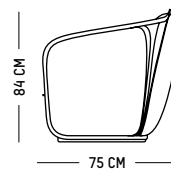
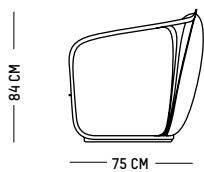
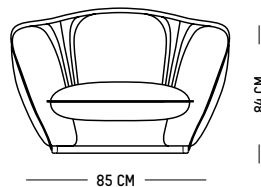
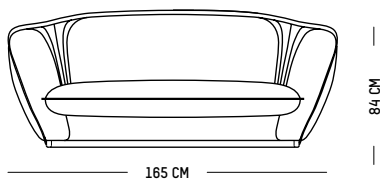

## Sofa

**L:** 165 cm | 65 inch  
**W:** 75 cm | 30 inch  
**H:** 84 cm | 33 inch  
**Weight:** 59 kg | 130 lb

### PACKAGING :

**Type:** Wooden crate  
**L:** 172 cm | 68 inch  
**W:** 85 cm | 33 inch  
**H:** 102 cm | 40 inch  
**Weight:** 90kg | 198 lb

## Armchair

**L:** 85 cm | 33 inch  
**W:** 75 cm | 30 inch  
**H:** 84 cm | 33 inch  
**H1:** 40 cm | 15.7 inch  
**Weight:** 39 kg | 86 lb

### PACKAGING :

**Type:** Wood box  
**L:** 92 cm | 36 inch  
**W:** 85 cm | 33 inch  
**H:** 102 cm | 40 inch  
**Weight:** 60 kg | 132 lb



**Sofa and armchair**

**MATERIALS**

Steel with matte grained powder coating + oak wood  
**Seat and back foam:** 100% PU foam 80g/m<sup>2</sup>  
 Cushion in mix of PU and wadding, fabric to be chosen by client

**ORIGIN**

Europe

**TECHNICAL SPECIFICATIONS**

Removable cushions

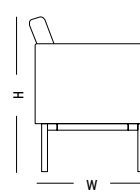
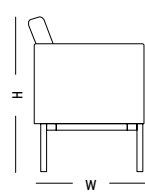
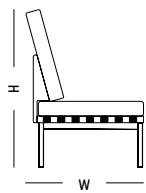
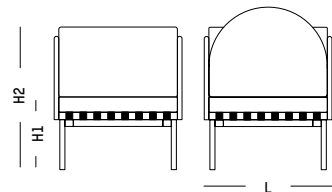
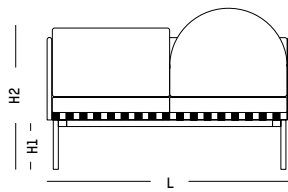
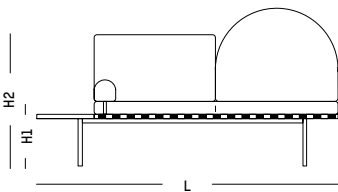

**Daybed**

**L:** 187 cm | 73.6 inch  
**W:** 71 cm | 28 inch  
**H:** 92 cm | 36.2 inch  
**H1:** 45 cm | 17.7 inch  
**Weight:** 45 kg | 92.2 lb

**PACKAGING :**

**Type:** Wood box  
**L:** 170 cm | 66.9 inch  
**W:** 90 cm | 35.4 inch  
**H:** 100 cm | 39.4 inch  
**Weight:** 90 kg | 198 lb

Options : round cushion,  
 square cushion, headrest,  
 walnut wood

**Sofa with 2 armrests**

**L:** 146 cm | 57.5 inch  
**W:** 71 cm | 28 inch  
**H:** 92 cm | 36.2 inch  
**H1:** 45 cm | 17.7 inch  
**H2:** 86 cm | 33.9 inch  
**Weight:** 50 kg | 110.2 lb

**PACKAGING :**

**Type:** Wood box  
**L:** 170 cm | 66.9 inch  
**W:** 90 cm | 35.4 inch  
**H:** 100 cm | 39.4 inch  
**Weight:** 95 kg | 209 lb

Options : round cushion,  
 square cushion, walnut wood  
 1 or 2 armrest

**Armchair with 2 armrests**

**L:** 76 cm | 30 inch  
**W:** 71 cm | 28 inch  
**H:** 92 cm | 36.2 inch  
**H1:** 45 cm | 17.7 inch  
**H2:** 86 cm | 33.9 inch  
**Weight:** 34 kg | 75 lb

**PACKAGING :**

**Type:** Wood box  
**L:** 146 cm | 57.5 inch  
**W:** 88 cm | 34.6 inch  
**H:** 100 cm | 39.4 inch  
**Weight:** 70 kg | 154 lb

Options : round cushion,  
 square cushion, walnut wood  
 1 or 2 armrest

# GRID

## STUDIO POOL

2016



### Stool and coffee table

-

#### MATERIALS

Steel with matte grained powder coating + oak wood

Seat and back foam: 100% PU foam 80g/m<sup>2</sup>

Cushion in mix of PU and wadding, fabric to be chosen by client

#### ORIGIN

Europe

#### TECHNICAL SPECIFICATIONS

Removable cushions

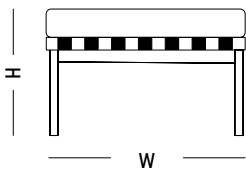

### Stool

-

L : 68 cm | 27 inch

W : 68 cm | 27 inch

H : 45 cm | 18 inch

Weight : 17 kg | 38 lb

#### PACKAGING :

Type : Wood box

L : 90 cm | 36 inch

W : 88 cm | 35 inch

H : 100 cm | 40 inch

Weight : 55 kg | 122 lb

Options : walnut wood

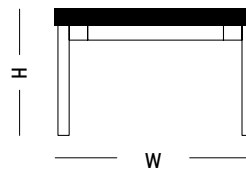

### Coffee table

-

L : 68 cm | 27 inch

W : 68 cm | 27 inch

H : 33 cm | 12 inch

Weight : 21 kg | 47 lb

#### PACKAGING :

Type : Wood box

L : 90 cm | 36 inch

W : 88 cm | 35 inch

H : 100 cm | 40 inch

Weight : 60 kg | 133 lb

Options : walnut wood

# GRID - PRE-COMPOSED FABRIC SELECTION

## SELECTED FABRICS

### 1/ CHOOSE MODULES

### 2/ FABRICS : SHADES OF GREY

#### Grey-black



Base  
Cat.2  
FIELD 2 - 182



Round cushion  
Cat.2  
VITA NOIR ITA12



Headrest  
Cat.2  
VITA NOIR ITA12

#### Grey-blue



Base  
Cat.3  
FIELD 2 - 222



Round cushion  
Cat.2  
VITA SWAN ITA42



Headrest  
Cat.2  
VITA SWAN ITA42

#### Grey-beige



Base  
Cat.3  
FIELD 2 - 123



Round cushion  
Cat.2  
VITA ALPACA ITA46



Headrest  
Cat.2  
VITA ALPACA ITA46

### 3/ WOOD, METAL AND OPTIONS



Oak Wood  
already included





**EXAMPLES OF MODULAR ASSEMBLY : GRID modules allow to create multiple configurations to equip entire lounge spaces.**



**2 seater sofa without armrest  
+ armchair without armrest**

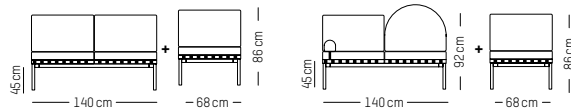

**2 seater sofa without armrest  
+ armchair with 1 armrest**  
*(right or left)*

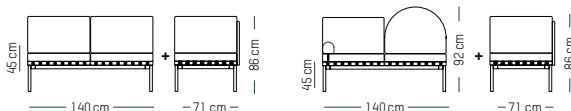

**2 seater sofa without armrest  
+ 2 armchairs with 1 armrest**

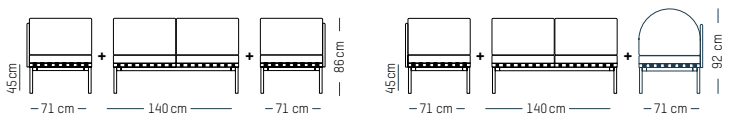

**2 seater sofa without armrest  
+ 1 armchair with 1 armrest + 1 pouf**  
*(right or left)*

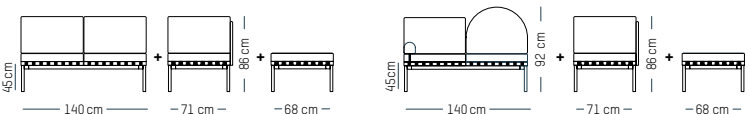

**Armchairs and Stools**

-

**MATERIALS**

Steel with matte grained powder coating

Seat and back foam: PU foam 40kg/m<sup>3</sup> + wadding 100% PE 80g/m<sup>2</sup>

Cover: fabric to be chosen by client (non removable covers).

**ORIGIN**

Europe

**TECHNICAL SPECIFICATIONS**

DRY CLEAN

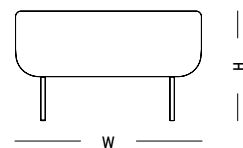
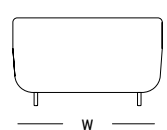
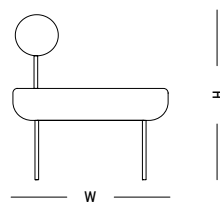
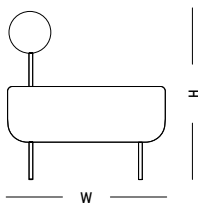
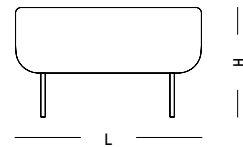
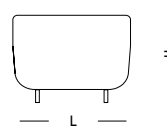
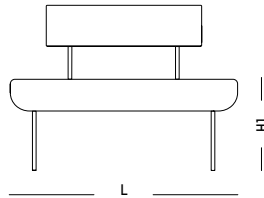
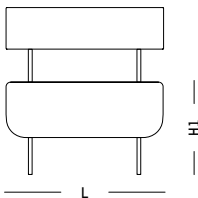
**Medium Armchair**

-

**L:** 68 cm | 26.8 inch  
**W:** 68 cm | 26.8 inch  
**H:** 72.5 cm | 28.5 inch  
**H1:** 40 cm | 15.8 inch  
**Weight:** 17 kg | 37.5 lb

**PACKAGING :**

**Type:** Wood box  
**L:** 53cm | 20.9 inch  
**W:** 71cm | 27.9 inch  
**H:** 43 cm | 16.9 inch  
**Weight:** 24 kg | 12.6 lb

**Large Armchair**

-

**L:** 99,5 cm | 39.2 inch  
**W:** 68 cm | 26.8 inch  
**H:** 72.5 cm | 28.5 inch  
**H1:** 40 cm | 15.8 inch  
**Weight:** 18 kg | 39.7 lb

**PACKAGING :**

**Type:** Wood box  
**L:** 103cm | 40.5 inch  
**W:** 71cm | 27.9 inch  
**H:** 76 cm | 29.9 inch  
**Weight:** 31 kg | 68 lb

**Small Stool**

-

**L:** 50 cm | 19.7 inch  
**W:** 68 cm | 26.8 inch  
**H:** 40 cm | 15.8 inch  
**Weight:** 14 kg | 30.9 lb

**PACKAGING :**

**Type:** Wood box  
**L:** 53cm | 20.9 inch  
**W:** 71cm | 27.9 inch  
**H:** 43 cm | 16.9 inch  
**Weight:** 24 kg | 53 lb

**Medium Stool**

-

**L:** 68 cm | 26.8 inch  
**W:** 68 cm | 26.8 inch  
**H:** 40 cm | 15.8 inch  
**Weight:** 14,5 kg | 32 lb

**PACKAGING :**

**Type:** Wood box  
**L:** 53cm | 20.9 inch  
**W:** 71cm | 27.9 inch  
**H:** 43 cm | 16.9 inch  
**Weight:** 25 kg | 55 lb

# HOFF - PRE-COMPOSED FABRIC SELECTION

## SELECTED FABRICS

### 1/ CHOOSE MODULES

### 2/ FABRICS : SHADES OF GREY

#### Grey-black



Cat.3  
STEELCUT TRI0 3 - 124



Cat.2  
FIELD 2 - 182



Cat.3  
SAVOY 60198



STEELCUT TRI0 3 - 124 / FIELD 2 - 182

#### Grey-blue



Cat.3  
STEELCUT TRI0 3 - 205



Cat.2  
FIELD 2 - 222



Cat.3  
SAVOY 66165



STEELCUT TRI0 3 - 205 / FIELD 2 - 222

#### Grey-beige



Cat.3  
STEELCUT TRI0 3 - 616



Cat.2  
FIELD 2 - 123



Cat.3  
SAVOY 61221



STEELCUT TRI0 3 - 616 / FIELD 2 - 123



FIELD 2 - 182 / SAVOY 60198



FIELD 2 - 222 / SAVOY 66165



FIELD 2 - 123 / SAVOY 61221



SAVOY 60198



SAVOY 66165



SAVOY 61221



STEELCUT TRI0 3 - 124



STEELCUT TRI0 3 - 205



STEELCUT TRI0 3 - 616

# NUBILO

## CONSTANCE GUISSET

2014 & 2015



### Sofa and armchair

-

#### MATERIALS

Steel with matte grained powder coating

Seat and back foam: PU foam 45kg/m<sup>3</sup>

Cushions 100% PU foam 80G/m<sup>2</sup>, cover fabric to be chosen by client

#### ORIGIN

Europe

#### TECHNICAL SPECIFICATIONS

Removable cushions



78

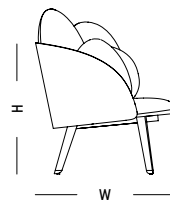
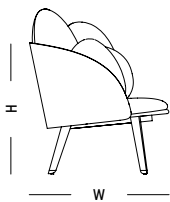
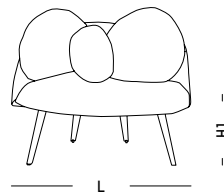
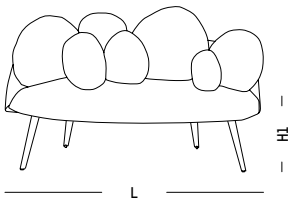

### Sofa

-

**L:** 155 cm | 61 inch

**W:** 75 cm | 29.5 inch

**H:** 65 cm | 25.6 inch

**H1:** 40 cm | 15.7 inch

**Weight:** 50 kg | 110.2 lb

#### PACKAGING :

**Type:** Wood box

**L:** 170 cm | 66.9 inch

**W:** 80 cm | 31.5 inch

**H:** 70 cm | 27.6 inch

**Weight:** 80kg | 176 lb

### Armchair

-

**L:** 77 cm | 30.3 inch

**W:** 70 cm | 27.6 inch

**H:** 65 cm | 25.6 inch

**H1:** 40 cm | 15.7 inch

**Weight:** 20 kg | 44.1 lb

#### PACKAGING :

**Type:** Wood box

**L:** 90 cm | 35.4 inch

**W:** 80 cm | 31.5 inch

**H:** 70 cm | 27.6 inch

**Weight:** 40 kg | 88 lb

# NUBILO - PRE-COMPOSED FABRIC SELECTION

SELECTED FABRICS

## 1/ CHOOSE MODULES

## 2/ FABRICS : SHADES OF GREY

### Grey-black

Base  
Cat.3  
STEELCUT TRIO 3 - 124

Set 1  
Cat.2  
FIELD 2 - 182

Set 2  
Cat.3  
SAVOY 60198

### Grey-blue

Base  
Cat.3  
STEELCUT TRIO 3 - 205

Set 1  
Cat.2  
FIELD 2 - 222

Set 2  
Cat.3  
SAVOY 66165

### Grey-beige

Base  
Cat.3  
STEELCUT TRIO 3 - 616

Set 1  
Cat.2  
FIELD 2 - 123

Set 2  
Cat.3  
SAVOY 61221



# **CUSTOMISE**

**MAKE YOUR OWN CUSTOM  
GRID, HOFF, NUBILO  
SOFAS, ARMCHAIRS & STOOLS**

**FOR LILY, PLEASE REFER TO FABRICS WITH \***

**Find in the next pages, a selection of fabrics that are suitable for our range  
of sofas and armchairs.**

**For other fabrics (COM), please contact us for price and lead time.**



# FABRICS' SELECTIONS

TO CREATE YOUR CUSTOM GRID, HOFF AND NUBILO SOFAS, ARMCHAIRS, STOOLS - FOR LILY, PLEASE REFER TO FABRICS WITH \*

## CATEGORY 1

GABRIEL CHILI\* | GABRIEL RHYTHM | GABRIEL RONDO



### 1A. GABRIEL CHILI\*

**MATERIAL:** 100% post-consumer recycled polyester fr  
 Width : 140cm - 55in  
 Weight : 470g/ml - 16,60z/Lin.yd

**DURABILITY:** 60.000 Martindale  
**ENVIRONMENT:** STANDARD 100 by OEKO-TEX®  
**FIRE STANDARDS:** BS EN 1021 1&2 Cigarette and Match/ BS EN 1021-1 Cigarette  
 BS 7176 Medium hazard/ BS 5852 Crib 5  
 BS 5852 Crib 5 / Call 117

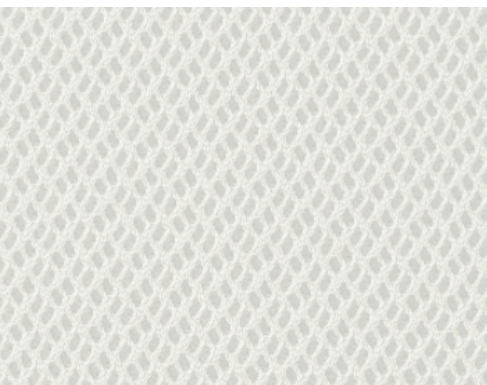

### 1B. GABRIEL RHYTHM

**MATERIAL:** 100% polyester/polyester flame retardant  
 Width : 140cm - 55in  
 Weight : 490g/ml - 17,240z/Lin.yd

**DURABILITY:** 70.000 Martindale  
**ENVIRONMENT:** STANDARD 100 by OEKO-TEX®

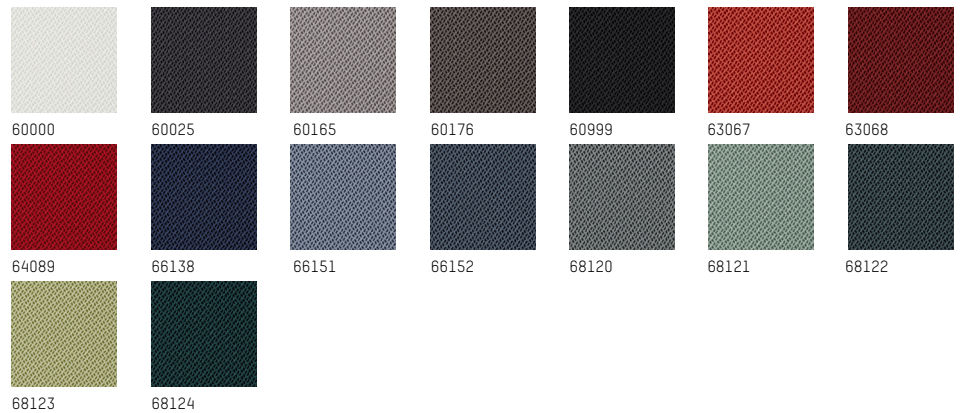



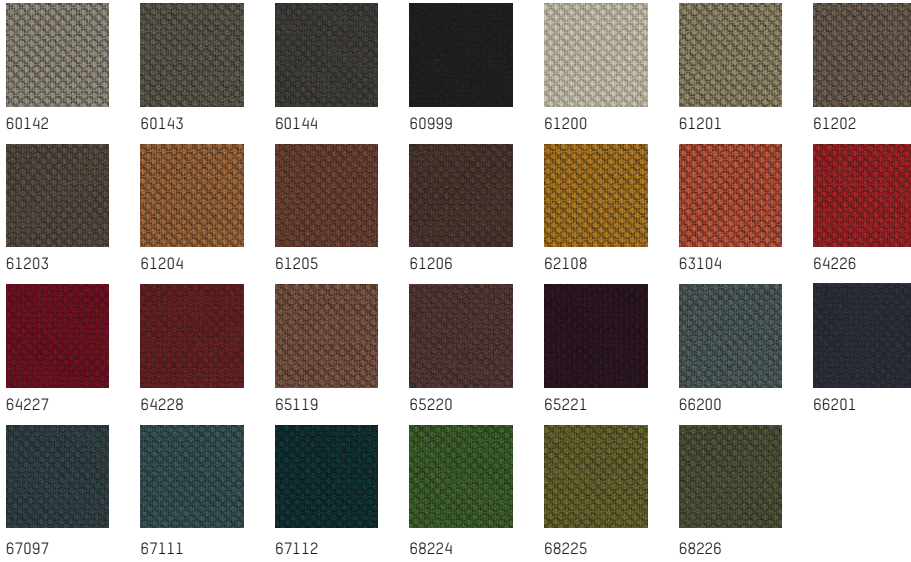

**1C. GABRIEL RONDO**

**MATERIAL:** 100% post-consumer recycled polyester fr  
 Width : 140cm - 55in  
 Weight : 470g/ml - 16,60z/Lin.yd

**DURABILITY:** 60.000 Martindale  
**ENVIRONMENT:** STANDARD 100 by OEKO-TEX®  
**FIRE STANDARDS:** BS EN 1021 1&2 Cigarette and Match/ BS EN 1021-1 Cigarette BS 7176 Medium hazard/ BS 5852 Crib 5 BS 5852 Crib 5 / Call 117

**CATEGORY 2**

**CAMIRA - VITA | GABRIEL FAME + FAME HYBRIDE | GABRIEL - CRISP | KVADRAT - FIELD 2  
 GABRIEL FOCUS + FOCUS MELANGE**

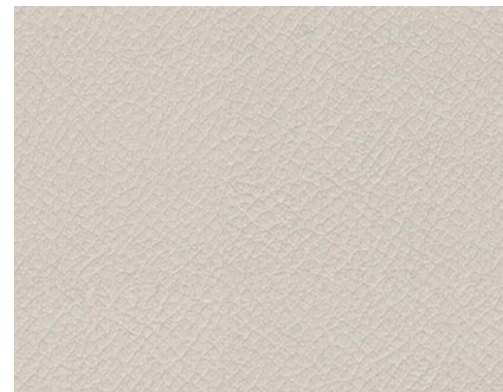

**2A. CAMIRA - VITA**

**MATERIAL:** Surface: 98% PVC, 2% PU  
 Substrate: 100% Cotton  
 Width : 140cm - 55in  
 Weight : 850g/ml - 29,980z/Lin.yd

**DURABILITY:** 100.000 turns  
**ENVIRONMENT:** Phthalate free  
**FIRE STANDARDS:** EN 1021-1 (cigarette) EN 1021-2 (match) /BS 7176 Low Hazard BS 5852 Ignition Source 5 :BS 7176 Medium Hazard /BS 5852 Ignition Source 7 (with interliner)



# FABRICS' SELECTIONS

TO CREATE YOUR CUSTOM GRID, HOFF AND NUBILO SOFAS, ARMCHAIRS, STOOLS - FOR LILY, PLEASE REFER TO FABRICS WITH \*

## CATEGORY 2

CAMIRA - VITA | GABRIEL FAME + FAME HYBRIDE\* | GABRIEL - CRISP | KVADRAT - FIELD 2  
GABRIEL FOCUS + FOCUS MELANGE

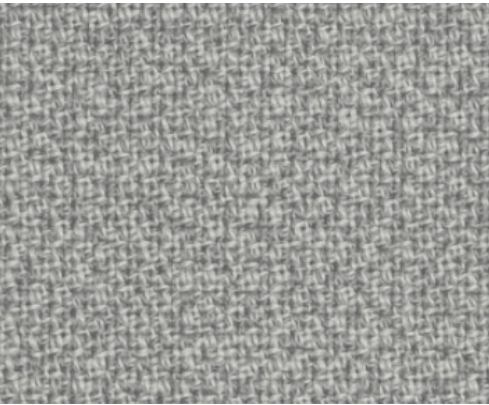

### 2B. GABRIEL FAME + FAME HYBRIDE\*

**MATERIAL:** 95% New Zealand wool  
/ 5% polyamide  
*Width : 140cm - 55in*  
*Weight : 630g/ml - 22,220z/Lin.yd*

**DURABILITY:** 150.000 Martindale  
**ENVIRONMENT:** STANDARD 100 by OEKO-TEX®  
**FIRE STANDARDS:** BS EN 1021 1&2 Cigarette  
and Match/ BS EN 1021-1 Cigarette  
BS 7176 Medium hazard/ BS 5852 Crib 5  
BS 5852 Crib 5 / Call 117





# FABRICS' SELECTIONS

TO CREATE YOUR CUSTOM GRID, HOFF AND NUBILO SOFAS, ARMCHAIRS, STOOLS - FOR LILY, PLEASE REFER TO FABRICS WITH \*

## CATEGORY 2

CAMIRA - VITA | GABRIEL FAME + FAME HYBRIDE | GABRIEL - CRISP | KVADRAT - FIELD 2  
GABRIEL FOCUS + FOCUS MELANGE

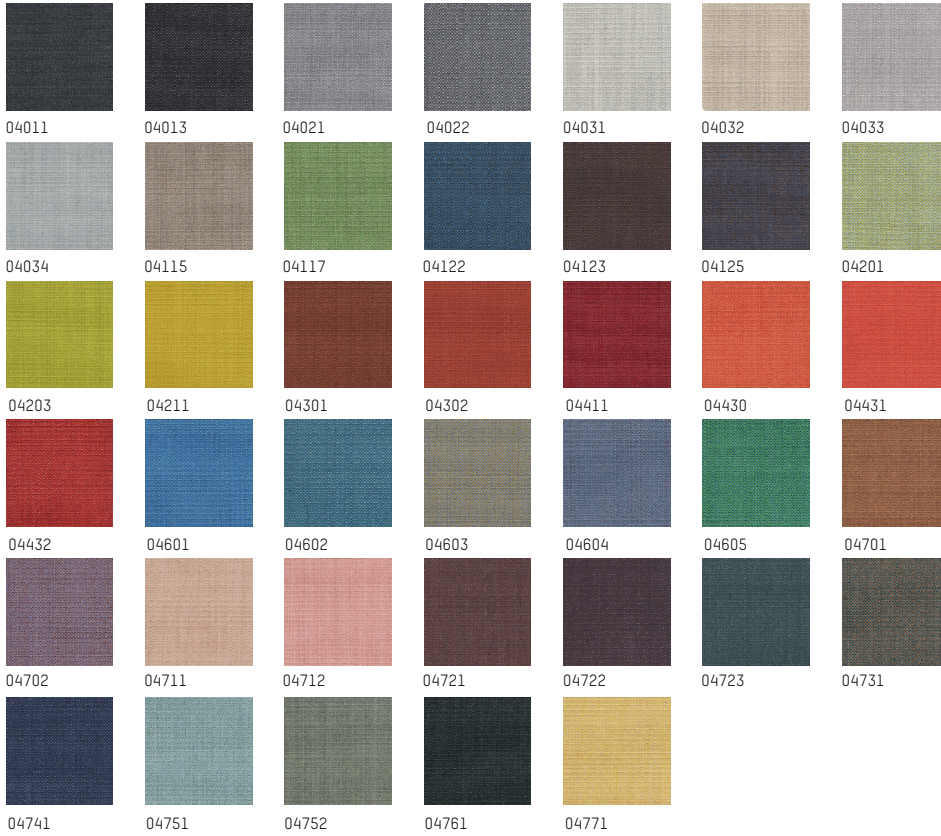

### 2C. GABRIEL - CRISP

**MATERIAL:** 93% New Zealand wool  
/ 7% polyamide  
Width: 140cm - 55in  
Weight: 460g/ml - 16,230z/Lin.yd

**DURABILITY:** 200.000 Martindale  
**ENVIRONMENT:** STANDARD 100 by OEKO-TEX®  
/ EU Ecolabel  
**FIRE STANDARDS:** BS EN 1021 1&2 Cigarette  
and Match/ BS EN 1021-1 Cigarette  
BS 7176 Medium hazard/ BS 5852 Crib 5  
BS 5852 Crib 5 / Call 117

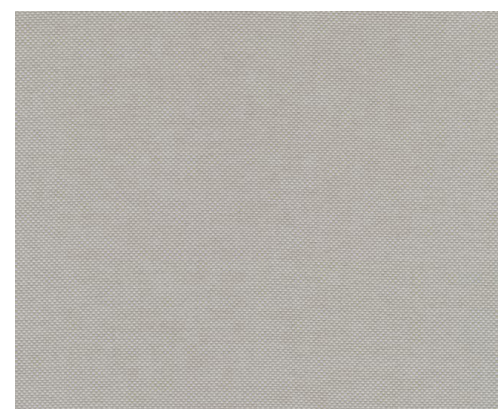
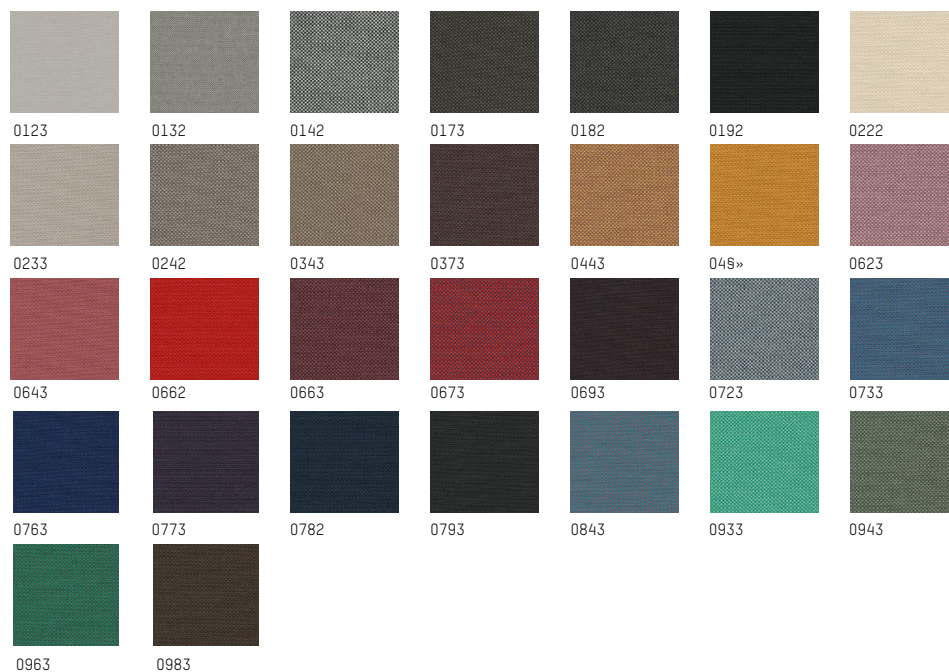

### 2D. KVADRAT - FIELD 2

**MATERIAL:** 100% Trevira CS  
Width: 140cm - 55in  
Weight: 450g/ml - 15,870z/Lin.yd

**DURABILITY:** 80.000 Martindale  
**ENVIRONMENT:** EU Ecolabel, Greenguard  
Gold, HPD, EPD  
**FIRE STANDARDS:** BS 5852 Crib 5  
EN 1021-1/2 / EN 13501-1 B-s1, d0



# FABRICS' SELECTIONS

TO CREATE YOUR CUSTOM GRID, HOFF AND NUBILO SOFAS, ARMCHAIRS, STOOLS - FOR LILY, PLEASE REFER TO FABRICS WITH \*

## CATEGORY 2

CAMIRA - VITA | GABRIEL FAME + FAME HYBRIDE | GABRIEL - CRISP | KVADRAT - FIELD 2  
GABRIEL FOCUS + FOCUS MÉLANGE

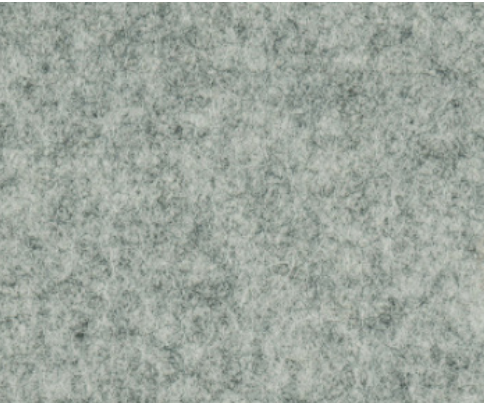

### 2E. GABRIEL FOCUS + FOCUS MÉLANGE

**MATERIAL:** 100% New Zealand wool  
Width : 140cm - 55in  
Weight : 660g/ml - 23,280z/Lin.yd

**DURABILITY:** 100.000 Martindale  
**ENVIRONMENT:** STANDARD 100 by OEKO-TEX® / EU Ecolabel

**FIRE STANDARDS:** BS EN 1021 1&2 Cigarette and Match / BS 5852 Part 1 0,1 Cigarette & match



# FABRICS' SELECTIONS

TO CREATE YOUR CUSTOM GRID, HOFF AND NUBILO SOFAS, ARMCHAIRS, STOOLS - FOR LILY, PLEASE REFER TO FABRICS WITH \*

## CATEGORY 3

CAMIRA - OCEANIC | GABRIEL - SAVOY | KVADRAT - CLAY - SAHCO | KVADRAT  
- STEELCUT 2 | KVADRAT - STEELCUT TRIO 3 | KVADRAT - GALAXY | KVADRAT- ENCIRCLE

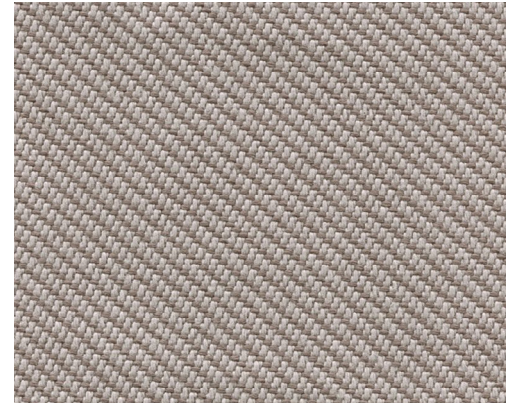
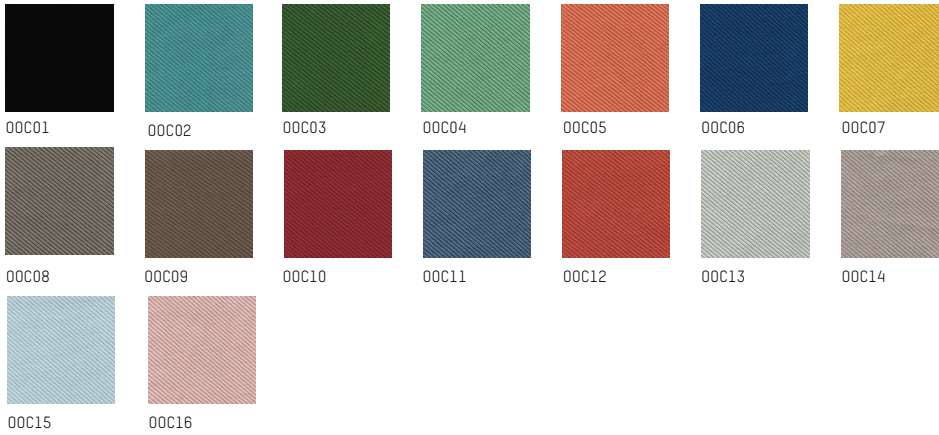

### 3A. CAMIRA - OCEANIC

**MATERIAL:** 100% post-consumer recycled polyester, including 50% SEAQUAL yarn.  
Width : 140cm - 55in  
Weight : 497g/ml - 17,530z/Lin.yd

**DURABILITY:** 135.000 Martindale

**ENVIRONMENT:** S EKO-TEX® Standard 100 / Certified to Indoor Advantage™ «Gold» / Made from 100% post-consumer recycled polyester / Non metallic dyestuffs.

**FIRE STANDARDS:** EN 1021 - 1 (cigarette) / EN 1021 - 2 (match) / BS 7176 Low Hazard / BS 5852 Ignition Source 5 with EnviroFlam5 / BS 7176 Medium Hazard with EnviroFlam5



### 3B. GABRIEL - SAVOY

**MATERIAL:** 100% Trevira CS  
Width : 140cm - 55in  
Weight : 600g/ml - 21,160z/Lin.yd

**DURABILITY:** 100.000 Martindale

**ENVIRONMENT:** STANDARD 100 by OEKO-TEX® / EU Ecolabel

**FIRE STANDARDS:** BS 5852 Crib 5  
EN 1021-1/2 / EN 13501-1 B-s1, d0



# FABRICS' SELECTIONS

TO CREATE YOUR CUSTOM GRID, HOFF AND NUBILO SOFAS, ARMCHAIRS, STOOLS - FOR LILY, PLEASE REFER TO FABRICS WITH \*

## CATEGORY 3

CAMIRA - OCEANIC | GABRIEL - SAVOY | KVADRAT - CLAY - SAHCO | KVADRAT  
- STEELCUT 2 | KVADRAT - STEELCUT TRIO 3 | KVADRAT - GALAXY | KVADRAT- ENCIRCLE\*



### 3C. KVADRAT - CLAY - SAHCO

**MATERIAL:** 76% linen, 21% cotton, 3% polyester  
*Width : 140cm - 55in*  
*Weight : 768g/ml - 27,09oz/Lin.yd*

**DURABILITY:** 45.000 Martindale  
**ENVIRONMENT:** GREENGUARD GOLD, HPD,  
**EPD FIRE STANDARDS:** BS 5852 source 0 / 1, EN 1021-1 / 2 With flame retardant treatment: BS 5852 source 5.

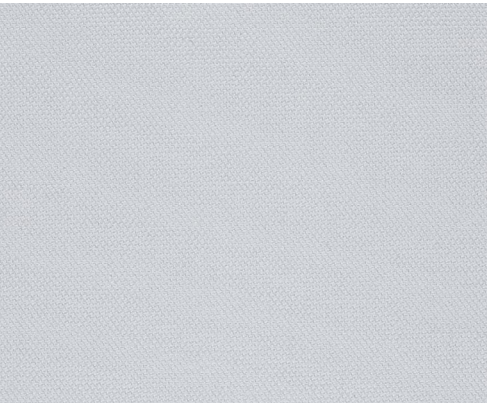

### 3D. KVADRAT - STEELCUT 2

**MATERIAL:** 90% new wool worsted  
10% nylon  
*Width : 175cm - 69in*  
*Weight : 825g/ml - 29,10oz/Lin.yd*

**DURABILITY:** 100.000 Martindale  
**ENVIRONMENT:** EU Ecolabel, Greenguard Gold, HPD, EPD  
**FIRE STANDARDS:** BS 5852 part 1 EN 1021-1/2  
BS 5852 crib 5 with treatment \*  
SN 198 898 5.3 with treatment \*

# FABRICS' SELECTIONS

TO CREATE YOUR CUSTOM GRID, HOFF AND NUBILO SOFAS, ARMCHAIRS, STOOLS - FOR LILY, PLEASE REFER TO FABRICS WITH \*

## CATEGORY 3

CAMIRA - OCEANIC | GABRIEL - SAVOY | KVADRAT - CLAY - SAHCO | KVADRAT  
- STEELCUT 2 | KVADRAT - STEELCUT TRIO 3 | KVADRAT - GALAXY | KVADRAT- ENCIRCLE

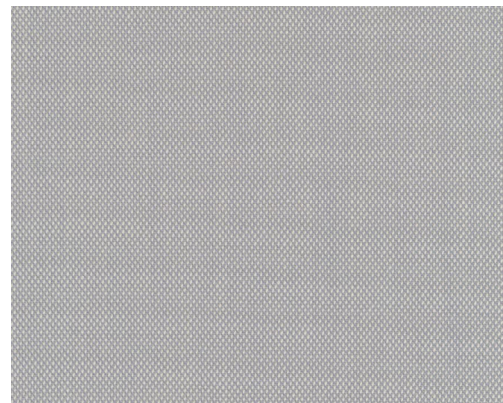
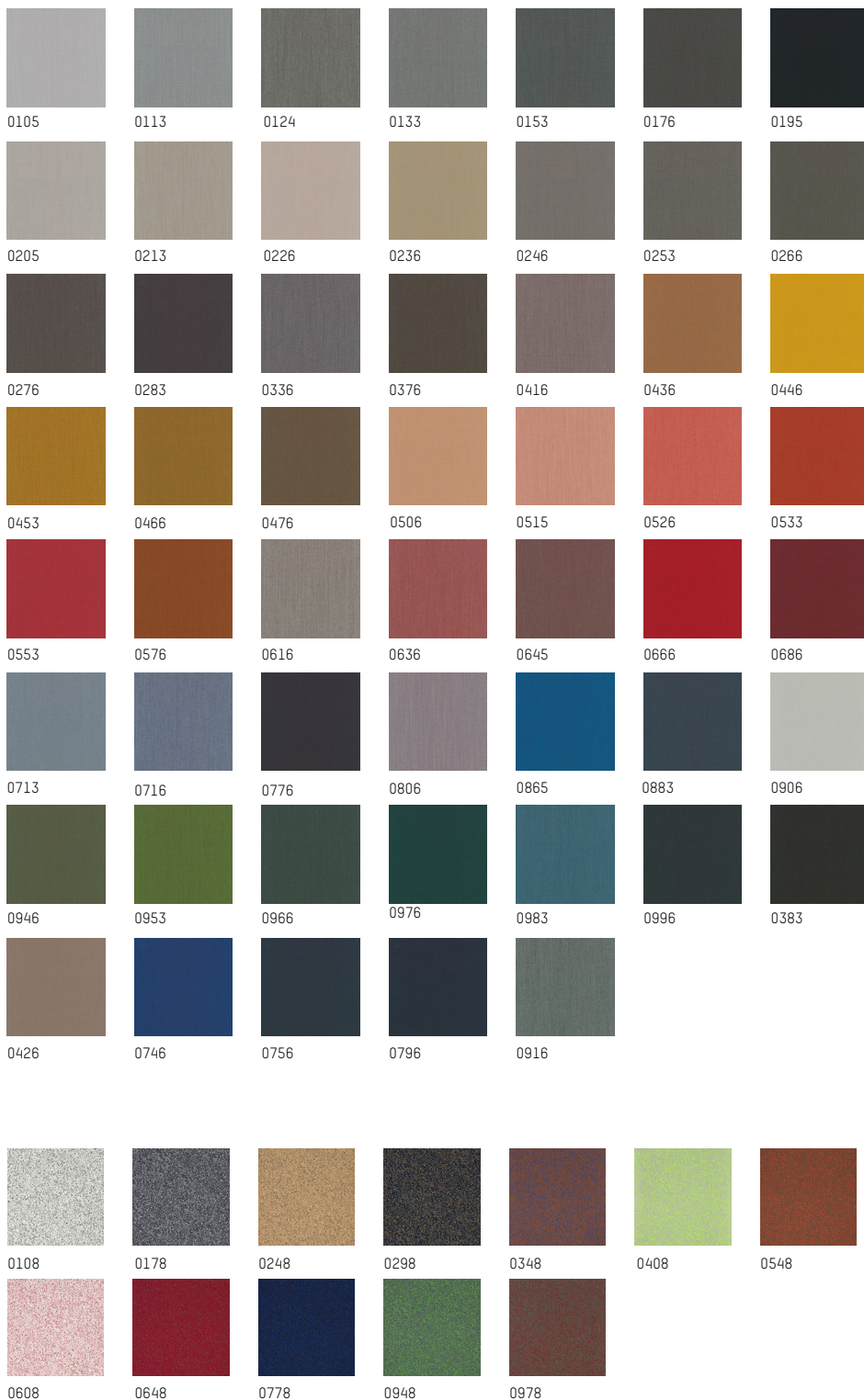

### 3E. KVADRAT - STEELCUT TRIO 3

**MATERIAL:** 90% new wool worsted 10% nylon  
Width : 140cm - 55in  
Weight : 770g/ml - 27,160z/Lin.yd

**DURABILITY:** 100.000 Martindale

**ENVIRONMENT:** EU Ecolabel, Greenguard Gold, HPD, EPD

**FIRE STANDARDS:** EN 1021-1/2  
BS 5852 part 1/ BS Crib 5  
With flame retardant treatment.

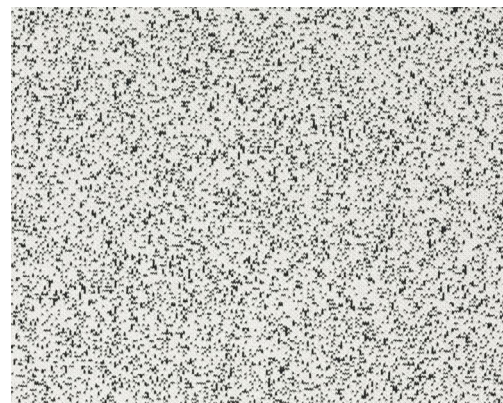

### 3F. KVADRAT - GALAXY

**MATERIAL:** 100% polyester FR  
Width : 175cm - 69in  
Weight : 760g/ml - 26,810z/Lin.yd

**DURABILITY:** 50.000 Martindale

**ENVIRONMENT:** Greenguard Gold, HPD, EPD  
**FIRE STANDARDS:** BS 5852 Crib 5, EN 1021-1/2



# FABRICS' SELECTIONS

TO CREATE YOUR CUSTOM GRID, HOFF AND NUBILO SOFAS, ARMCHAIRS, STOOLS - FOR LILY, PLEASE REFER TO FABRICS WITH \*

## CATEGORY 3

CAMIRA - OCEANIC | GABRIEL - SAVOY | KVADRAT - CLAY - SAHCO | KVADRAT  
- STEELCUT 2 | KVADRAT - STEELCUT TRIO 3 | KVADRAT - GALAXY | KVADRAT- ENCIRCLE

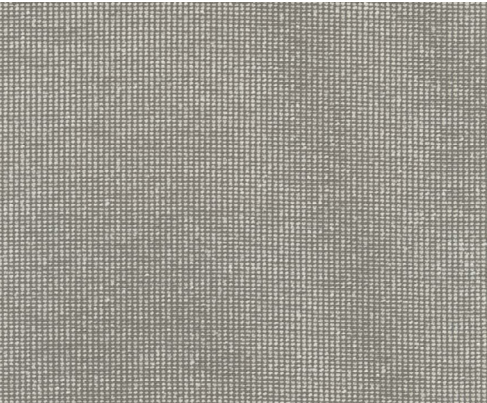

### 36. KVADRAT - ENCIRCLE\*

**MATERIAL:** 76% linen, 21% cotton, 3% polyester  
**Width:** 140cm - 55in  
**Weight:** 768g/ml - 27,090z/Lin.yd

**DURABILITY:** 45.000 Martindale  
**ENVIRONMENT:** GREENGUARD GOLD, HPD,  
**EPD FIRE STANDARDS:** BS 5852 source 0 / 1, EN 1021-1 / 2 With flame retardant treatment: BS 5852 source 5.



# FABRICS' SELECTIONS

TO CREATE YOUR CUSTOM GRID, HOFF AND NUBILO SOFAS, ARMCHAIRS, STOOLS - FOR LILY, PLEASE REFER TO FABRICS WITH \*

## CATEGORY 4

KVADRAT - MOSS | KVADRAT - FOSS | KVADRAT - COMFORT+ | KVADRAT - MOLLY 2



### 4A. KVADRAT - MOSS

**MATERIAL:** 100% post-consumer recycled polyester fr  
Width : 140cm - 55in  
Weight : 470g/ml - 16,60z/Lin.yd

**DURABILITY:** 60.000 Martindale  
**ENVIRONMENT:** STANDARD 100 by OEKO-TEX®  
**FIRE STANDARDS:** BS EN 1021 1&2 Cigarette and Match/ BS EN 1021-1 Cigarette BS 7176 Medium hazard/ BS 5852 Crib 5 BS 5852 Crib 5 / Call 117



### 4B. KVADRAT - FOSS

**MATERIAL:** 76% new wool worsted  
11% viscose 8% nylon 5% linen  
Width : 145cm - 57in  
Weight : 500g/ml - 17,640z/Lin.yd

**DURABILITY:** 100.000 Martindale  
**ENVIRONMENT:** EU Ecolabel, Greenguard Gold, HPD, EPD  
**FIRE STANDARDS:** BS 5852 part 1 EN 1021-1/2 BS 5852 crib 5 with treatment \*



# FABRICS' SELECTIONS

TO CREATE YOUR CUSTOM GRID, HOFF AND NUBILO SOFAS, ARMCHAIRS, STOOLS - FOR LILY, PLEASE REFER TO FABRICS WITH \*

## CATEGORY 4

KVADRAT - MOSS | KVADRAT - FOSS | KVADRAT - COMFORT+ | KVADRAT - MOLLY 2



### 4C. KVADRAT - COMFORT +

**MATERIAL:** 78% polyester/12% polyurethane incl. antistatic fibers and fire retardant fibers in the backside  
**Width:** 140cm - 55in  
**Weight:** 385g/ml - 13,580z/Lin.yd

**DURABILITY:** 150.000 Martindale  
**ENVIRONMENT:** STANDARD 100 by DEKO-TEX®  
**FIRE STANDARDS:** BS EN 1021 1&2 Cigarette and Match /BS EN 1021-1 Cigarette

00004	00005	00010	00018	00026	00028	00029
00033	00034	00035	00040	00049	00050	00280
01012	01043	01049	01065	01124	01147	01153
01160	01161	01163	01167	01414	01566	08384
08397	08402	08422	09055	09074	09075	09084
60002	60003	60004	60005	60008	60009	61002
61003	61013	61014	61015	61016	61018	62003
62004	62005	63001	63006	64001	64002	64003
64009	64012	64013	64014	65003	65012	66002
66004	66005	66008	66010	67001	67002	68000
68001	68003	68007	68008	68009	68010	68011

# FABRICS' SELECTIONS

TO CREATE YOUR CUSTOM GRID, HOFF AND NUBILO SOFAS, ARMCHAIRS, STOOLS - FOR LILY, PLEASE REFER TO FABRICS WITH \*

## CATEGORY 4

KVADRAT - MOSS | KVADRAT - FOSS | KVADRAT - COMFORT+ | KVADRAT - MOLLY 2



### 4D. KVADRAT - MOLLY 2

**MATERIAL:** 100% new wool worsted  
*Width : 140cm - 55in*  
*Weight : 610g/ml - 21,520z/Lin.yd*

**DURABILITY:** 75.000 Martindale  
**ENVIRONMENT:** EU Ecolabel, Greenguard Gold, HPD, Only natural color wool  
**FIRE STANDARDS:** BS 5852 part 1  
 EN 1021-½  
 BS 5852 crib 5 with treatment \*



## CATEGORY 5

VIDAR 4 - KVADRAT\* | SOVOS - LEATHER | KVADRAT - SAPHIRE



### 5A. VIDAR 4 - KVADRAT\*

**MATERIAL:** 94% new wool 6% nylon  
*Width : 140cm - 55in*  
*Weight : 765g/ml - 26,98 Oz/Lin.yd*

**DURABILITY:** : 100.000 Martindale  
**ENVIRONMENT:** EU Ecolabel, Greenguard Gold, HPD, EPD  
**FIRE STANDARDS:** BS 5852 part 1  
 EN 1021-½  
 BS 5852 crib 5 with treatment \*



# FABRICS' SELECTIONS

TO CREATE YOUR CUSTOM GRID, HOFF AND NUBILO SOFAS, ARMCHAIRS, STOOLS - FOR LILY, PLEASE REFER TO FABRICS WITH \*

## CATEGORY 5

VIDAR 4 - KVADRAT I SOVOS - LEATHER I KVADRAT - SAPHIRE



### 5B. SOVOS - LEATHER

**MATERIAL:** 76% linen, 21% cotton, 3% polyester  
*Width : 140cm - 55in*  
*Weight : 768g/ml - 27,090z/Lin.yd*

**DURABILITY:** 45.000 Martindale  
**ENVIRONMENT:** GREENGUARD GOLD, HPD,  
**EPD FIRE STANDARDS:** BS 5852 source 0 / 1, EN 1021-1 / 2 With flame retardant treatment: BS 5852 source 5.

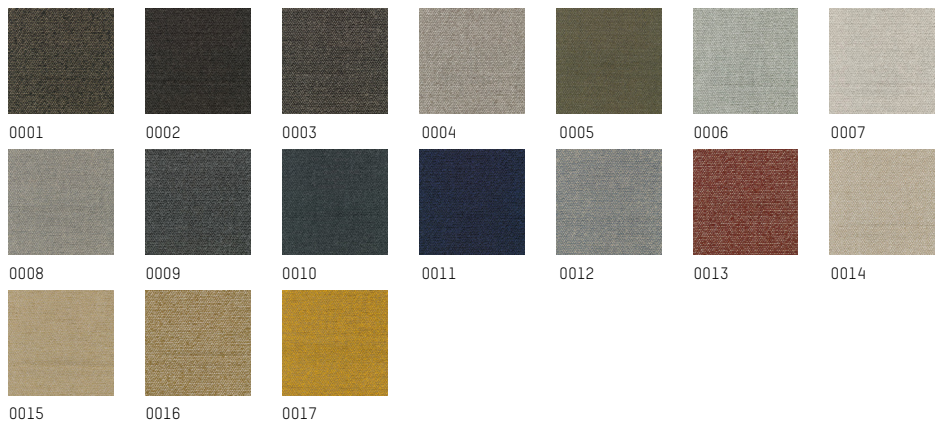
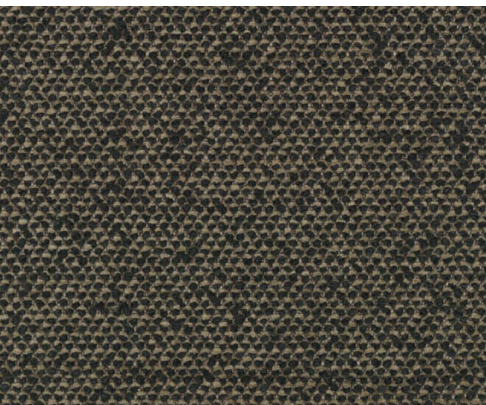

### 5C. KVADRAT - SAPHIRE

**MATERIAL:** 43% viscose 17% polyacrylic  
 15% new wool 9% cotton 8% polyester  
 8% linen  
*Width : 140cm - 55in*  
*Weight : 1010g/ml - 35,630z/Lin.yd*

**DURABILITY:** 44.000 Martindale  
**ENVIRONMENT:** Greenguard Gold, HPD EPD  
**FIRE STANDARDS:** : BS 5852 source 0 / 1 EN 1021-1 / 2 With flame retardant treatment: BS 5852 source 5

**OUTDOOR**







**WEEK - END**

STUDIO BRICHET ZIEGLER

2019

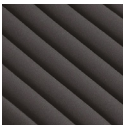

Anthracite



Pearl grey

**Cushions**

-

**MATERIALS**

Cover in polyester, Garnish foam in polyurethane

**COLORS**

Anthracite, Pearl grey

**ORIGIN**

France

**TECHNICAL SPECIFICATIONS**

Dryfeel foam  
Suitable for outdoor use.

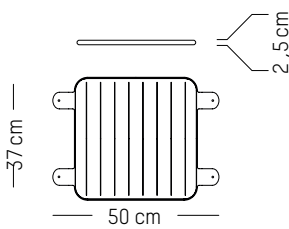

**Small**

-

**L:** 50 cm | 20 inch  
**W:** 37 cm | 15 inch  
**H:** 2,5 cm | 1 inch  
**Weight:** 0,4 kg | 0.8 lb

**PACKAGING :**

**L:** 53cm | 20.9 inch  
**W:** 53cm | 20.9 inch  
**Weight:** 0,6 kg | 1.3 lb

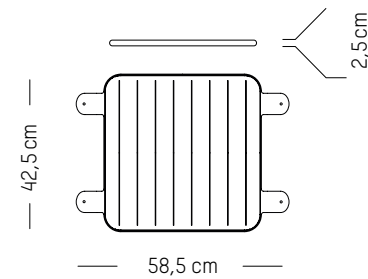

**Large**

-

**L:** 58,4 cm | 24 inch  
**W :** 45 cm | 18 inch  
**H:** 2,5 cm | 1 inch  
**Weight:** 0,4 kg | 0.8 lb

**PACKAGING :**

**L:** 53cm | 20.9 inch  
**W:** 53cm | 20.9 inch  
**Weight:** 0,6 kg | 1.3 lb

# WEEK-END

STUDIO BRICHET ZIEGLER

2017



Black



White



Blue



Burgundy



Blush



Terracotta



Jade green



Glass green



Yellow

## Chair, Bridge & Armchair

-

### MATERIALS

Aluminium, matte grained Anti UV powder coating for outdoor use

### COLORS

Black, White, Blue, Burgundy, Blush, Terracotta, Jade green, Glass green, Yellow

### ORIGIN

China

### TECHNICAL SPECIFICATIONS

Compliant with EN 581-1 ; EN581 -2 for Contract Use

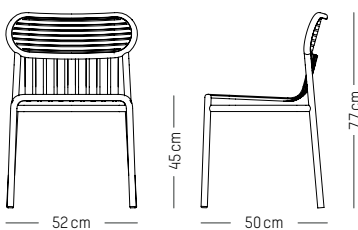

### Chair

-

**L:** 52 cm | 20.5 inch  
**W:** 50 cm | 19.7 inch  
**H:** 77 cm | 30.3 inch  
**H1:** 45 cm | 17.7 inch  
**Weight:** 3 kg | 6.6 lb

### PACKAGING (X2):

**L:** 60 cm | 23.6 inch  
**W:** 53 cm | 20.9 inch  
**H:** 98 cm | 38.6 inch  
**Weight:** 8 kg | 17.7 lb

Stackable

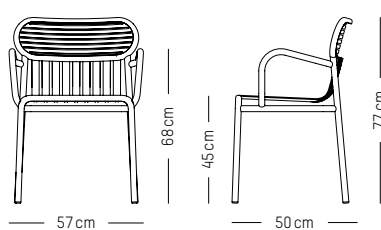

### Bridge

-

**L:** 57 cm | 22.4 inch  
**W:** 50 cm | 19.7 inch  
**H:** 77 cm | 30.3 inch  
**H1:** 45 cm | 17.7 inch  
**Weight:** 4 kg | 8.8 lb

### PACKAGING (X2) :

**L:** 60 cm | 23.6 inch  
**W:** 53 cm | 20.9 inch  
**H:** 98 cm | 38.6 inch  
**Weight:** 11,5 kg | 25.4 lb

Stackable

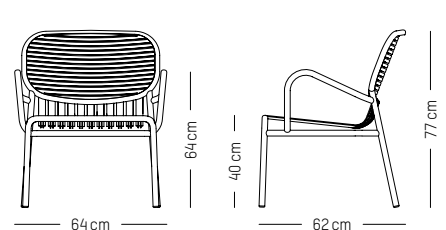

### Armchair

-

**L:** 66 cm | 26 inch  
**L:** 62 cm | 24.4 inch  
**H:** 77 cm | 30.3 inch (back)  
**H:** 40 cm | 15.7 inch (seat)  
**H:** 62 cm | 24.4 inch (armrests)  
**Weight:** 5kg | 11 lb

### PACKAGING (X2) :

**L:** 70 cm | 27.6 inch  
**W:** 70 cm | 27.6 inch  
**H:** 83 cm | 32.7 inch  
**Weight :** 15 kg | 33 lb

Stackable

# WEEK-END

STUDIO BRICHET ZIEGLER

2019



Black



White



Blue

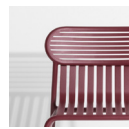

Burgundy



Blush



Terracotta



Jade green



Glass green



Yellow

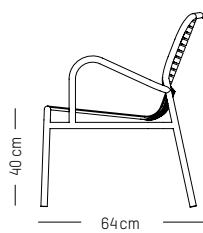
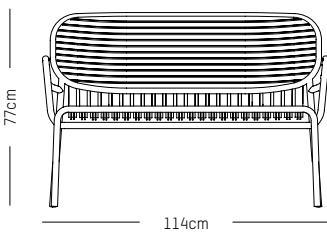

## 2 seater sofa

-

**L:** 113,5 cm | 44.5 inch

**W:** 64 cm | 24.2 inch

**H:** 78.5 cm | 31 inch (back)

**H:** 40 cm | 15.7 inch (seat)

**Weight:** 9 kg | 19.8 lb

### PACKAGING :

**L:** 70 cm | 27.6 inch

**W:** 120 cm | 47.2 inch

**H:** 83 cm | 32.7 inch

**Weight:** 12 kg | 26.5 lb

**Stackable**

## Sofa

-

### MATERIALS

Aluminium, matte grained Anti UV powder coating for outdoor use

### COLORS

Black, White, Blue, Burgundy, Blush, Terracotta, Jade green, Glass green, Yellow

### ORIGIN

China

### TECHNICAL SPECIFICATIONS

Compliant with EN 581-1 ; EN581 -2 for Contract Use



# WEEK - END

STUDIO BRICHET ZIEGLER

2017 & 2019



Black



White



Blue

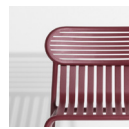

Burgundy



Blush



Terracotta



Jade green



Glass green



Yellow

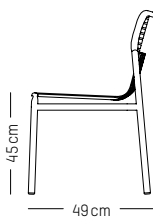
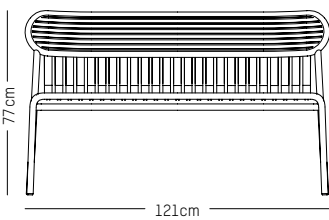

## Benches

-

### MATERIALS

Aluminium, matte grained Anti UV powder coating for outdoor use

### COLORS

Black, White, Blue, Burgundy, Blush, Terracotta, Jade green, Glass green, Yellow

### ORIGIN

China

### TECHNICAL SPECIFICATIONS

Compliant with EN 581-1 ; EN581 -2 for Contract Use

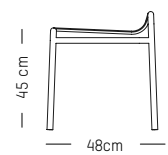
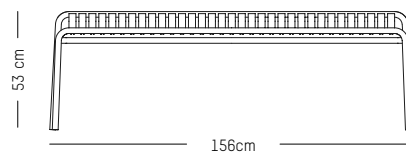

## Bench

-

**L:** 121 cm | 47.7 inch

**W:** 49 cm | 19.3 inch

**H:** 77 cm | 30.3 inch (back)

**H:** 40 cm | 15.7 inch (seat)

**Weight:** 11 kg | 24.2 lb

### PACKAGING :

**L:** 130 cm | 51.2 inch

**W:** 55 cm | 21.6 inch

**H:** 83 cm | 32.7 inch

**Weight:** 14 kg | 30.9 lb

**Stackable**

## Bench without back

-

**L:** 156 cm | 61.4inch

**W:** 50 cm | 19.7 inch

**H:** 45 cm | 15.8 inch (seat)

**Weight:** 8 kg | 17.6 lb

### PACKAGING :

**L:** 160 cm | 63 inch

**W:** 55 cm | 21.6 inch

**H:** 83 cm | 32.7 inch

**Weight:** 11 kg | 24.3 lb

**Stackable**

# WEEK - END

STUDIO BRICHET ZIEGLER

2017 & 2019



Black



White



Blue



Burgundy



Blush



Terracotta



Jade green



Glass green



Yellow

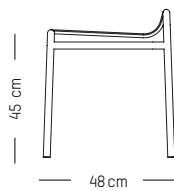
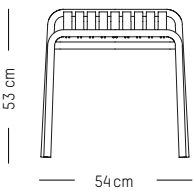

## Stool

-

**L:** 53,3 cm | 21 inch  
**W:** 58 cm | 22.8 inch  
**H:** 53 cm | 20.9 inch  
**H (seat):** 45 cm | 18 inch  
**Weight:** 3 kg | 6.6 lb

### PACKAGING :

**L:** 57 cm | 22.4 inch  
**W:** 61 cm | 24 inch  
**H:** 56 cm | 22 inch  
**Weight:** 5 kg | 11 lb

**Stackable**

## Stools

-

### MATERIALS

Aluminium, matte grained Anti UV powder coating for outdoor use

### COLORS

Black, White, Blue, Burgundy, Blush, Terracotta, Jade green, Glass green, Yellow

### ORIGIN

China

### TECHNICAL SPECIFICATIONS

Compliant with EN 581-1 ; EN581 -2 for Contract Use

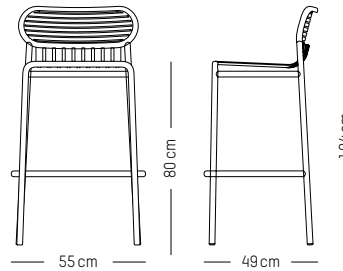

## Bar stool

-

**L:** 49 cm | 19.3 inch  
**W:** 55 cm | 19.3 inch  
**H:** 104cm | 50.9 inch  
**H (seat):** 80 cm | 32 inch  
**Weight:** 5,6 kg | 12.3 lb

### PACKAGING :

**L:** 53 cm | 20.9 inch  
**W:** 58 cm | 22.8 inch  
**H:** 110 cm | 43.3 inch  
**Weight:** 8 kg | 17.7 lb

**WEEK - END**

STUDIO BRICHET ZIEGLER

2019

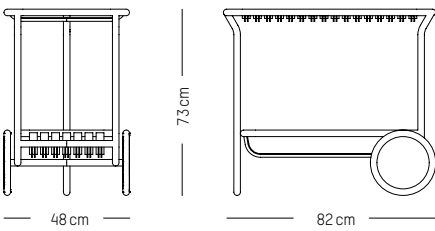

**Trolley**

**MATERIALS**

Aluminium, matte grained Anti UV powder coating for outdoor use

**COLORS**

Black, White, Blue, Burgundy, Blush, Terracotta, Jade green, Glass green, Yellow

**ORIGIN**

China

**Trolley**

**W:** 48 cm | 19 inch  
**L:** 82 cm | 32.3 inch  
**H:** 73 cm | 29 inch  
**Weight:** 9 kg | 20 lb

**PACKAGING :**

**L:** 85 cm | 33.5 inch  
**W:** 51 cm | 20.1 inch  
**H:** 76 cm | 29.3 inch  
**Weight :** 12 kg | 26.5 lb

**WEEK - END**

STUDIO BRICHET ZIEGLER

2017 & 2019

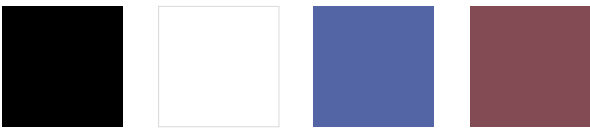

Black

White

Blue

Burgundy



Blush

Terracotta

Jade green

Glass green

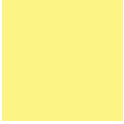

Yellow

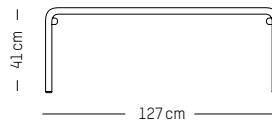
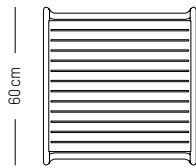
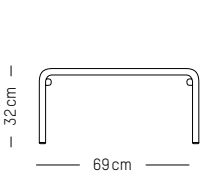

**Coffee table**

-

**W:** 60 cm | 23.6 inch

**L:** 69 cm | 27.2 inch

**H:** 32 cm | 12.6 inch

**Weight:** 4 kg | 8.8 lb

**PACKAGING :**

**L:** 72 cm | 28.3 inch

**W:** 72 cm | 28.3 inch

**H:** 35 cm | 13.8 inch

**Weight :** 5 kg | 11 lb

**Long coffee table**

-

**W:** 127 cm | 50 inch

**L:** 51 cm | 20 inch

**H:** 41 cm | 16.1 inch

**Weight:** 5 kg | 11 lb

**PACKAGING :**

**L:** 130 cm | 51.2 inch

**W:** 58 cm | 22.8 inch

**H:** 45 cm | 17.7 inch

**Weight:** 6 kg | 13.6 lb

**WEEK - END**

STUDIO BRICHET ZIEGLER

2017



**Dining tables**

-

**MATERIALS**

Aluminium, matte grained Anti UV powder coating for outdoor use

**COLORS**

Black, White, Blue, Burgundy, Blush, Terracotta, Jade green, Glass green, Yellow

**ORIGIN**

China



Black

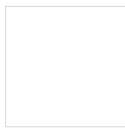

White



Blue



Burgundy



Blush



Terracotta



Jade green



Glass green



Yellow

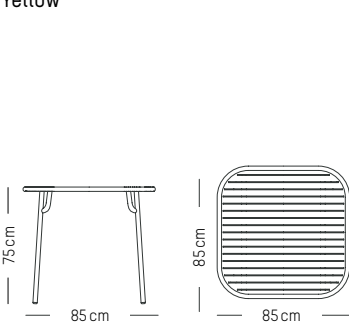

**Square table**

-

**L:** 85 cm | 33.5 inch  
**W:** 85 cm | 33.5 inch  
**H:** 75 cm | 29.5 inch  
**Weight:** 12 kg | 26.5 lb

**PACKAGING :**

**packaging tabletop**  
**L:** 86 cm | 33.9 inch  
**W:** 86 cm | 33.9 inch  
**H:** 5 cm | 2 inch  
**Weight:** 10 kg | 22 lb

**packaging legs (x2)**  
**L:** 19 cm | 7.5 inch  
**W:** 19 cm | 7.5 inch  
**H:** 80 cm | 31.5 inch  
**Weight:** 4 kg | 8.9 lb

**Assembly**

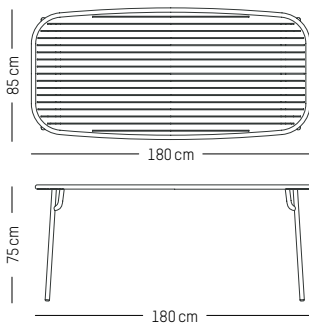

**Rectangular table medium**

-

**W:** 85 cm | 33.5 inch  
**L:** 180 cm | 70.9 inch  
**H:** 75 cm | 29.5 inch  
**Weight:** 22,3 kg | 49.2 lb

**PACKAGING :**

**packaging table top**  
**L:** 182 cm | 71.7 inch  
**W:** 88 cm | 34.6 inch  
**H:** 5 cm | 2 inch  
**Weight:** 22 kg | 48.5 lb

**packaging legs (x2)**  
**L:** 19 cm | 7.5 inch  
**W:** 19 cm | 7.5 inch  
**H:** 80 cm | 31.5 inch  
**Weight:** 4 kg | 8.9 lb

**Assembly**

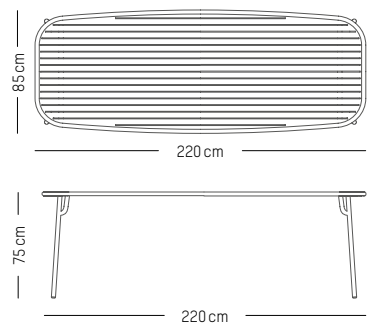

**Rectangular table large**

-

**W:** 85 cm | 33.5 inch  
**L:** 220 cm | 86.6 inch  
**H:** 75 cm | 29.5 inch  
**Weight:** 27 kg | 59.5 lb

**PACKAGING :**

**packaging table top**  
**L:** 222 cm | 87.4 inch  
**W:** 88 cm | 34.6 inch  
**H:** 5 cm | 2 inch  
**Weight:** 27 kg | 59.5 lb

**packaging legs (x2)**  
**L:** 19 cm | 7.5 inch  
**W:** 19 cm | 7.5 inch  
**H:** 80 cm | 31.5 inch  
**Weight:** 4 kg | 8.9 lb

**Assembly**

**WEEK - END**

STUDIO BRICHET ZIEGLER

2019

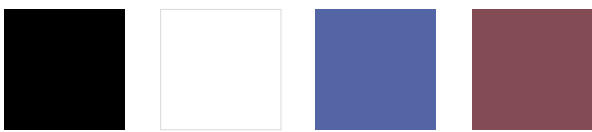

Black White Blue Burgundy



Blush Terracotta Jade green Glass green



Yellow

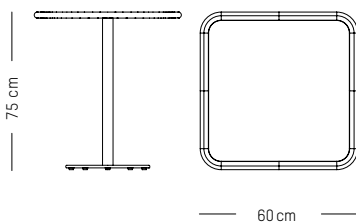

**Square bistro table**

L: 60 cm | 27.5 inch  
W: 60 cm | 27.5 inch  
H: 75 cm | 29.5 inch  
Weight: 11 kg | 24.2 lb

**PACKAGING :**

L: 72 cm | 28.3 inch  
W: 72 cm | 28.3 inch  
H: 78 cm | 30.7 inch  
Weight: 14 kg | 30.9 lb

**Assembly**

**Bistro tables**

**MATERIALS**

Aluminium, matte grained Anti UV powder coating for outdoor use

**COLORS**

Black, White, Blue, Burgundy, Blush, Terracotta, Jade green, Glass green, Yellow

**ORIGIN**

China

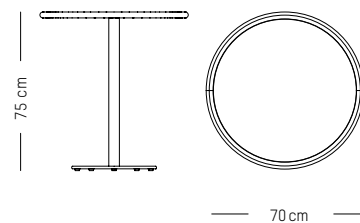

**Round bistro table**

Ø: 70 cm | 23.6 inch  
L: 70 cm | 23.6 inch  
H: 75 cm | 29.5 inch  
Weight: 10 kg | 22 lb

**PACKAGING :**

L: 73 cm | 29 inch  
W: 73 cm | 29 inch  
H: 78 cm | 30.7 inch  
Weight: 12 kg | 26.5 lb

**Assembly**

**WEEK - END**

STUDIO BRICHET ZIEGLER

2019



Black

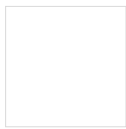

White



Blue



Burgundy



Blush



Terracotta



Jade green



Glass green



Yellow

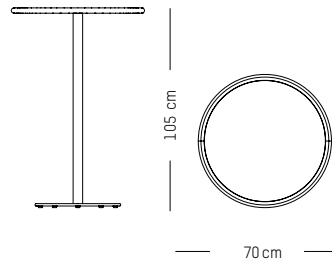
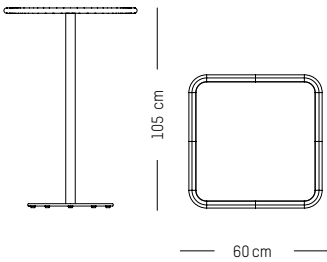

**High table square**

-

**L:** 60 cm | 27.5 inch  
**W:** 60cm | 27.5 inch  
**H:** 105 cm | 41.3 inch  
**Weight:** 13 kg | 29 lb

**PACKAGING :**

**L:** 72 cm | 28.3 inch  
**W:** 72 cm | 28.3 inch  
**H:** 108 cm | 42.5 inch  
**Weight:** 15 kg | 33 lb

**Assembly**

**High tables**

-

**MATERIALS**

Aluminium, matte grained Anti UV powder coating for outdoor use

**COLORS**

Black, White, Blue, Burgundy, Blush, Terracotta, Jade green, Glass green, Yellow

**ORIGIN**

China



**WEEK - END**

STUDIO BRICHET ZIEGLER

2017

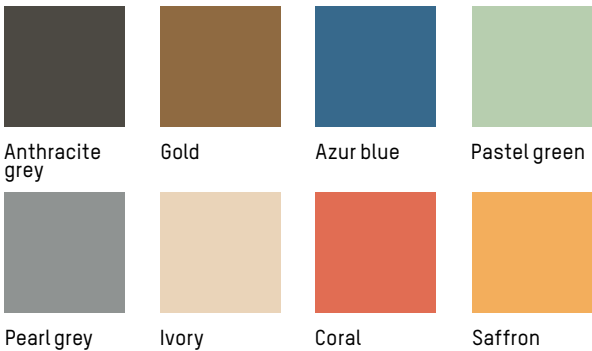

FOR CONTRACT PROJECT WITH MINIMUM QUANTITY

**Chair, Bridge & Armchair**

**MATERIALS**

Aluminium, matte grained Anti UV powder coating for outdoor use

**COLOURS**

Anthracite grey, Gold, Azur blue, Pastel green, Pearl grey, Ivory, Coral, Saffron

**ORIGIN**

China

**TECHNICAL SPECIFICATIONS**

Compliant with EN 581-1 ; EN581 -2 for Contract Use

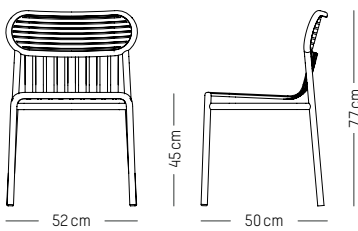

**Chair**

L: 52 cm | 20.5 inch  
W: 50 cm | 19.7 inch  
H: 77 cm | 30.3 inch  
H1: 45 cm | 17.7 inch  
Weight: 3 kg | 6.6 lb

**PACKAGING (X2):**

L: 60 cm | 23.6 inch  
W: 53 cm | 20.9 inch  
H: 98 cm | 38.6 inch  
Weight: 8 kg | 17.7 lb

Stackable

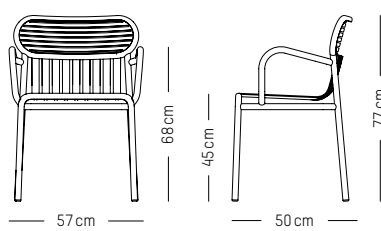

**Bridge**

L: 57 cm | 22.4 inch  
W: 50 cm | 19.7 inch  
H: 77 cm | 30.3 inch  
H1: 45 cm | 17.7 inch  
Weight: 4 kg | 8.8 lb

**PACKAGING (X2) :**

L: 60 cm | 23.6 inch  
W: 53 cm | 20.9 inch  
H: 98 cm | 38.6 inch  
Weight: 11,5 kg | 25.4 lb

Stackable

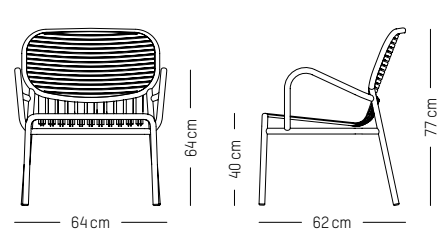

**Armchair**

L: 66 cm | 26 inch  
L: 62 cm | 24.4 inch  
H: 77 cm | 30.3 inch (back)  
H: 40 cm | 15.7 inch (seat)  
H: 62 cm | 24.4 inch (armrests)  
Weight: 5kg | 11 lb

**PACKAGING (X2) :**

L: 70 cm | 27.6 inch  
W: 70 cm | 27.6 inch  
H: 83 cm | 32.7 inch  
Weight : 15 kg | 33 lb

Stackable



**WEEK - END**

STUDIO BRICHET ZIEGLER

2019

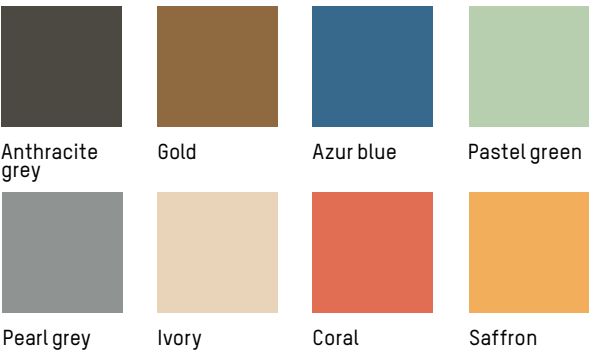

FOR CONTRACT PROJECT WITH MINIMUM QUANTITY

**Sofa**

-

**MATERIALS**

Aluminium, matte grained Anti UV powder coating for outdoor use

**COLOURS**

Anthracite grey, Gold, Azur blue, Pastel green, Pearl grey, Ivory, Coral, Saffron

**ORIGIN**

China

**TECHNICAL SPECIFICATIONS**

Compliant with EN 581-1 ; EN581 -2 for Contract Use

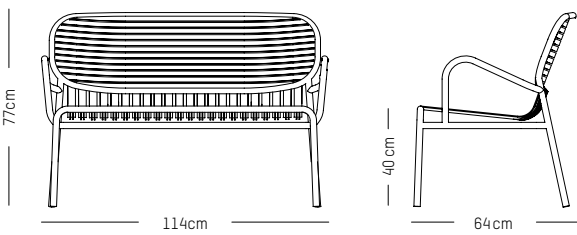

**2 seater sofa**

-

**L:** 113,5 cm | 44.5 inch

**W:** 64 cm | 24.2 inch

**H:** 78.5 cm | 31 inch (back)

**H:** 40 cm | 15.7 inch (seat)

**Weight:** 9 kg | 19.8 lb

**PACKAGING :**

**L:** 70 cm | 27.6 inch

**W:** 120 cm | 47.2 inch

**H:** 83 cm | 32.7 inch

**Weight:** 12 kg | 26.5 lb

**Stackable**

**WEEK - END**

STUDIO BRICHET ZIEGLER

2017 & 2019

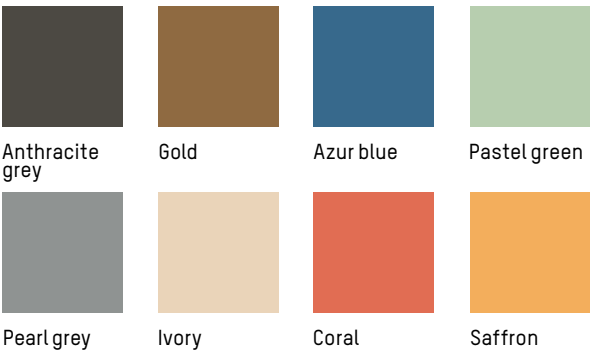

FOR CONTRACT PROJECT WITH MINIMUM QUANTITY

**Benches**

-

**MATERIALS**

Aluminium, matte grained Anti UV powder coating for outdoor use

**COLOURS**

Anthracite grey, Gold, Azur blue, Pastel green, Pearl grey, Ivory, Coral, Saffron

**ORIGIN**

China

**TECHNICAL SPECIFICATIONS**

Compliant with EN 581-1 ; EN581 -2 for Contract Use

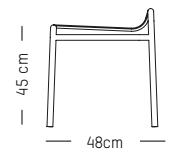
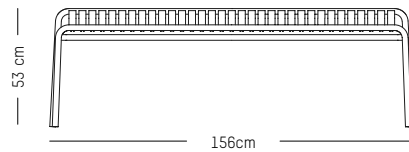
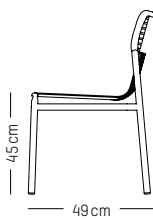
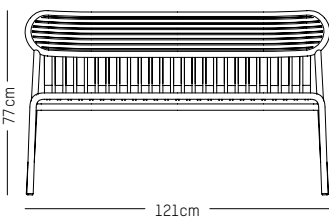

**Bench**

-

**L:** 121 cm | 47.7 inch  
**W:** 49 cm | 19.3 inch  
**H:** 77 cm | 30.3 inch (back)  
**H:** 40 cm | 15.7 inch (seat)  
**Weight:** 11 kg | 24.2 lb

**PACKAGING :**

**L:** 130 cm | 51.2 inch  
**W:** 55 cm | 21.6 inch  
**H:** 83 cm | 32.7 inch  
**Weight:** 14 kg | 30.9 lb

**Stackable**

**Bench without back**

-

**L:** 156 cm | 61.4inch  
**W:** 50 cm | 19.7 inch  
**H:** 45 cm | 15.8 inch (seat)  
**Weight:** 8 kg | 17.6 lb

**PACKAGING :**

**L:** 160 cm | 63 inch  
**W:** 55 cm | 21.6 inch  
**H:** 83 cm | 32.7 inch  
**Weight:** 11 kg | 24.3 lb

**Stackable**

## WEEK - END

STUDIO BRICHET ZIEGLER

2017 & 2019



Anthracite grey



Gold



Azur blue



Pastel green



Pearl grey



Ivory



Coral



Saffron

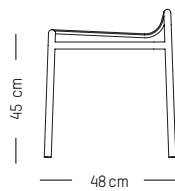
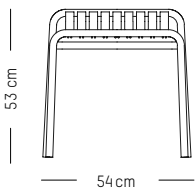

### Stool

-

**L:** 53,3 cm | 21 inch  
**W:** 58 cm | 22.8 inch  
**H:** 53 cm | 20.9 inch  
**H (seat):** 45 cm | 18 inch  
**Weight:** 3 kg | 6.6 lb

#### PACKAGING :

**L:** 57 cm | 22.4 inch  
**W:** 61 cm | 24 inch  
**H:** 56 cm | 22 inch  
**Weight:** 5 kg | 11 lb

**Stackable**

FOR CONTRACT PROJECT WITH MINIMUM QUANTITY

### Stools

-

#### MATERIALS

Aluminium, matte grained Anti UV powder coating for outdoor use

#### COLOURS

Anthracite grey, Gold, Azur blue, Pastel green, Pearl grey, Ivory, Coral, Saffron

#### ORIGIN

China

#### TECHNICAL SPECIFICATIONS

Compliant with EN 581-1 ; EN581 -2 for Contract Use

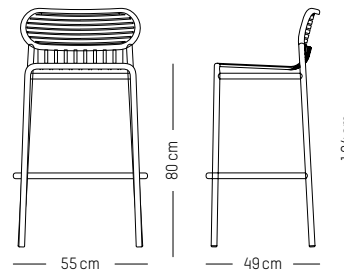

### Bar stool

-

**L:** 49 cm | 19.3 inch  
**W:** 55 cm | 19.3 inch  
**H:** 104cm | 50.9 inch  
**H (seat):** 80 cm | 32 inch  
**Weight:** 5,6 kg | 12.3 lb

#### PACKAGING :

**L:** 53 cm | 20.9 inch  
**W:** 58 cm | 22.8 inch  
**H:** 110 cm | 43.3 inch  
**Weight:** 8 kg | 17.7 lb

**WEEK - END**

STUDIO BRICHET ZIEGLER

2019

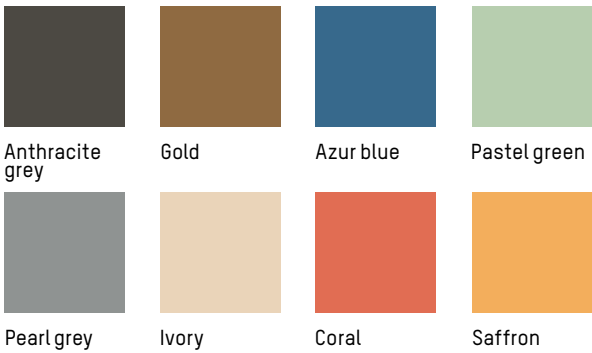

FOR CONTRACT PROJECT WITH MINIMUM QUANTITY

**Trolley**

-

**MATERIALS**

Aluminium, matte grained Anti UV powder coating for outdoor use

**COLOURS**

Anthracite grey, Gold, Azur blue, Pastel green, Pearl grey, Ivory, Coral, Saffron

**ORIGIN**

China

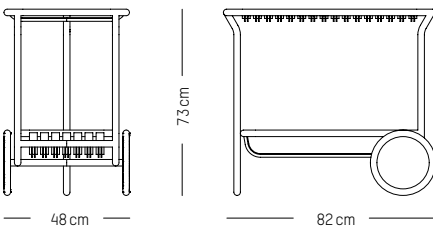

**Trolley**

-

**W:** 48 cm | 19 inch  
**L:** 82 cm | 32.3 inch  
**H:** 73 cm | 29 inch  
**Weight:** 9 kg | 20 lb

**PACKAGING :**

**L:** 85 cm | 33.5 inch  
**W:** 51 cm | 20.1 inch  
**H:** 76 cm | 29.3 inch  
**Weight :** 12 kg | 26.5 lb



# WEEK-END

STUDIO BRICHET ZIEGLER

2017 & 2019

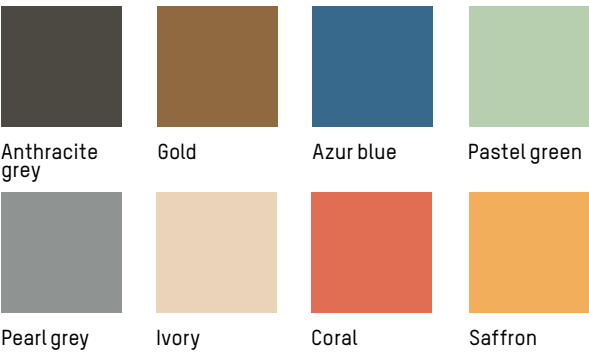

FOR CONTRACT PROJECT WITH MINIMUM QUANTITY

## Coffee tables

### MATERIALS

Aluminium, matte grained Anti UV powder coating for outdoor use

### COLOURS

Anthracite grey, Gold, Azur blue, Pastel green, Pearl grey, Ivory, Coral, Saffron

### ORIGIN

China

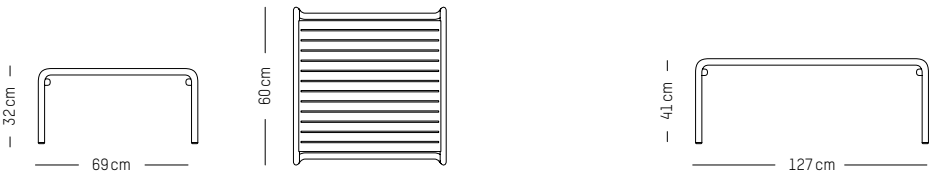

## Coffee table

**W:** 60 cm | 23.6 inch  
**L:** 69 cm | 27.2 inch  
**H:** 32 cm | 12.6 inch  
**Weight:** 4 kg | 8.8 lb

### PACKAGING :

**L:** 72 cm | 28.3 inch  
**W:** 72 cm | 28.3 inch  
**H:** 35 cm | 13.8 inch  
**Weight :** 5 kg | 11 lb

## Long coffee table

**W:** 127 cm | 50 inch  
**L:** 51 cm | 20 inch  
**H:** 41 cm | 16.1 inch  
**Weight:** 5 kg | 11 lb

### PACKAGING :

**L:** 130 cm | 51.2 inch  
**W:** 58 cm | 22.8 inch  
**H:** 45 cm | 17.7 inch  
**Weight:** 6 kg | 13.6 lb

*STUDIO BRICHET ZIEGLER*

**2017**



**Dining tables**

**MATERIALS**

Aluminium, matte grained Anti UV powder coating for outdoor use

**COLOURS**

Anthracite grey, Gold, Azur blue, Pastel green, Pearl grey, Ivory, Coral, Saffron

**ORIGIN**

China

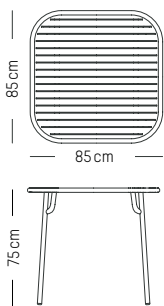
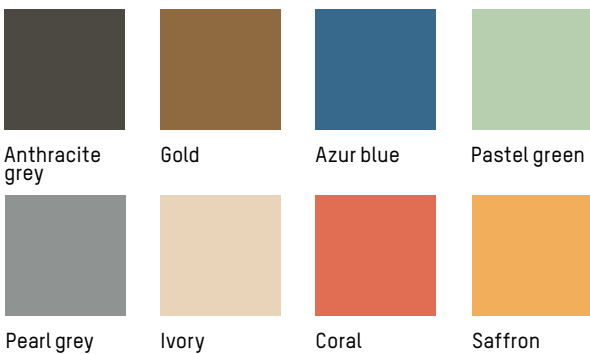

**Square table**

**L:** 85 cm | 33.5 inch  
**W:** 85 cm | 33.5 inch  
**H:** 75 cm | 29.5 inch  
**Weight:** 12 kg | 26.5 lb

**PACKAGING :**

**packaging tabletop**  
**L:** 86 cm | 33.9 inch  
**W:** 86 cm | 33.9 inch  
**H:** 5 cm | 2 inch  
**Weight:** 10 kg | 22 lb

**packaging legs (x2)**  
**L:** 19 cm | 7.5 inch  
**W:** 19 cm | 7.5 inch  
**H:** 80 cm | 31.5 inch  
**Weight:** 4 kg | 8.9 lb

**Assembly**

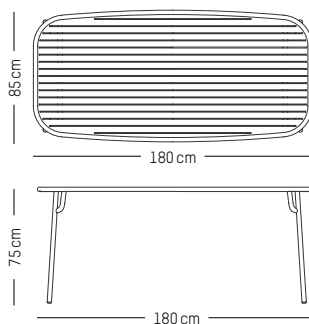

**Rectangular table medium**

**W:** 85 cm | 33.5 inch  
**L:** 180 cm | 70.9 inch  
**H:** 75 cm | 29.5 inch  
**Weight:** 22,3 kg | 49.2 lb

**PACKAGING :**

**packaging table top**  
**L:** 182 cm | 71.7 inch  
**W:** 88 cm | 34.6 inch  
**H:** 5 cm | 2 inch  
**Weight:** 22 kg | 48.5 lb

**packaging legs (x2)**  
**L:** 19 cm | 7.5 inch  
**W:** 19 cm | 7.5 inch  
**H:** 80 cm | 31.5 inch  
**Weight:** 4 kg | 8.9 lb

**Assembly**

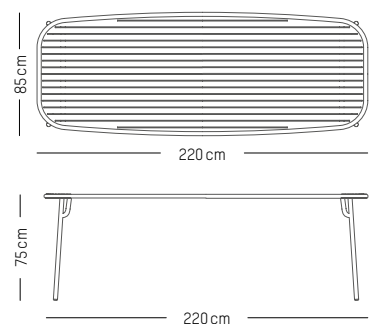

**Rectangular table large**

**W:** 85 cm | 33.5 inch  
**L:** 220 cm | 86.6 inch  
**H:** 75 cm | 29.5 inch  
**Weight:** 27 kg | 59.5 lb

**PACKAGING :**

**packaging table top**  
**L:** 222 cm | 87.4 inch  
**W:** 88 cm | 34.6 inch  
**H:** 5 cm | 2 inch  
**Weight:** 27 kg | 59.5 lb

**packaging legs (x2)**  
**L:** 19 cm | 7.5 inch  
**W:** 19 cm | 7.5 inch  
**H:** 80 cm | 31.5 inch  
**Weight:** 4 kg | 8.9 lb

**Assembly**

**WEEK - END**

STUDIO BRICHET ZIEGLER

2019

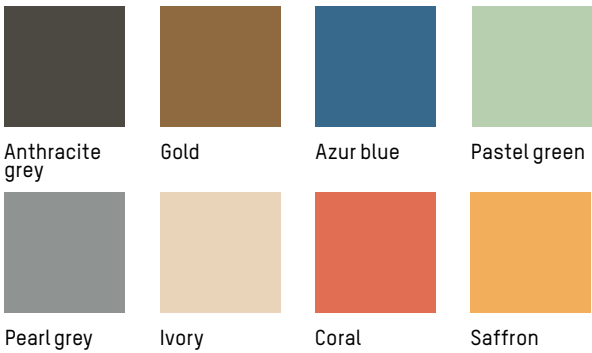

FOR CONTRACT PROJECT WITH MINIMUM QUANTITY

**Bistro tables**

-

**MATERIALS**

Aluminium, matte grained Anti UV powder coating for outdoor use

**COLOURS**

Anthracite grey, Gold, Azur blue, Pastel green, Pearl grey, Ivory, Coral, Saffron

**ORIGIN**

China

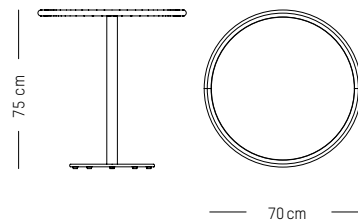
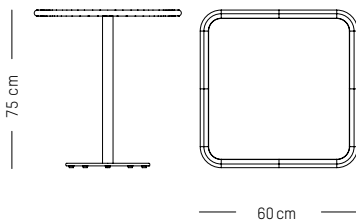

**Square bistro table**

-

**L:** 60 cm | 27.5 inch  
**W:** 60cm | 27.5 inch  
**H:** 75 cm | 29.5 inch  
**Weight:** 11 kg | 24.2 lb

**PACKAGING :**

**L:** 72 cm | 28.3 inch  
**W:** 72 cm | 28.3 inch  
**H:** 78 cm | 30.7 inch  
**Weight:** 14 kg | 30.9 lb

**Assembly**

**Round bistro table**

-

**Ø:** 70 cm | 23.6 inch  
**L:** 70 cm | 23.6 inch  
**H:** 75 cm | 29.5 inch  
**Weight:** 10 kg | 22 lb

**PACKAGING :**

**L:** 73 cm | 29 inch  
**W:** 73 cm | 29 inch  
**H:** 78 cm | 30.7 inch  
**Weight:** 12 kg | 26.5 lb

**Assembly**

**WEEK - END**

STUDIO BRICHET ZIEGLER

2019

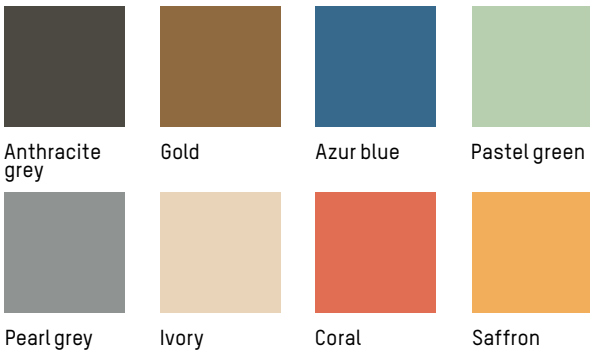

FOR CONTRACT PROJECT WITH MINIMUM QUANTITY

**High tables**

-

**MATERIALS**

Aluminium, matte grained Anti UV powder coating for outdoor use

**COLOURS**

Anthracite grey, Gold, Azur blue, Pastel green, Pearl grey, Ivory, Coral, Saffron

**ORIGIN**

China

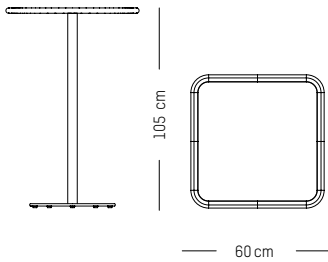

**High table square**

-

**L:** 60 cm | 27.5 inch  
**W:** 60cm | 27.5 inch  
**H:** 105 cm | 41.3 inch  
**Weight:** 13 kg | 29 lb

**PACKAGING :**

**L:** 72 cm | 28.3 inch  
**W:** 72 cm | 28.3 inch  
**H:** 108 cm | 42.5 inch  
**Weight:** 15 kg | 33 lb

**Assembly**

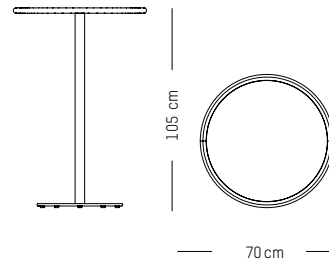

**High table round**

-

**Ø:** 70 cm | 23.6 inch  
**L:** 70 cm | 23.6 inch  
**H:** 105 cm | 41.3 inch  
**Weight:** 12 kg | 26.4 lb

**PACKAGING :**

**L:** 73 cm | 29 inch  
**W:** 73 cm | 29 inch  
**H:** 108 cm | 42.5 inch  
**Weight:** 14 kg | 30.9 lb

**Assembly**

**DECORATION**





# BUBBLE

VAULOT & DYÈVRE

2013

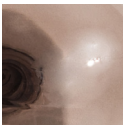

Grey

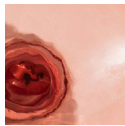

Coral



Yellow

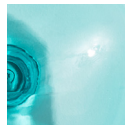

Blue

## Hooks

-

### MATERIALS

Hook in blown glass, Fixing system in steel

### COLORS

Grey, Coral, Yellow, Blue

### ORIGIN

Europe

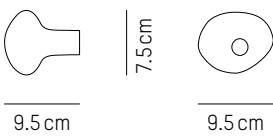

## Small

-

**L:** 9,5 cm | 3.7 inch

**W:** 9,5 cm | 3.7 inch

**H:** 7,5 cm | 2.3 inch

**Weight:** 0,25 kg | 0.5 lb

### PACKAGING :

**L:** 12 cm | 5 inch

**W:** 12 cm | 5 inch

**H:** 16 cm | 6.3 inch

**Weight:** 0,5 kg | 1.1 lb

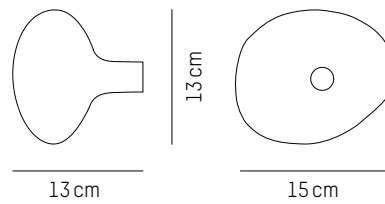

## Large

-

**L:** 13cm | 5.12 inch

**W:** 13 cm | 5.12 inch

**H:** 15 cm | 5.9 inch

**Weight:** 0,8 kg | 1.8 lb

### PACKAGING :

**L:** 16,5 cm | 6.5 inch

**W:** 16,5 cm | 6.5 inch

**H:** 22,5 cm | 8.9 inch

**Weight:** 1 kg | 2.2 lb

# DONUT

PIA CHEVALIER

2022



Vanilla



Bubble Gum



Cherry



Blueberry



Lemon



Pistachio

## Tableware

-

### MATERIALS

Earthenware, white body and enamel.

### COLORS

Espresso cup and mug: Vanilla, Bubble Gum, Cherry, Blueberry, Lemon and Pistachio

L mug: Vanilla and Pistachio

### ORIGIN

Europe

### TECHNICAL SPECIFICATIONS

Food compliance European tests :Lead and cadmium tests

+ Aluminium, Cobalt and Arsenic tests

- (EC) 1935/2004/EC

- (EC) No 2023/2006

Food compliance American tests : Lead and cadmium tests

- FDA (Food and Drug administration) Title 21 Code of Federal Regulations (CFR, 2011 Edition)

FOOD SAFE

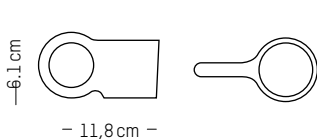

### Espresso cup (set of 2 pcs)

-

Ø : 6,1cm | 2.5 inch

H: 5,6 cm | 2.4 inch

Weight: 0,15 kg | 0.2 lb

**PACKAGING (Cash&Carry = 1 set)**

L: 17 cm | 6.7 inch

W: 15 cm | 6 inch

H: 9 cm | 3.6 inch

Weight: 0,4 kg | 0.9 lb

**Master Pack (2 cash&carry)**

L: 31 cm | 12.2 inch

W: 19 cm | 7.5 inch

H: 4 cm | 1.6 inch

Weight: 1 kg | 2.2 lb

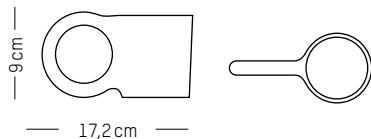

### M Mug

-

Ø : 8,3 cm | 4 inch

H: 9 cm | 3.6 inch

Weight : 0,4 kg | 0.9 lb

**PACKAGING (Cash&Carry = 1 M)**

L: 22 cm | 8.7 inch

W: 12 cm | 4.8 inch

H: 13 cm | 5.2 inch

Weight: 0,4 kg | 0.9 lb

**Master Pack (2 cash&carry)**

L: 25 cm | 9.9 inch

W: 25 cm | 9.9 inch

H: 14 cm | 5.6 inch

Weight: 1 kg | 2.2 lb

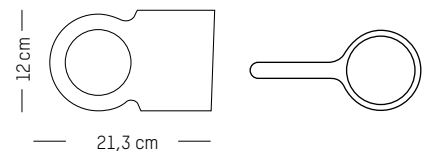

### L Mug

-

Ø : 9,2 cm | 4 inch

H: 12 cm | 3.6 inch

Weight : 0,4 kg | 0.9 lb

**PACKAGING (Cash&Carry = 1 L)**

L: 26 cm | 10.3 inch

W: 13 cm | 5.2 inch

H: 15 cm | 6 inch

Weight: 0,6 kg | 1.4 lb

**Master Pack (2 cash&carry)**

L: 28 cm | 11.1 inch

W: 27 cm | 10.7 inch

H: 16 cm | 6.3 inch

Weight: 1,4 kg | 3.1 lb

**PING** \*

ANDRAS RIGLER

2018



## Containers

-

### MATERIALS

Ceramic

### COLORS

White

### ORIGIN

Europe

119

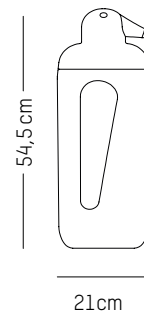
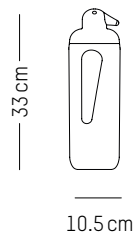
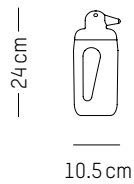
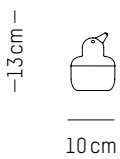

### Baby ping

-

**Ø:** 10 cm | 3.9 inch  
**H:** 13 cm | 5.1 inch  
**Weight:** 0,3 kg | 0.7 lb

#### PACKAGING :

**L:** 17 cm | 6.7 inch  
**W:** 17 cm | 6.7 inch  
**H:** 22,5 cm | 8.9 inch  
**Weight:** 0.5 kg | 1.1 lb

### Mama ping

-

**Ø:** 10,5 cm | 3.9 inch  
**H:** 24 cm | 9.4 inch  
**Weight:** 0,6 kg | 1.4 lb

#### PACKAGING :

**L:** 17 cm | 6.7 inch  
**W:** 17 cm | 6.7 inch  
**H:** 43 cm | 16.9 inch  
**Weight:** 0.86 kg | 1.9 lb

### Papa ping

-

**Ø:** 10,5 cm | 3.9 inch  
**H:** 33 cm | 13 inch  
**Weight:** 0,9 kg | 1.9 lb

#### PACKAGING :

**L:** 17 cm | 6.7 inch  
**W:** 17 cm | 6.7 inch  
**H:** 43 cm | 16.9 inch  
**Weight:** 1,3 kg | 2.9 lb

### Grand pa ping

-

**Ø:** 21 cm | 8.3 inch  
**H:** 54,5 cm | 21.3 inch  
**Weight:** 4,5 kg | 9.9 lb

#### PACKAGING :

**L:** 30 cm | 11.8 inch  
**W:** 30 cm | 11.8 inch  
**H:** 60 cm | 23.6 inch  
**Weight:** 5.5 kg | 13 lb

\* While stocks last

# SUCCESSION \*

## FÄRG & BLANCHE

2016



### Tableware

-

### MATERIALS

Culinary porcelain

### COLORS

Black, White

### ORIGIN

Europe

### TECHNICAL SPECIFICATIONS

FOOD SAFE

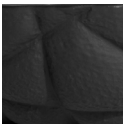

Black

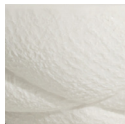

White

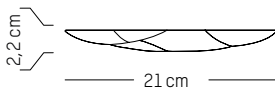

### Small plate (by 6)

-

**Ø:** 21 cm | 8.3 inch  
**H:** 2,2 cm | 0.9 inch  
**Weight:** 0,4 kg | 0.9 lb

### PACKAGING :

**L:** 22 cm | 8.7 inch  
**W:** 22 cm | 8.7 inch  
**H:** 10 cm | 3.9 inch  
**Weight:** 3 kg | 6.6 lb

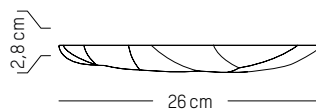

### Large plate (by 6)

-

**Ø:** 26 cm | 10.2 inch  
**H:** 2,8 cm | 1.1 inch  
**Weight:** 0,7 kg | 1.5 lb

### PACKAGING :

**L:** 29 cm | 11.4 inch  
**W:** 29 cm | 11.4 inch  
**H:** 11 cm | 4.3 inch  
**Weight:** 5,5 kg | 12.1 lb

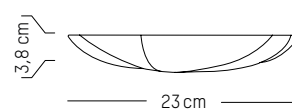

### Soup plate (by 6)

-

**Ø:** 23 cm | 9.1 inch  
**H:** 3,8 cm | 1.5 inch  
**Weight:** 0,6 kg | 1.3 lb

### PACKAGING :

**L:** 28,5 cm | 11.2 inch  
**W:** 28,5 cm | 11.2 inch  
**H:** 11 cm | 4.3 inch  
**Weight:** 3,7 kg | 8.2 lb

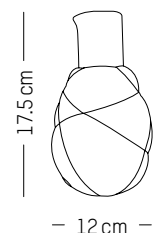

### Pitcher

-

**Ø:** 12 cm | 4.7 inch  
**H:** 17,5 cm | 6.9 inch  
**Weight:** 0,8 kg | 1.7 lb

### PACKAGING :

**L:** 20 cm | 7.9 inch  
**W:** 12,5 cm | 4.9 inch  
**H:** 14 cm | 5.5 inch  
**Weight:** 0,9 kg | 2 lb

\* While stocks last

# SUCCESSION \*

FÄRG & BLANCHE

2016

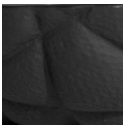

Black



White

## Tableware

-

### MATERIALS

Culinary porcelain

### COLORS

Black, White

### ORIGIN

Europe

### TECHNICAL SPECIFICATIONS

FOOD SAFE

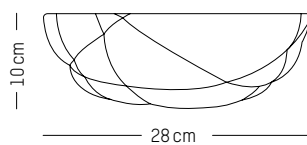

## Serving bowl

-

**Ø:** 28 cm | 11 inch

**H:** 10 cm | 3.9 inch

**Weight:** 1,6 kg | 3.9 lb

### PACKAGING :

**L:** 32 cm | 12.6 inch

**W:** 32 cm | 12.6 inch

**H:** 11 cm | 4.3 inch

**Weight:** 1,8 kg | 4 lb

\* While stocks last

# CONSTELLATION 1 AND 2 \*

LESLIE DAVID

2017



## CONSTELLATION 1



Ink

## CONSTELLATION 2



Cream

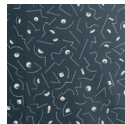

Ink



**L:** 1000 cm | 393.7 inch  
**W:** 70 cm | 27.6 inch  
**Weight:** 1 kg | 2.2 lb

### PACKAGING :

**Ø:** 13,6 cm | 5.3 inch  
**H:** 74 cm | 29.1 inch  
**Weight:** 1.2 kg | 2.6 lb

## Wallpaper

-

### MATERIALS

Non-woven wallpaper 1476/M2

### COLORS

Cream, Ink

### ORIGIN

France

### TECHNICAL SPECIFICATIONS

CERTIFICATION EUROCLASS B-S1,D0

 Apply Paste to the wall

 Dry peelable

 Light-proof

 Washable



**DOTS** \*

*SHELLEY STEER*

2017

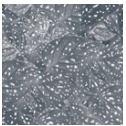

White on  
black

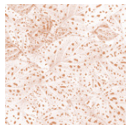

Copper

## Wallpaper

-

### MATERIALS

Non-woven wallpaper 1476/M2

### COLORS

Black, Copper

### ORIGIN

France

### TECHNICAL SPECIFICATIONS

CERTIFICATION EUROCLASS B-S1,D0

 Apply Paste to the wall

 Dry peelable

 Light-proof

 Washable

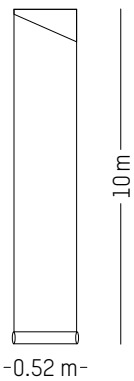

**L:** 1000 cm | 393.7 inch

**W:** 52 cm | 20.5 inch

**Weight:** 1 kg | 2.2 lb

### PACKAGING :

**Ø:** 13,6 cm | 5.3 inch

**H:** 74 cm | 29.1 inch

**Weight:** 1.2 kg | 2.6 lb

# JUNGLE

TIPHAINE DE BODMAN

2015



White on black



Black



Copper



Ink

## Wallpaper

-

### MATERIALS

Non-woven wallpaper 1476/M2

### COLORS

White on black, Black, Copper, Ink

### ORIGIN

France

### TECHNICAL SPECIFICATIONS

CERTIFICATION EUROCLASS B-S1,D0

 Apply Paste to the wall

 Dry peelable

 Light-proof

 Washable

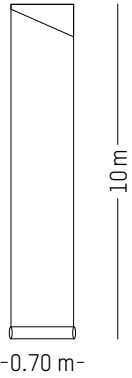

**L:** 1000 cm | 393.7 inch

**W:** 70 cm | 27.6 inch

**Weight:** 1 kg | 2.2 lb

### PACKAGING :

**Ø:** 13,6 cm | 5.3 inch

**H:** 74 cm | 29.1 inch

**Weight:** 1.2 kg | 2.6 lb

**JUNGLE** \*

TIPHAINE DE BODMAN

2015



**Napkin**

-

**MATERIALS**

Paper

**COLORS**

White on black

**ORIGIN**

France

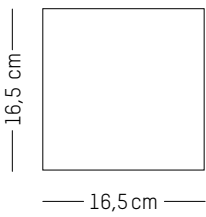

**L:** 16,5 cm | 7 inch  
**W:** 16,5cm | 7 inch  
**Weight:** 0.5 kg | 1.1 lb

\* While stocks last

# MINERALS \*

SHELLEY STEER

2017



Black-pink



Turquoise-Coral

## Wallpaper

-

### MATERIALS

Non-woven wallpaper 1476/M2

### COLORS

Black-pink, Turquoise-Coral,

### ORIGIN

France

### TECHNICAL SPECIFICATIONS

CERTIFICATION EUROCLASS B-S1,D0

 Apply Paste to the wall

 Dry peelable

 Light-proof

 Washable

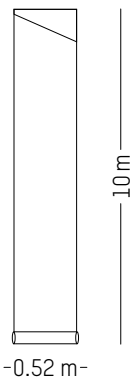

**L:** 1000 cm | 393.7 inch

**W:** 52 cm | 20.5 inch

**Weight:** 1 kg | 2.2 lb

### PACKAGING :

**Ø:** 13,6 cm | 5.3 inch

**H:** 74 cm | 29.1 inch

**Weight:** 1.2 kg | 2.6 lb

# UTOPIA ASCENDING \*

ANA MONTIEL

2017



Cream



Ink

## Wallpaper

-

### MATERIALS

Non-woven wallpaper 1476/M2

### COLORS

Cream, Ink

### ORIGIN

France

### TECHNICAL SPECIFICATIONS

CERTIFICATION EUROCLASS B-S1,D0

 Apply Paste to the wall

 Dry peelable

 Light-proof

 Washable

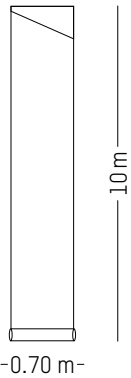

**L:** 1000 cm | 393.7 inch

**W:** 70 cm | 27.6 inch

**Weight:** 1 kg | 2.2 lb

### PACKAGING :

**Ø:** 13,6 cm | 5.3 inch

**H:** 74 cm | 29.1 inch

**Weight:** 1.2 kg | 2.6 lb

## VARIATIONS

TIPHAINE DE BODMAN

2014

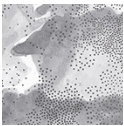

Black

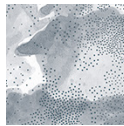

Ink

### Wallpaper

-

#### MATERIALS

Non-woven wallpaper 1476/M2

#### COLORS

Black, Ink

#### ORIGIN

France

#### TECHNICAL SPECIFICATIONS

 Apply Paste to the wall

 Dry peelable

 Light-proof

 Washable

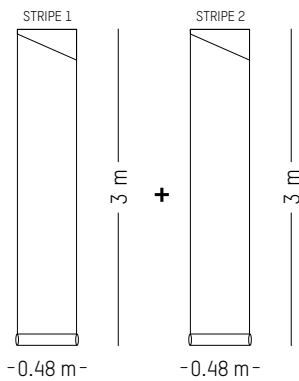

**Ø:** 300 cm | 118.1 inch  
**W:** 48cm | 18.9 inch  
**Weight:** 0,3 kg | 0.6 lb

#### PACKAGING :

**Ø :** 10 cm | 3.9 inch  
**H :** 51,5 cm | 20.3 inch  
**Weight:** 0,5 kg | 1.1 lb



# VOLUTES\*

TIPHAINE DE BODMAN

2017

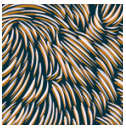

Black

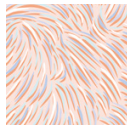

Pink

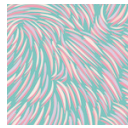

Green

## Wallpaper

-

### MATERIALS

Non-woven wallpaper 1476/M2

### COLORS

Black, Pink, Green

### ORIGIN

France

### TECHNICAL SPECIFICATIONS

CERTIFICATION EUROCLASS B-S1,D0

 Apply Paste to the wall

 Dry peelable

 Light-proof

 Washable

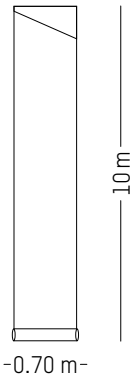

**L:** 1000 cm | 393.7 inch

**W:** 70 cm | 27.6 inch

**Weight:** 1 kg | 2.2 lb

### PACKAGING :

**Ø:** 13,6 cm | 5.3 inch

**H:** 74 cm | 29.1 inch

**Weight:** 1.2 kg | 2.6 lb

# Petite Friture

## **PETITE FRITURE**

**45 TER RUE DE LA REVOLUTION 93100 MONTREUIL**  
T + 33 (0)1 44 54 13 95

SAS au capital de 85 778€ - R.C.S Paris 513 649 343

*[www.petitefriture.com](http://www.petitefriture.com)*