

**Petite
Friture**

COLLECTION
2022

PETITE FRITURE, LIBRE GARDE design editor, was founded 10 years ago by Amélie du Passage, placing bold, talented, emerging designers at the heart of its singular collections.

Its vocation: to arouse emotions that send out vibrations through time and space. Each project is born of an intuitive and optimistic encounter between designer, editor, and manufacturer.

Petite Friture is proud to take a stand, to seek out the best solutions at every step of the way, to use the right techniques and right people to better serve the planet and do something good.

From an effervescent blend comes a sense of drive, a desire to work towards something sincere.

Transparency, respect, dialogue - our brand is one that seeks a sustainable future for decades to come. Petite Friture is more than just a design editor, it is a state of mind grounded in trust and optimism. Its ambition is to create virtuous beauty that will last for many years to come.

NEW

LED LIGHTING



OUASAR
SAMY RID



MEDITERRANEA
NOË DUCHAUFOUR-LAWRANCE



VERTIGO NOVA
CONSTANCE GUISET



UNSEEN
STUDIO PEPE



CHERRY
DANIEL • EMMA



LIGHTING



VERTIGO
CONSTANCE GUISET



LANTERNA
SAM BARON



SO-SAGE
SAM BARON



TIDLIGHT
PIERRE FAVRESSE



GRILLO
ELISE FOJN

FURNITURE



TAVLA
POOL



UNIFY
ANNE HARVALA



PARROT
INDIA MAHDVI



FRANCIS
CONSTANCE GUISET



ISO-A & B
POOL



HOLLO
AC/AL STUDIO



FROMME
TOM CHUNG



FROMME SOFT
TOM CHUNG



TRAME
AC/AL STUDIO



HOFF
MORTEN & JONAS



NUBILLO
CONSTANCE GUISET



GRID
POOL



LILY
FÄRGSBLANCHE

NEW

OUTDOOR



WEEK-END
STUDIO BRICHTZIEGLER



DECORATION



SUCCESSION
FÄRGS & BLANCHE x PETITE FRITURE & REVOL

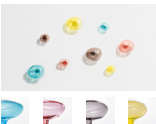

BUBBLE
VAULOT & D'YVÈRE



PING
ANDRAS RIGLER



DONUTS
PIA CHEVALIER

NEW

WALL COVERING



VARIATIONS WALLPAPERS
TIPHAINE DE BODMAN



JUNGLE WALLPAPERS
TIPHAINE DE BODMAN



VOLUTES WALLPAPERS
TIPHAINE DE BODMAN



DOTS WALLPAPERS
SHELLEY STEER

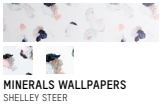

MINERALS WALLPAPERS
SHELLEY STEER



CONSTELLATION WALLPAPERS
LESLIE DAVID



UTOPIA ASCENDING
WALLPAPERS
ANA MONTIEL

Collection

01 LED LIGHTING

P. 6

02 LIGHTING

P. 29

03 FURNITURE

P. 38

04 UPHOLSTERY

P. 70

05 OUTDOOR

P. 95

06 DECORATION

P. 116

LED LIGHTING

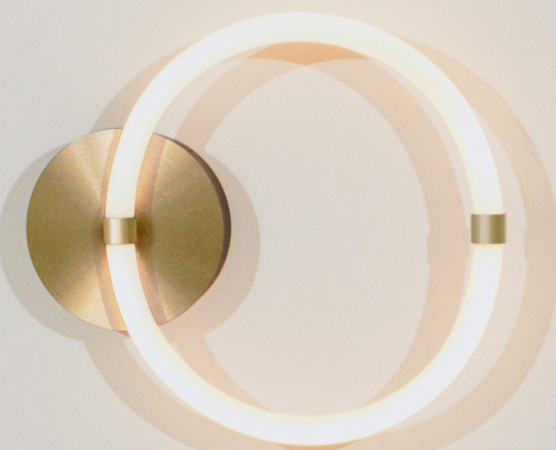

QUASAR

SAMY RIO

2021



Black



Natural



Sienna



Olive green



Emerald green

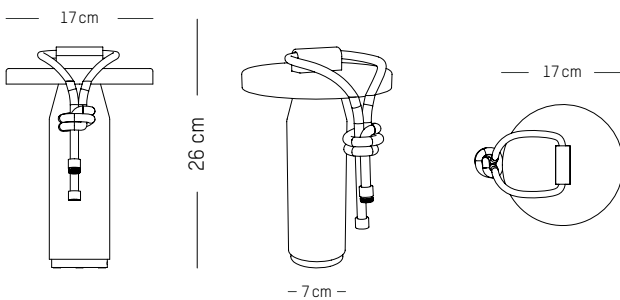

Small

Ø TOP: 17 cm | 6.7 inch
Ø BOTTOM: 7 cm | 2.8 inch
H: 26 cm | 10.1 inch
Weight: 1,3 kg | 2.9 lb

PACKAGING (pack cash and carry)

L: 18 cm | 7.1 inch
W: 18 cm | 7.1 inch
H: 29 cm | 11.4 inch
Weight: 2 kg | 4.4 lb

Indoor/Outdoor lamp

MATERIALS

Anodized aluminium, PC, ABS and polyester.

COLORS

Natural aluminium, Sienna, Black, Emerald green, Olive green.

ORIGIN

CHINA

TECHNICAL SPECIFICATIONS



3 light intensities (100%, 50%, 25%)

LED input:
250 lumens

LED output:
150 lumens

CHERRY

DANIEL ET EMMA

2021

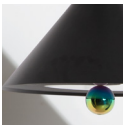

Black and rainbow



White and gold



Brown-red and rose gold



Mint-green and titanium

Pendant lamp

-

MATERIALS

Aluminium, matt grained powder coating; mirror finish steel; disseminating fire resistant plexiglass; Fabric cable, white or black, 3m /118.1 inch; steel ceiling cup white or black ; Integrated LED

COLORS

Black and rainbow, white and gold, red brown and rose gold, mint green and titanium

ORIGIN

France

TECHNICAL SPECIFICATIONS



LED input:
1040 lumens



Integrated LED



EUROPE

UK

US



Power

220-240V, 50-60Hz

Power

220-240V, 50-60Hz

Power

110-120V, 60Hz



XS

-

D: 9,3 cm | 3.6 inch
H: 17 cm | 6.7 inch
Ø (sphere): 5,1 cm | 0.2 inch
Canopy: Ø 15cm | 5.9 inch
Weight: 0,9 kg | 2 lb

PACKAGING :

Type: Carton box
L: 19,6 cm | 8 inch
W: 19,6 cm | 8 inch
H: 24,4 cm | 9.7 inch
Weight: 1,4 kg | 3 lb

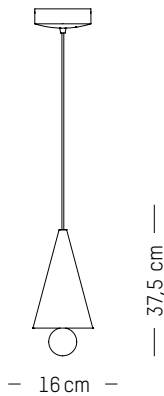

S

-

D: 16 cm | 6.3 inch
H: 37,5 cm | 15 inch
Ø (sphere): 7,6 cm | 0.3 inch
Canopy: Ø 15cm | 5.9 inch
Weight: 1,2 kg | 2.7 lb

PACKAGING :

Type: Carton box
L: 22,5 cm | 9 inch
W: 22 cm | 8.6 inch
H: 50 cm | 17 inch
Weight: 1,8 kg | 4 lb

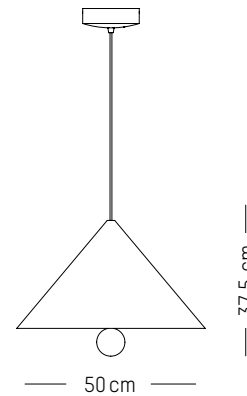

L

-

D: 50 cm | 19.7 inch
H: 37,5 cm | 15 inch
Ø (sphere): 7,6 cm | 0.3 inch
Canopy: Ø 15cm | 5.9 inch
Weight: 2,5 kg | 5.5 lb

PACKAGING :

Type: Carton box
L: 58,5 cm | 23 inch
W: 58,5 cm | 23 inch
H: 51 cm | 17.5 inch
Weight: 5,450 kg | 12.2 lb

CHERRY

DANIEL ET EMMA

2021



White

Linear canopy configuration

MATERIALS

Steel, matt grained powder coating; Aluminium, matt grained powder coating; mirror finish steel; disseminating fire resistant plexiglass; Fabric cable, white or black, 3m /118.1 inch; steel ceiling cup white or black; Integrated LED
5 outputs for Cherry pendant light
Mounting bracket system
Plastic caps to hide non used outputs

COLORS

White

ORIGIN

France

2 POSSIBLE CONFIGURATIONS :

5 PCS XS CHERRY PENDANT OR 3 PCS S CHERRY PENDANT

TECHNICAL SPECIFICATIONS

5X OR 3X

LED 24V~7.8 W LED input: 1040 lumens

1 P 2 0

Integrated LED



EUROPE

UK

CE

CE

Power

220-240V, 50-60Hz

Power

220-240V, 50-60Hz

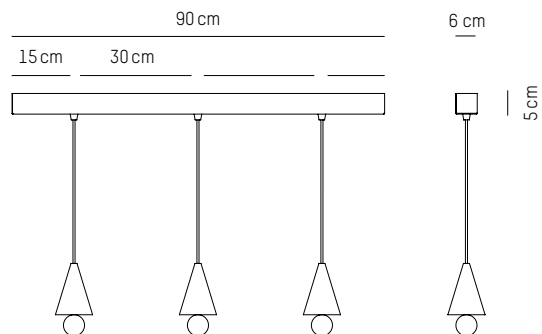
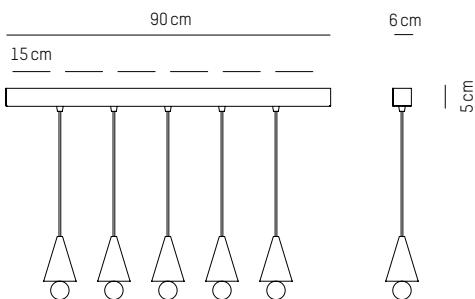

Linear canopy

5 PCS XS CHERRY PENDANT

L: 90 cm | 35 inch
W: 6 cm | 2.4 inch
H: 5 cm | 1.9 inch
Weight: 3,9 kg | 8.6 lb

PACKAGING :

Type: Carton box
L: 91 cm | 35.6inch
W: 17 cm | 6.6 inch
H: 27 cm | 10.6 inch

Linear canopy

3 PCS S CHERRY PENDANT

L: 90 cm | 35 inch
W: 6 cm | 2.4 inch
H: 5 cm | 1.9 inch
Weight: 3,4 kg | 7.5 lb

PACKAGING :

Type: Carton box
L: 91 cm | 35.6inch
W: 17 cm | 6.6 inch
H: 27 cm | 10.6 inch

CHERRY

DANIEL ET EMMA

2021



White

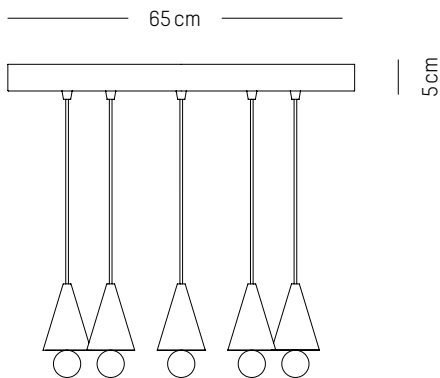

Round canopy

Ø: 65 cm | 25.6 inch
H: 5 cm | 2 inch
Weight: 5,9 kg | 13 lb

PACKAGING :

Type: Carton box
L: 67 cm | 26.5 inch
W: 66 cm | 26 inch
H: 27 cm | 10.06 inch
Weight: 8 kg | 17.7 lb

Round canopy configuration

MATERIALS

Steel, matt grained powder coating; Aluminium, matt grained powder coating; mirror finish steel; disseminating fire resistant plexiglass; Fabric cable, white or black, 33m /118.1 inch; steel ceiling cup white or black; Integrated LED
5 outputs for Cherry pendant light
Mounting bracket system
Plastic caps to hide non used outputs

COLORS

White

ORIGIN

France

1 POSSIBLE CONFIGURATIONS :
5 PCS XS CHERRY PENDANT

TECHNICAL SPECIFICATIONS

5X

LED
24V~7.8 W

LED input:
1040 lumens

1 P
2 0

Integrated LED



EUROPE

UK

CE

CE

Power

220-240V, 50-60Hz

Power

220-240V, 50-60Hz

UNSEEN

STUDIO PEPE

2020



Pendant lamps

MATERIALS

Smooth powder coated steel, varnished brass, polycarbonate tube

Lighting system: integrated LED

COLORS

Brass and translucent

ORIGIN

France

TECHNICAL SPECIFICATIONS

TRIPLE PENDANT

LED
28W LED input:
2410 lumens

QUINTUPLE PENDANT

LED
48.2W LED input:
4730 lumens

IP
20

Dimmable

2700K

EUROPE

UK

US

CE

CE

UL US

Power
220-240 V 50-60HZ

Power
220-240 V 50-60 HZ

Power
110-120 V 60 HZ

12

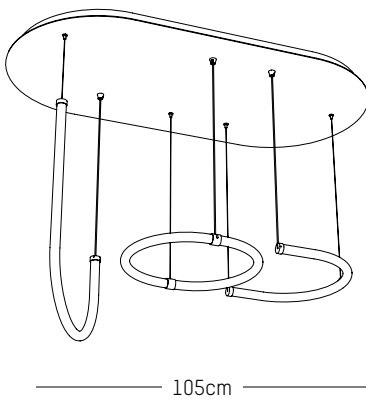

Triple pendant system

L: 105 cm | 41.3 inch
W: 53 cm | 21 inch
H: 82 cm | 33 inch
Weight: 15 kg | 33 lb

PACKAGING :

L: 86,7 cm | 34.1 inch
W: 115 cm | 45.3 inch
H: 58 cm | 26.8 inch
Weight: 17 kg | 37.5 lb

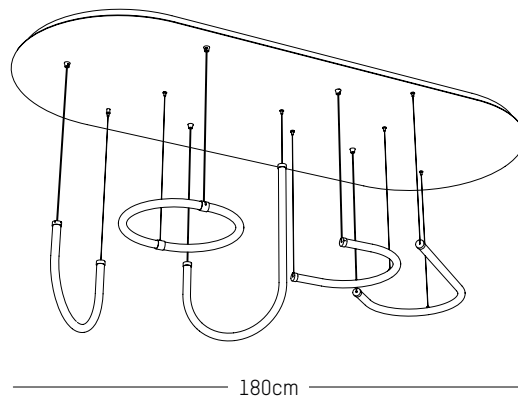

Quintuple pendant system

L: 180 cm | 70.9 inch
W: 73 cm | 29 inch
H: 82 cm | 32.3 inch
Weight: 40 kg | 88.2 lb

PACKAGING :

L: 86,7 cm | 34.1 inch
W: 200 cm | 78.7 inch
H: 83 cm | 32.7 inch
Weight: 50 kg | 110.2 lb

UNSEEN

STUDIO PEPE

2020



Wall lamp

-

MATERIALS

Smooth powder coated steel, varnished brass, polycarbonate tube

Lighting system: integrated LED

COLORS

Brass and translucent

ORIGIN

France

TECHNICAL SPECIFICATIONS



LED input:
660 lumens



EUROPE

UK

US



Power

220-240 V 50-60HZ

Power

220-240 V 50-60 HZ

Power

110-120 V 60 HZ

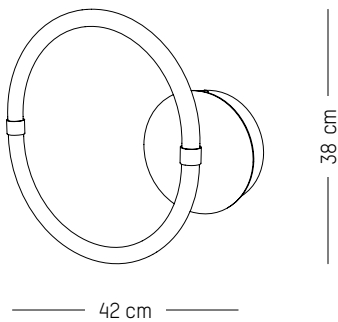

Wall Lamp 0

-

L: 42 cm | 16.5 inch

D: 7 cm | 2.8 inch

H: 38 cm | 14.9 inch

Weight: 1,4 kg | 3.1 lb

PACKAGING :

L: 46,7 cm | 18.4 inch

W: 42,7 cm | 16.7 inch

H: 68 cm | 26.7 inch

Weight: 3 kg | 6.6 lb

UNSEEN

STUDIO PEPE

2020

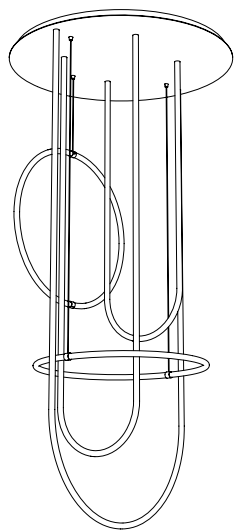
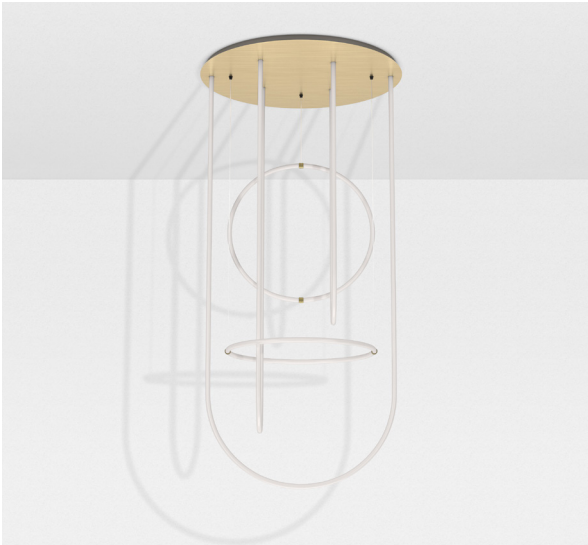

100 cm

L: 100 cm | 40 inch
H: 210 cm | 82.7 inch
Weight: 27 kg | 59.5 lb

PACKAGING :

L: 150 cm | 59 inch
W: 250 cm | 98 inch
H: 83 cm | 33 inch
Weight: 50 kg | 110 lb

Chandelier

-

MATERIALS

Smooth powder coated steel, varnished brass, polycarbonate tube

Lighting system: integrated LED

COLORS

Brass and translucent

ORIGIN

France

TECHNICAL SPECIFICATIONS



LED input:
15883 lumens



EUROPE

UK

US



Power
220-240 V 50-60HZ

Power
220-240 V 50-60 HZ

Power
110-120 V 60 HZ

UNSEEN

STUDIO PEPE

2020



Table lamps

-

MATERIALS

Smooth powder coated steel, varnished brass, polycarbonate tube

Lighting system: integrated LED

COLORS

Brass and translucent

ORIGIN

France

TECHNICAL SPECIFICATIONS

SMALL

LED
7.8W LED input:
670 lumens

LARGE

LED
16W LED input:
1650 lumens

IP
20

Dimmable

2200K 2700K 3000K 3500K 4000K

EUROPE

UK

US

CE

CE

UK PLUS

cUL US

Power

220-240 V 50-60HZ

Power

220-240 V 50-60 HZ

Power

110-120 V 60 HZ

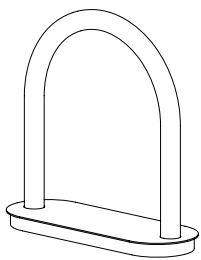

28 cm

Small table lamp

-

L: 28 cm | 11 inch

H: 28 cm | 11 inch

D: 10 cm | 4 inch

Weight: 1,5 kg | 3.3 lb

Cable length: 175cm | 68.9 inch

PACKAGING :

L: 31 cm | 12.2 inch

W: 15 cm | 5.9 inch

H: 32 cm | 12.6 inch

Weight: 3 kg | 6.6 lb

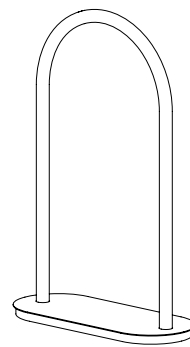

40 cm

Large table lamp

-

L: 40 cm | 16 inch

H: 60 cm | 23.7 inch

D: 16,5 cm | 7 inch

Weight: 3 kg | 6.6 lb

Cable length: 175cm | 68.9 inch

PACKAGING :

L: 70 cm | 27.6 inch

W: 20 cm | 8 inc

H: 70 cm | 27.6 inch

Weight: 5 kg | 11 lb

UNSEEN

STUDIO PEPE

2020



Pendant lamp U



Pendant lamp O

Pendant lamps

-

MATERIALS

Smooth powder coated steel, varnished brass, polycarbonate tube

Lighting system: integrated LED

COLOURS

Brass and translucent

ORIGIN

France

TECHNICAL SPECIFICATIONS

For recess ceiling

LAMP J

LED 12W LED input: 1030 lumens

LAMP O

LED 7.6W LED input: 660 lumens

LAMP U

LED 8.5W LED input: 720 lumens



EUROPE

UK



Power

220-240 V 50-60HZ

Power

220-240 V 50-60 HZ

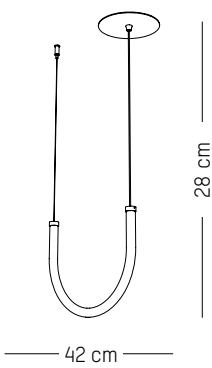

Pendant lamp U

-

L: 42 cm | 16.5 inch
D: 2,4 cm | 1 inch
H: 28 cm | 11 inch
Weight: 0,96 kg | 2.12 lb
Cable length (max): 2,5 m | 99 inch

PACKAGING :

L: 46,7 cm | 18.4 inch
W: 42,6 cm | 16.8 inch
H: 6,8 cm | 2.7 inch
Weight: 1,9 kg | 4.2 lb

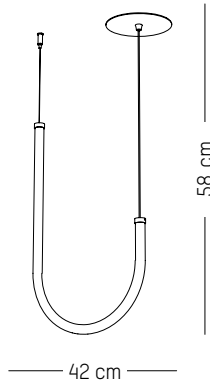

Pendant lamp J

-

L: 42 cm | 16.5 inch
D: 2,4 cm | 1 inch
H: 58 cm | 22.8 inch
Weight: 1,5 kg | 3.3 lb
Cable length (max): 2,5 m | 99 inch

PACKAGING :

L: 62,5 cm | 24.6 inch
W: 46,7 cm | 18.4 inch
H: 6,8 cm | 2.7 inch
Weight: 2,5 kg | 5.5 lb

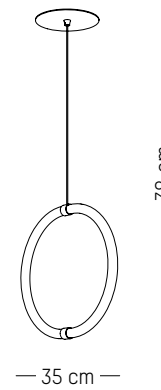

Pendant lamp O

-

L: 35 cm | 14 inch
D: 2,4 cm | 1 inch
H: 38 cm | 17.8 inch
Weight: 1,4 kg | 3.1 lb
Cable length (max): 2,5 m | 99 inch

PACKAGING :

L: 46,7 cm | 18.4 inch
W: 42,6 cm | 16.8 inch
H: 6,8 cm | 2.7 inch
Weight: 2,5 kg | 5.5 lb

UNSEEN

STUDIO PEPE

2020



Pendant lamps canopy

-

MATERIALS

Varnished brass

COLOUR

Brass

ORIGIN

France

TECHNICAL SPECIFICATIONS

To combine with unit pendant lamp for regular ceiling

🇪🇺 EUROPE

🇬🇧 UK

CE

CE

17

17

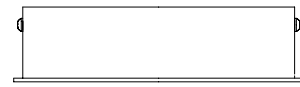
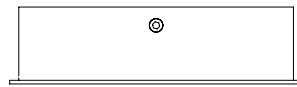
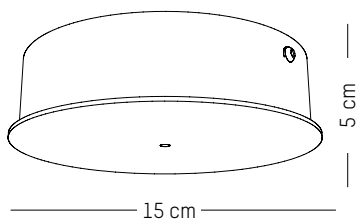

Pendant lamp canopy

-

Ø: 15 cm | 5.9 inch

H: 5 cm | 2 inch

Weight: 0,9 kg | 2 lb

PACKAGING :

L: 15 cm | 5.9 inch

W: 15 cm | 5.9 inch

H: 16 cm | 6.3 inch

Weight: 1,1 kg | 2.43 lb

UNSEEN

STUDIO PEPE

2020



Pendant lamp U



Pendant lamp O

Pendant lamps

-

MATERIALS

Smooth powder coated steel, varnished brass, polycarbonate tube

Lighting system: integrated LED

COLOURS

Brass and translucent

ORIGIN

France

TECHNICAL SPECIFICATIONS

Can be used on recess and regular ceilings

LAMP J

LED
12W

LED input:
1030 lumens

LAMP O

LED
7.6W

LED input:
660 lumens

LAMP U

LED
8.5W

LED input:
720 lumens



Power

110-120 V 60 HZ

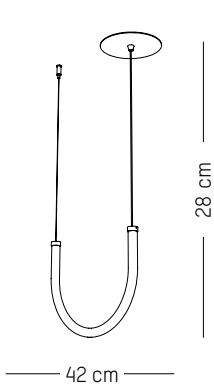

Pendant lamp U

L: 42 cm | 16.5 inch
D: 2,4 cm | 1 inch
H: 28 cm | 11 inch
Weight: 0,96 kg | 2.12 lb
Cable length (max): 2,5 m | 99 inch

PACKAGING :

L: 46,7 cm | 18.4 inch
W: 42,6 cm | 16.8 inch
H: 6,8 cm | 2.7 inch
Weight: 1,9 kg | 4.2 lb

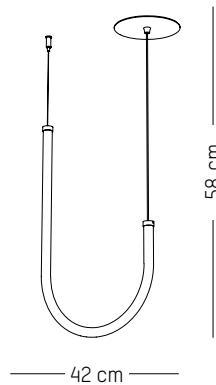

Pendant lamp J

L: 42 cm | 16.5 inch
D: 2,4 cm | 1 inch
H: 58 cm | 22.8 inch
Weight: 1,5 kg | 3.3 lb
Cable length (max): 2,5 m | 99 inch

PACKAGING :

L: 62,5 cm | 24.6 inch
W: 46,7 cm | 18.4 inch
H: 6,8 cm | 2.7 inch
Weight: 2,5 kg | 5.5 lb

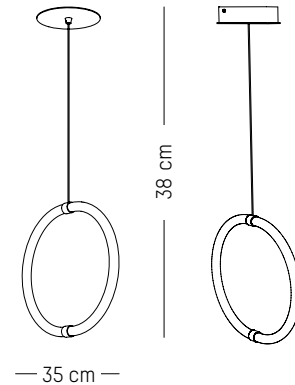

Pendant lamp O

L: 35 cm | 14 inch
D: 2,4 cm | 1 inch
H: 38 cm | 17.8 inch
Weight: 1,4 kg | 3.1 lb
Cable length (max): 2,5 m | 99 inch

PACKAGING :

L: 46,7 cm | 18.4 inch
W: 42,6 cm | 16.8 inch
H: 6,8 cm | 2.7 inch
Weight: 2,5 kg | 5.5 lb

UNSEEN

STUDIO PEPE

2020



FOR CONTRACT PROJECT WITH MINIMUM QUANTITY

Ceiling plate for double pendant

-

MATERIALS

Smooth powder coated steel, varnished brass

COLOURS

Brass

ORIGIN

France

TECHNICAL SPECIFICATIONS

Ceiling plate sold separately to be combined with 2 different pendant lamps from UNSEEN collection

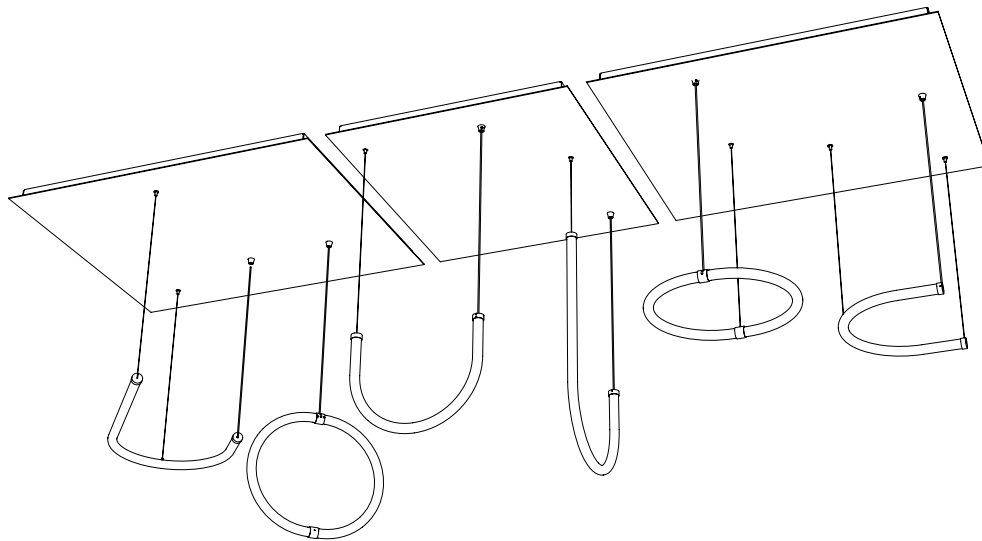

Ceiling plate for double pendant JO

-

L: 89 cm | 35.1 inch
W: 74 cm | 25.6 inch
H: 4 cm | 1.4 inch
Weight: 23 kg | 50.8 lb

PACKAGING :

L: 91 cm | 35.9 inch
W: 76 cm | 26.4 inch
H: 6 cm | 2.4 inch
Weight: 26 kg | 57.4 lb

Ceiling plate for double pendant UJ

-

L: 65 cm | 25.6 inch
W: 74 cm | 25.6 inch
H: 4 cm | 1.4 inch
Weight: 17 kg | 37.5 lb

PACKAGING :

L: 67 cm | 26.4 inch
W: 76 cm | 26.4 inch
H: 6 cm | 2.4 inch
Weight: 20 kg | 54.1 lb

Ceiling plate for double pendant OU

-

L: 85 cm | 33.5 inch
W: 74 cm | 25.6 inch
H: 4 cm | 1.4 inch
Weight: 23 kg | 50.8 lb

PACKAGING :

L: 87 cm | 34.3 inch
W: 76 cm | 26.4 inch
H: 6 cm | 2.4 inch
Weight: 26 kg | 57.4 lb

UNSEEN

STUDIO PEPE

2020

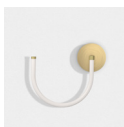

Wall lamp U

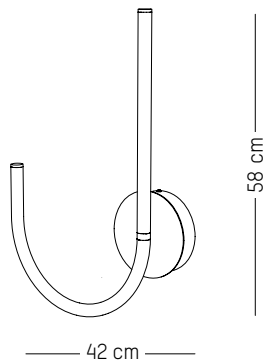

Wall lamp J

L: 42 cm | 16.5 inch
D: 7 cm | 2.8 inch
H: 58 cm | 22.8 inch
Canopy: Ø 15cm | 5.9 inch
Weight: 1,5 kg | 3.3 lb

PACKAGING :

L: 62,5 cm | 24.6 inch
W: 46,7 cm | 18.4 inch
H: 7 cm | 2.8 inch
Weight: 2,5 kg | 5.5 lb

FOR CONTRACT PROJECT WITH MINIMUM QUANTITY

Wall lamps

-

MATERIALS

Smooth powder coated steel, varnished brass, polycarbonate tube

Lighting system: integrated LED

COLOURS

Brass and translucent

ORIGIN

France

TECHNICAL SPECIFICATIONS

LAMP J

LED 12W LED input: 1030 lumens

LAMP U

LED 8.5W LED input: 720 lumens



EUROPE

UK

US



Power

220-240 V 50-60HZ

Power

220-240 V 50-60 HZ

Power

110-120 V 60 HZ

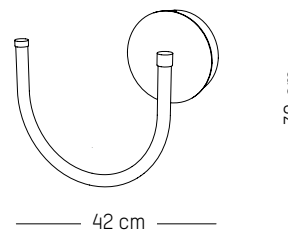

Wall lamp U

-

L: 42 cm | 16.5 inch
D: 7 cm | 2.8 inch
H: 38 cm | 14.9 inch
Canopy: Ø 15cm | 5.9 inch
Weight: 0,96 kg | 2.12 lb

PACKAGING :

L: 46,7 cm | 18.4 inch
W: 42,7 cm | 16.7 inch
H: 7 cm | 2.8 inch
Weight: 1,9 kg | 4.2 lb

VERTIGO NOVA

CONSTANCE GUISSET

2020



Black

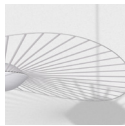

White

Pendant lamps

-

MATERIALS

Lampshade: Fiberglass, steel with matte grained powder coating, polyurethane ribbons, Glass: Glass triplex
Lighting system : integrated LED + painted aluminium
Cable: mesh textile

COLORS

Black, White

ORIGIN

France

TECHNICAL SPECIFICATIONS



LED input:
1350 lumens



EUROPE

UK

US



Power

220-240 V 50-60HZ

Power

220-240 V 50-60 HZ

Power

110-120 V 60 HZ

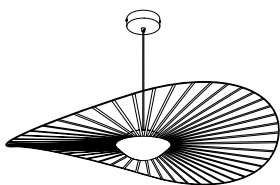

110 cm

Small

-

Ø: 110 cm | 43.3 inch
H: 11,5 cm | 4.53 inch
Weight: 2 kg | 4.4 lb
Cable length: 250 cm | 99 inch or
on demand: 1000 cm | 394 inch

PACKAGING :

L: 72 cm | 14.6 inch
W: 72 cm | 14.6 inch
H: 35 cm | 14.8 inch
Weight: 3,5 | 7.7 lb

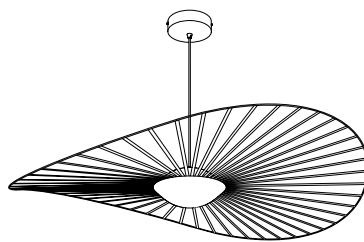

140 cm

Medium

-

Ø: 140 cm | 55.1 inch
H: 12 cm | 4.7 inch
Weight: 2,5 kg | 5.5 lb
Cable length: 250 cm | 99 inch or
on demand: 1000 cm | 394 inch

PACKAGING :

L: 72 cm | 14.6 inch
W: 72 cm | 14.6 inch
H: 35 cm | 14.8 inch
Weight: 4 kg | 8.8 lb

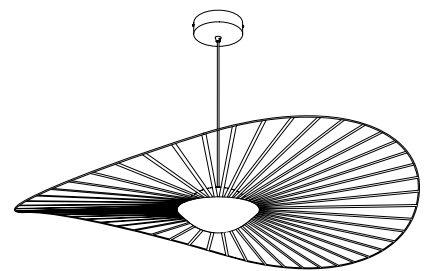

190 cm

Large

-

Ø: 190 cm | 74.8 inch
H: 13,2 cm | 5.2 inch
Weight: 3 kg | 6.8 lb
Cable length: 250 cm | 99 inch or
on demand: 1000 cm | 394 inch

PACKAGING :

L: 72 cm | 14.6 inch
W: 72 cm | 14.6 inch
H: 35 cm | 14.8 inch
Weight: 5 kg | 11 lb

VERTIGO NOVA

CONSTANCE GUISSET

2020



Black

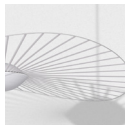

White

Wall lamp

-

MATERIALS

Lampshade: Fiberglass, painted steel with matte grained powder coating, polyurethane ribbons

Glass: Glass triplex, Lighting system : integrated LED

Cable: plastic. Included cable for regular plug

COLORS

Black, White

ORIGIN

France

TECHNICAL SPECIFICATIONS



LED input:
1350 lumens



EUROPE

UK

US



Power

220-240 V 50-60HZ

Power

220-240 V 50-60 HZ

Power

110-120 V 60 HZ

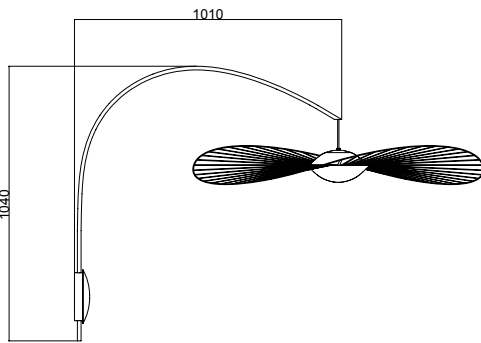

Ø: 110 cm | 43.3 inch

H: 104 cm | 41 inch

Canopy: Ø 15cm | 5.9 inch

Weight: 3,2 kg | 7 lb

PACKAGING :

Carton box 1

L: 130 cm | 51.2 inch

W: 61 cm | 24 inch

H: 15,7 cm | 6.2 inch

Weight: 5 kg | 11 lb

Carton box 2

L: 72 cm | 28.3 inch

W: 72 cm | 28.3 inch

H: 22 cm | 8.6 inch

Weight: 2 kg | 4.4 lb

VERTIGO NOVA

CONSTANCE GUISET

2020



Black

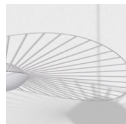

White

Floor lamp

-

MATERIALS

Lampshade: Fiberglass, painted steel with matte grained powder coating, polyurethane ribbons
Glass: Glass triplex, Lighting system : integrated LED
Cable: mesh textile + With foot dimmer

COLORS

Black, White

ORIGIN

France

TECHNICAL SPECIFICATIONS



LED input:
1350 lumens



EUROPE

UK

US



Power

220-240 V 50-60HZ

Power

220-240 V 50-60 HZ

Power

110-120 V 60 HZ

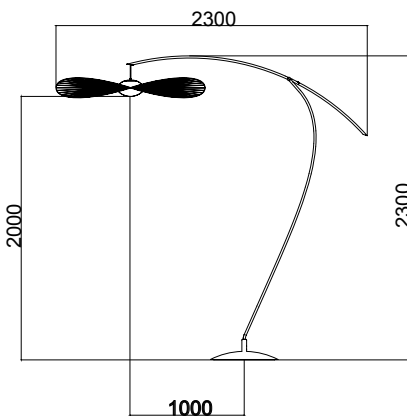

High position

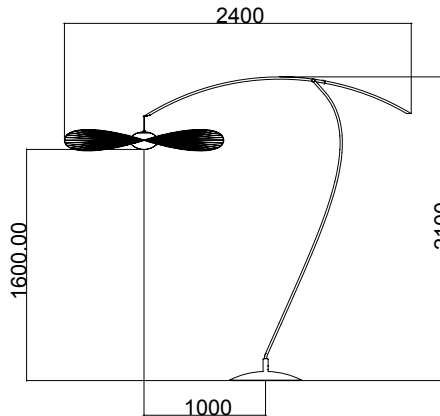

Low position

L (max): 240 cm | 95 inch
W: 167 cm | 65.7 inch
Ø: 110 cm | 43.3 inch
H (max): 230 cm | 91 inch
Weight: 20 kg | 44 lb

PACKAGING :

Carton box 1

L: 234 cm | 92.1 inch
W: 51,7 cm | 20.3 inch
H: 15,7 cm | 6.2 inch
Weight: 25 kg | 55.1 lb

Carton box 2

L: 72 cm | 28.3 inch
W: 72 cm | 28.3 inch
H: 22 cm | 8.6 inch
Weight: 2 kg | 4.4 lb

MEDITERRANEA

NOÉ DUCHAUFOUR-LAWRANCE

2016



Brushed brass

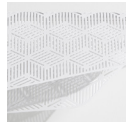

White*



Black*

Pendant lamp

-

MATERIALS

Brushed or painted brass
Lighting system: integrated LED

COLORS

Brushed brass, White, Black

ORIGIN

France

TECHNICAL SPECIFICATIONS

SMALL

LED
24V - 9W
LED input:
936 lumens

LARGE

LED
24V - 1W
LED input:
1620 lumens



EUROPE

UK



Power

220-240 V 50-60HZ

Power

220-240 V 50-60 HZ

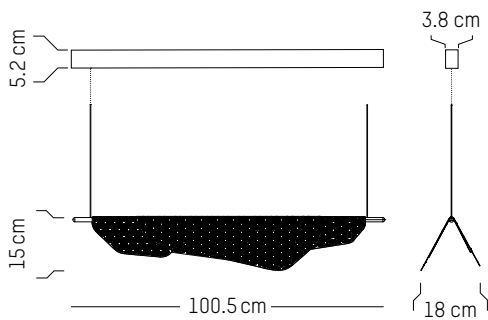

Small

L: 100,5 cm | 39.6 inch
W: 18 cm | 7.1 inch
H: 15 cm | 5.9 inch
Cable length: 200 cm | 79 inch
Weight: 4 kg | 8.8 lb

PACKAGING :

L: 109 cm | 42.9 inch
W: 25 cm | 9.9 inch
H: 30 cm | 11.8 inch
Weight: 4,7 kg | 10.4 lb

* While stocks last

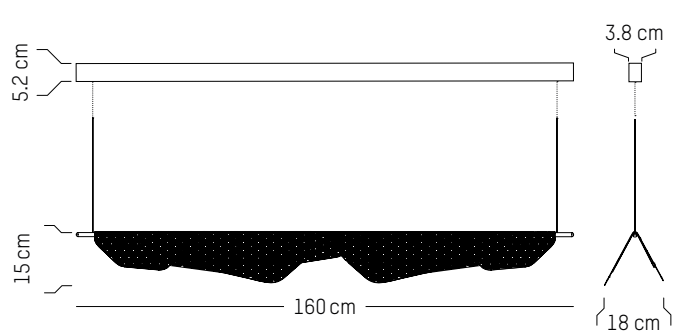

Large

L: 160 cm | 63 inch
W: 18 cm | 7.1 inch
H: 15 cm | 5.9 inch
Cable length: 200 cm | 79 inch
Weight: 6 kg | 13.2 lb

PACKAGING :

L: 167 cm | 65.7 inch
W: 25 cm | 9.9 inch
H: 30 cm | 11.8 inch
Weight: 7 kg | 15.4 lb

MEDITERRANEA

NOÉ DUCHAUFOUR-LAWRANCE

2016



Brushed brass

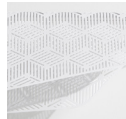

White*



Black*

Pendant lamp

-

MATERIALS

Brushed or painted brass

Lighting system: integrated LED

COLORS

Brushed brass, White, Black

ORIGIN

France

TECHNICAL SPECIFICATIONS

SMALL

LED
24V - 9W

LED input:
936 lumens

LARGE

LED
24V - 1W

LED input:
1620 lumens



US



Power

110-120 V 60 HZ

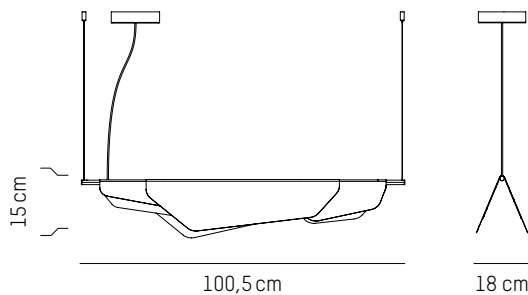

Small

L: 100,5 cm | 39.6 inch

W: 18 cm | 7.1 inch

H: 15 cm | 5.9 inch

Cable length: 200 cm | 79 inch

Weight: 4 kg | 8.8 lb

PACKAGING :

L: 109 cm | 42.9 inch

W: 25 cm | 9.9 inch

H: 30 cm | 11.8 inch

Weight: 4,7 kg | 10.4 lb

* While stocks last

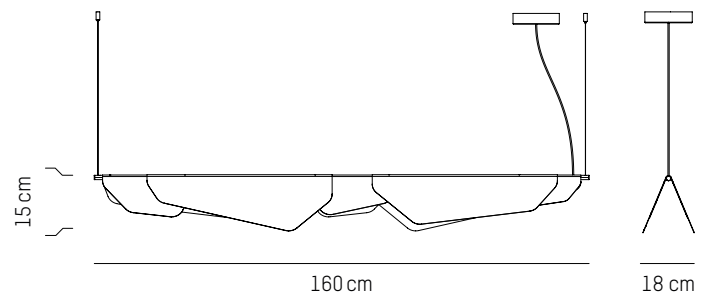

Large

L: 160 cm | 63 inch

W: 18 cm | 7.1 inch

H: 15 cm | 5.9 inch

Cable length: 200 cm | 79 inch

Weight: 6 kg | 13.2 lb

PACKAGING :

L: 167 cm | 65.7 inch

W: 25 cm | 9.9 inch

H: 30 cm | 11.8 inch

Weight: 7 kg | 15.4 lb

MEDITERRANEA

NOÉ DUCHAUFOUR-LAWRANCE

2016

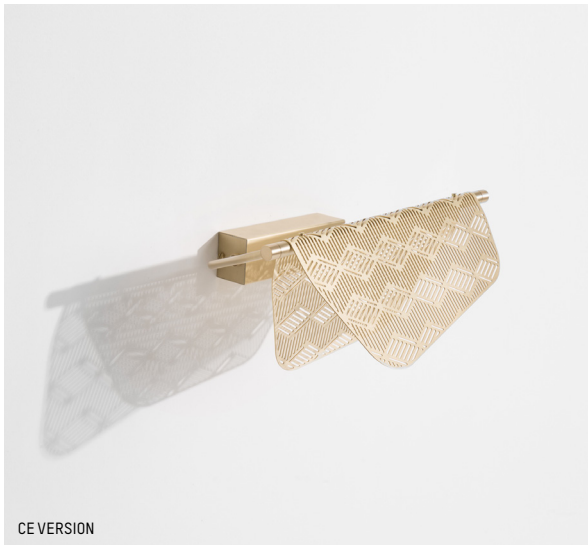

Brushed brass

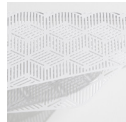

White*



Black*

Wall lamp

-

MATERIALS

Brushed or painted brass
Lighting system: integrated LED

COLORS

Brushed brass, White, Black

ORIGIN

France

TECHNICAL SPECIFICATIONS

LED 24V - 4W LED input: 324 lumens IP 20



EUROPE

UK



Power

220-240 V 50-60HZ

Power

220-240 V 50-60 HZ

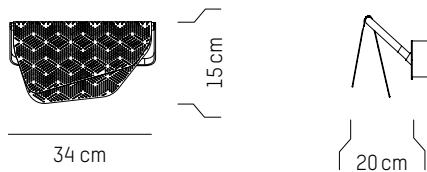

L: 34 cm | 13.4 inch
D: 20 cm | 7.9 inch
H: 15 cm | 5.9 inch
Weight: 1 kg | 2.2 lb

PACKAGING :

Type: Carton box
L: 42 cm | 16.5 inch
W: 32 cm | 12.6 inch
H: 24 cm | 9.5 inch
Weight: 2,1 kg | 4.6 lb

* While stocks last

MEDITERRANEA

NOÉ DUCHAUFOUR-LAWRANCE

2016

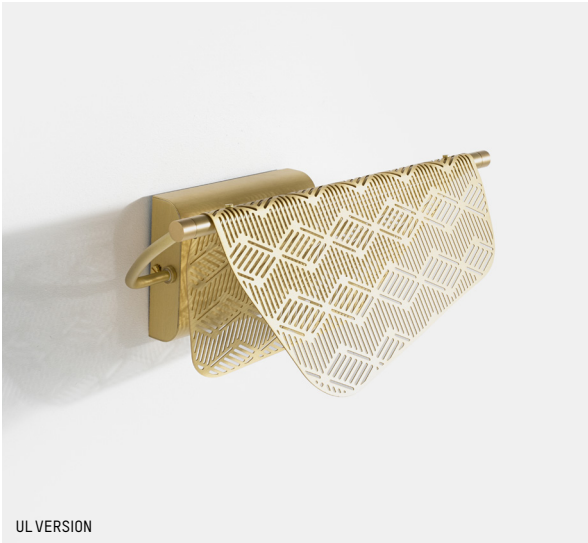

UL VERSION



Brushed brass



White*



Black*

Wall lamp

-

MATERIALS

Brushed or painted brass

Lighting system: integrated LED

COLORS

Brushed brass, White, Black

ORIGIN

France

TECHNICAL SPECIFICATIONS



LED input:
324 lumens



US



Power

110-120 V 60 HZ

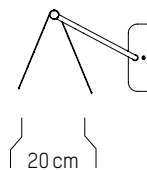
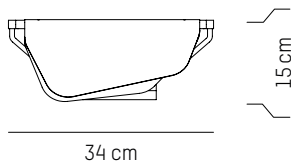

L: 34 cm | 13.4 inch

D: 20 cm | 7.9 inch

H: 15 cm | 5.9 inch

Weight: 1 kg | 2.2 lb

PACKAGING :

Type: Carton box

L: 42 cm | 16.5 inch

W: 32 cm | 12.6 inch

H: 24 cm | 9.5 inch

Weight: 2,1 kg | 4.6 lb

* While stocks last

MEDITERRANEA

NOÉ DUCHAUFOUR-LAWRANCE

2016



Brushed brass



White*



Black*

Table and Floor lamp

-

MATERIALS

Brushed or painted brass

Lighting system: integrated LED, Cable: plastic

COLORS

Brushed brass, White, Black

ORIGIN

France

TECHNICAL SPECIFICATIONS



LED input:
312 lumens



EUROPE

UK

US



Power

220-240 V 50-60HZ

Power

220-240 V 50-60 HZ

Power

110-120 V 60 HZ

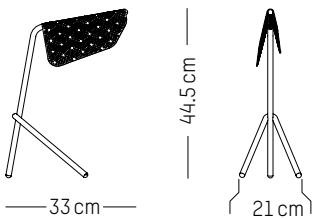

Table lamp

-

L: 33 cm | 13 inch

W: 21 cm | 8.3 inch

H: 44,5 cm | 17.5 inch

Cable length: 200 cm | 79 inch

Weight: 1,3 kg | 2.9 lb

PACKAGING :

Type: Carton box

L: 46 cm | 18.1 inch

W: 45 cm | 17.7 inch

H: 23 cm | 9.1 inch

Weight: 2,7 kg | 6 lb

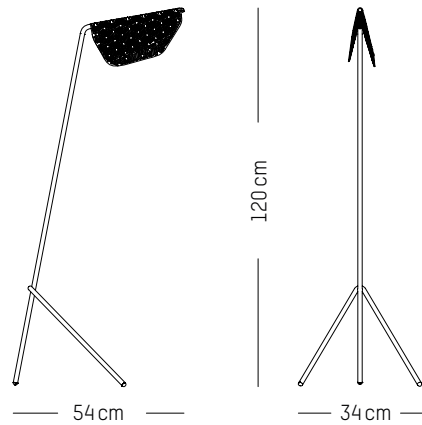

Floor lamp

-

L: 54 cm | 21.3 inch

W : 34 cm | 13.4 inch

H : 120 cm | 47.3 inch

Cable length : 200 cm | 79 inch

Weight: 2 kg | 4.4 lb

PACKAGING :

Type: Carton box

L: 133 cm | 54.4 inch

W: 54 cm | 21.3 inch

H: 25 cm | 9.8 inch

Weight: 6,6 kg | 14.6 lb

* While stocks last

L I G H T I N G



GRILLO

ELISE FOUIN

2014



White



Green

Wall lamp

-

MATERIALS

Perforated disc : aluminium, grained matte epoxy paint
Cable : textile

COLORS

White
Cable colors : White, Green

ORIGIN

France

TECHNICAL SPECIFICATIONS



Power

220-240 V 50-60HZ

Power

220-240 V 50-60 HZ

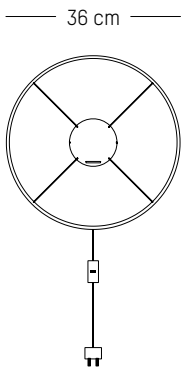

Grillo L

-

Ø: 36 cm | 14.2 inch
D: 10 cm | 3.9 inch
Cable length: 300 cm | 118 inch
Weight: 0,6 kg | 1.3 lb

PACKAGING :

Type: Carton box
L: 42 cm | 16.5 inch
W: 42 cm | 16.5 inch
H: 15 cm | 5.9 inch
Weight: 1,5 kg | 3.3 lb

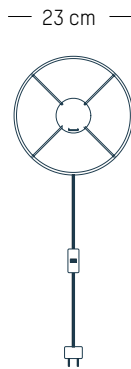

Grillo S

-

Ø: 23 cm | 9.1 inch
D: 10 cm | 3.9 inch
Cable length: 300 cm | 118 inch
Weight: 0,3 kg | 0.7 lb

PACKAGING :

Type: Carton box
L: 28 cm | 11 inch
W: 28 cm | 11 inch
H: 15 cm | 5.9 inch
Weight: 0,9 kg | 2 lb

LANTERNA

SAM BARON

2014



Black



White

Pendant lamp

-

MATERIALS

Structure: lacquered steel
Lampshade and cable: fabrics
Socket and ceiling cup: PVC

COLORS

Black, White

ORIGIN

Europe

TECHNICAL SPECIFICATIONS



EUROPE

UK

US



Power

220-240 V 50-60HZ

Power

220-240 V 50-60 HZ

Power

110-120 V 60 HZ

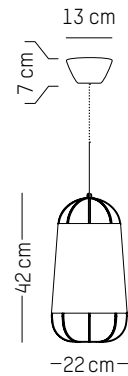

Small

-

Ø: 22 cm | 8.7 inch
H: 42 cm | 16.5 inch
Weight: 0,4 kg | 0.9 lb
Cable length: 250 cm | 99 inch or
on demand: 1000 cm | 394 inch

PACKAGING :

Type: Carton box
L: 27,5 cm | 10.8 inch
W: 27,5 cm | 10.8 inch
H: 48,5 cm | 19.1 inch
Weight: 1,3 kg | 2.9 lb

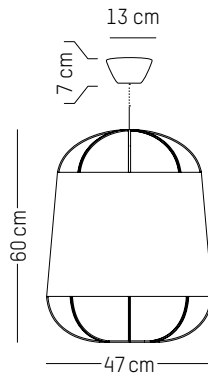

Medium

-

Ø: 47 cm | 18.5 inch
H: 60 cm | 23.6 inch
Weight: 0,8 kg | 1.8 lb
Cable length: 250 cm | 99 inch or
on demand: 1000 cm | 394 inch

PACKAGING :

Type: Carton box
L: 52,5 cm | 20.7 inch
W: 52,5 cm | 20.7 inch
H: 66,5 cm | 26.2 inch
Weight: 3,5 kg | 7.7 lb

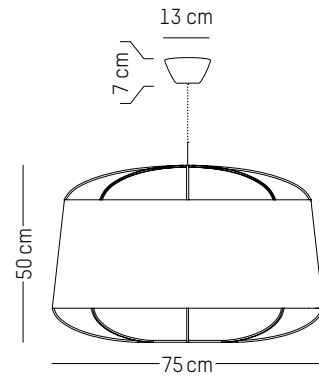

Large

-

Ø: 75 cm | 30 inch
H: 50 cm | 20 inch
Weight: 1,2 kg | 2.7 lb
Cable length: 250 cm | 99 inch or
on demand: 1000 cm | 394 inch

PACKAGING :

Type: Carton box
L: 81 cm | 31.9 inch
W: 58,1 cm | 31.9 inch
H: 55,5 cm | 21.9 inch
Weight: 6,8 kg | 15 lb

SO - SAGE

SAM BARON

2016



Pendant lamp

MATERIALS

Pendant: Borosilicate glass; Cable: textile
Ceiling rose : brass graphite finish, steel

COLORS

Clear-transparent

ORIGIN

France

TECHNICAL SPECIFICATIONS

Compatible transformer for variation with trailing edge phase control



Halogen

EUROPE

UK



Power

220-240 V 50-60HZ

Power

220-240 V 50-60 HZ

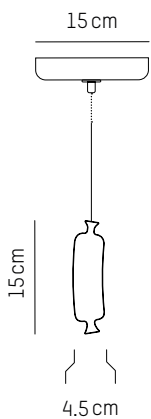

Diot

Ø: 4,2 cm | 1.7 inch
H: 15 cm | 5.1 inch
Cable: 175 cm | 69 in
Weight: 0,5 kg | 1.1 lb

PACKAGING :

L: 49 cm | 19.3 inch
W: 20 cm | 7.9 inch
H: 18 cm | 7.1 inch
Weight: 1,1 kg | 2.4 lb

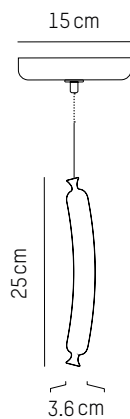

Strasbourg

Ø: 3,6 cm | 1.4 inch
H: 25 cm | 9.8 inch
Cable: 175 cm | 69 in
Weight: 0,6 kg | 1.3 lb

PACKAGING :

L: 49 cm | 19.3 inch
W: 20 cm | 7.9 inch
H: 18 cm | 7.1 inch
Weight: 1,1 kg | 2.4 lb

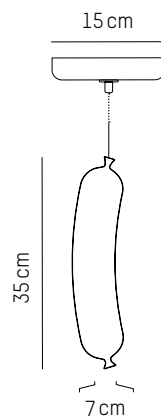

Morteau

Ø: 7 cm | 2.8 inch
H: 35 cm | 13.8 inch
Cable: 175 cm | 69 in
Weight: 0,9 kg | 2 lb

PACKAGING :

L: 49 cm | 19.3 inch
W: 20 cm | 7.9 inch
H: 18 cm | 7.1 inch
Weight: 1,1 kg | 2.4 lb

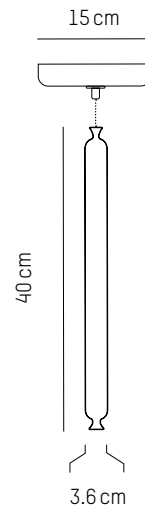

Gendarme

Ø: 3,6 cm | 1.4 inch
H: 40 cm | 15.9 inch
Cable: 175 cm | 69 in
Weight: 0,6 kg | 1.3 lb

PACKAGING :

L: 49 cm | 19.3 inch
W: 20 cm | 7.9 inch
H: 18 cm | 7.1 inch
Weight: 1,1 kg | 2.4 lb

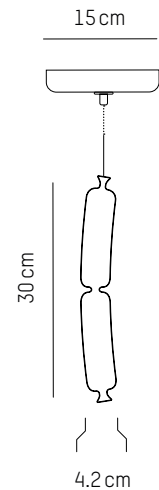

Toulouse

Ø: 4,2 cm | 1.7 inch
H: 30 cm | 11.8 inch
Cable: 175 cm | 69 in
Weight: 0,6 kg | 1.3 lb

PACKAGING :

L: 49 cm | 19.3 inch
W: 20 cm | 7.9 inch
H: 18 cm | 7.1 inch
Weight: 1,1 kg | 2.4 lb

SO - SAGE

SAM BARON

2016



Pendant lamp

-

MATERIALS

Pendant: Borosilicate glass; Cable: textile
Ceiling rose : brass graphite finish, steel

COLORS

Clear-transparent

ORIGIN

France

TECHNICAL SPECIFICATIONS

Compatible transformer for variation with trailing edge phase control



Halogen

EUROPE

UK



Power

220-240 V 50-60HZ

Power

220-240 V 50-60 HZ

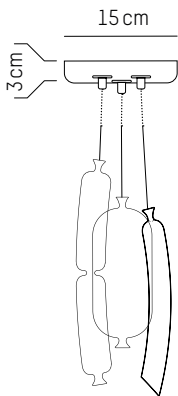

Set of 3 #1

-

Ø: 15 cm | 5.9 inch
H: 33 cm | 13 inch
Cable length: 175 cm | 69 inch
Weight: 1 kg | 2.2 lb

PACKAGING :

L: 49 cm | 19.3 inch
W: 32 cm | 12.6 inch
H: 12 cm | 4.7 inch
Weight: 1,9 kg | 4.2 lb

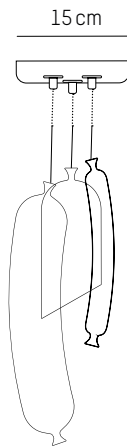

Set of 3 #2

-

Ø: 4,2 cm | 1.7 inch
H: 38 cm | 15 inch
Cable length: 175 cm | 69 inch
Weight: 1,2 kg | 2.7 lb

PACKAGING :

L: 49 cm | 19.3 inch
W: 32 cm | 12.6 inch
H: 12 cm | 4.7 inch
Weight: 1,9 kg | 4.2 lb

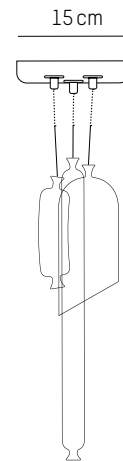

Set of 3 #3

-

Ø: 4,2 cm | 1.7 inch
H: 45 cm | 16.9 inch
Cable length: 175 cm | 69 inch
Weight: 1 kg | 2.2 lb

PACKAGING :

L: 49 cm | 19.3 inch
W: 32 cm | 12.6 inch
H: 12 cm | 4.7 inch
Weight: 1,9 kg | 4.2 lb

SO - SAGE

SAM BARON

2016



Pendant lamp

-

MATERIALS

Pendant: Borosilicate glass; Cable: textile
Ceiling rose : brass graphite finish, steel

COLORS

Clear-transparent

ORIGIN

France

TECHNICAL SPECIFICATIONS

Compatible transformer for variation with trailing edge phase control



Halogen

EUROPE

UK



Power

220-240 V 50-60HZ

Power

220-240 V 50-60 HZ

35

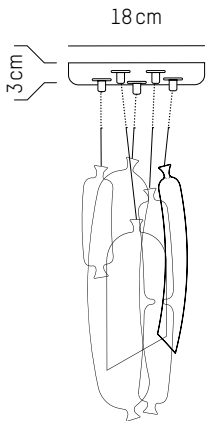

Set of 5

-

Ø: 18 cm | 7.1 inch
H: 38 cm | 15 inch
Cable length : 175 cm | 69 inch
Weight: 1,2 kg | 2.7 lb

PACKAGING :

L: 50 cm | 19.7 inch
W: 45 cm | 17.7 inch
H: 12 cm | 4.7 inch
Weight: 1,9 kg | 4.2 lb

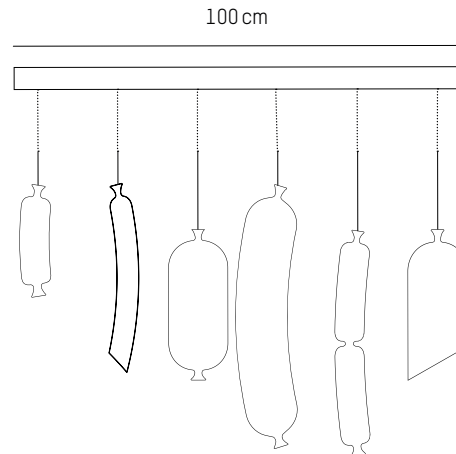

Line of 6

-

L: 100 cm | 39.4 inch
Cable length : 175 cm | 69 inch
Weight: 2,8 kg | 6.2 lb

PACKAGING :

L: 10 cm | 3.9 inch
W: 30 cm | 11.8 inch
H: 11 cm | 4.3 inch
Weight: 4,3 kg | 9.5 lb

TIDELIGHT

PIERRE FAVRESSE

2012



Table Lamp

-

MATERIALS

Lampshade : Blown glass; Base : cork

COLORS

Clear-transparent, smoked

ORIGIN

France

TECHNICAL SPECIFICATIONS



EUROPE

UK



Power

220-240 V 50-60HZ

Power

220-240 V 50-60 HZ

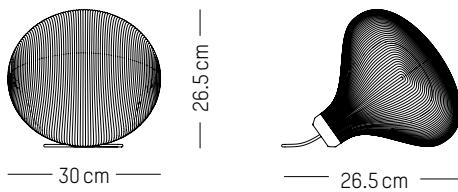

Ø: 30 cm | 11.8 inch
W: 26,5 cm | 10.4 inch
H: 26,5 cm | 10.4 inch
Cable length : 180 cm | 70.8 inch
Weight: 2 kg | 4.4 lb

PACKAGING :

W: 37 cm | 14.6 inch
H: 37,5 cm | 14.8 inch
Weight: 2,7 kg | 6 lb

VERTIGO

CONSTANCE GUISET

2010



Black



Green



Copper



White



Cobalt



Beetle

Pendant lamps

-

MATERIALS

Pendant: Fiberglass, lacquered steel, polyurethane ribbons

Cable: mesh textile; Ceiling rose and socket: plastic

COLORS

Black, Green, Copper, White, Cobalt, Beetle

ORIGIN

France

TECHNICAL SPECIFICATIONS



EUROPE

UK

US



Power

220-240 V 50-60HZ

Power

220-240 V 50-60 HZ

Power

110-120 V 60 HZ

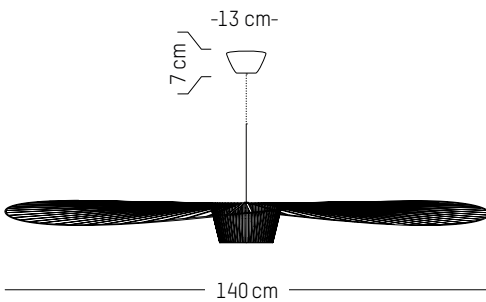

Small

-

Ø: 140 cm | 55 inch

Weight: 0,5 kg | 1 lb

Cable length: 250 cm | 99 inch or
on demand: 1000 cm | 394 inch

PACKAGING :

Type: Carton box

L: 72,5 cm | 28.5 inch

W: 72,5 cm | 28.5 inch

H: 21 cm | 8 inch

Weight: 2,28 | 5 lb

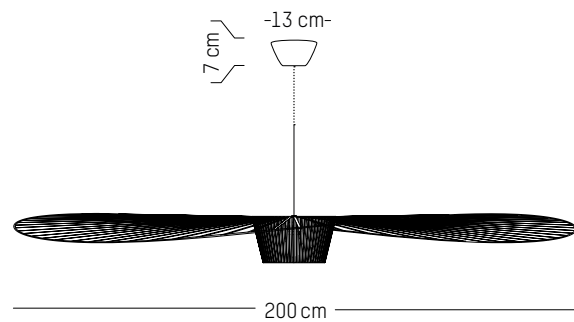

Large

-

Ø: 200 cm | 79 inch

Weight: 0,5 kg | 1 lb

Cable length: 250 cm | 99 inch or
on demand: 1000 cm | 394 inch

PACKAGING :

Type: Carton box

L: 72,5 cm | 28.5 inch

W: 72,5 cm | 28.5 inch

H: 21 cm | 8 inch

Weight: 2,28 | 5 lb

FURNITURE



FRANCIS

CONSTANCE GUISET

2011



Black & Blue-purple watercolor



Black & Pink watercolor

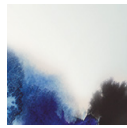

Black & Blue watercolor



White & Green watercolor

S, L

XL

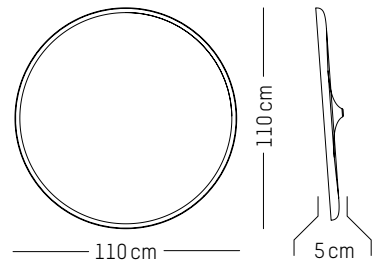
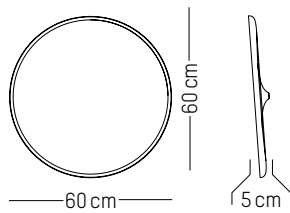
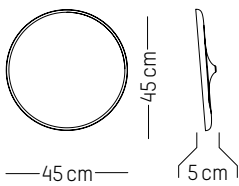

Small

Ø: 45 cm | 17.7 inch
D: 5 cm | 2 inch
Weight: 3.5 kg | 7.7 lb

PACKAGING :

Type: Carton box
L: 52 cm | 20.5 inch
W: 52 cm | 20.5 inch
H: 11 cm | 4.3 inch
Weight: 3 kg | 6.6 lb

Large

Ø: 60 cm | 26.6 inch
D: 5 cm | 2 inch
Weight: 7 kg | 15.4 lb

PACKAGING :

Type: Carton box
L: 68 cm | 26.7 inch
W: 68 cm | 26.7 inch
H: 11 cm | 4.3 inch
Weight: 8,8 kg | 19.4 lb

Extra large

Ø: 110 cm | 43.3 inch
D: 5,5 cm | 2.2 inch
Weight: 23 kg | 50.7 lb

PACKAGING :

Type: Carton box
L: 118 cm | 46.5 inch
W: 118 cm | 46.5 inch
H: 9,5 cm | 3.7 inch
Weight: 28 kg | 11 lb

FRANCIS

CONSTANCE GUISSET

2018



Coffee tables

-

MATERIALS

Mirror
Mirror shell and table leg: Steel with matte grained powder coating

COLORS

Black and blue watercolor, White and green watercolor

ORIGIN

France



Black & Blue watercolor



White & Green watercolor

41

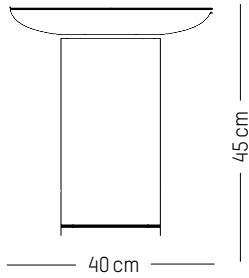

Small

-

D: 40 cm | 15.7 inch
H: 45 cm | 17.5 lb
Weight: 8 kg | 17.6 lb

PACKAGING :

Type: Carton box
L: 52 cm | 20.5 inch
W: 52 cm | 20.5 inch
H: 50 cm | 19.7 inch
Weight: 10 kg | 22 lb

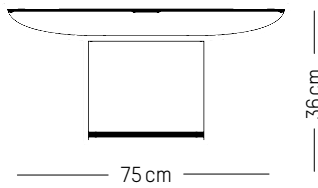

Large

-

D: 75 cm | 29.5 inch
H: 36 cm | 14.2 inch
Weight: 19 kg | 41.9 lb

PACKAGING :

Type: Carton box
L: 86 cm | 33.9 inch
W: 86 cm | 33.9 inch
H: 39 cm | 15.3 inch
Weight: 24 kg | 9.5 lb

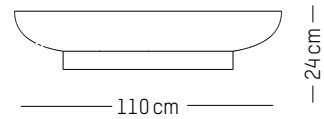

Extra large

-

D: 110 cm | 43.3 inch
H: 24 cm | 9.4 inch
Weight: 45 kg | 99.2 lb

PACKAGING :

Type: Carton box
L: 118 cm | 46.5 inch
W: 118 cm | 46.5 inch
H: 28 cm | 11.2 inch
Weight: 53 kg | 20.9 lb

FROMME

TOM CHUNG

2019



Black



Brown-red



Mint-green



Blue



Coral

Chair

-

MATERIALS

Aluminium, matte grained Anti UV powder coating for outdoor use

COLORS

Black, Brown-red, Mint-green, Blue, Coral

ORIGIN

China

TECHNICAL SPECIFICATIONS

Compliant with EN 581-1 ; EN581-2 for Contract use

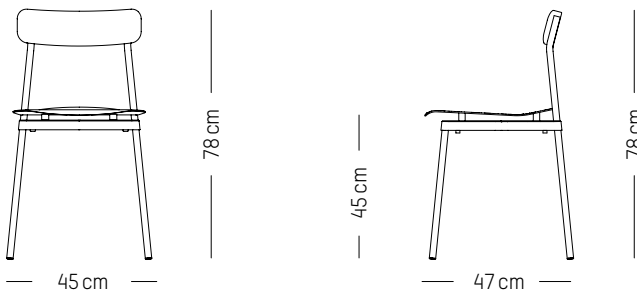

Chair

-

L: 45 cm | 18.5 inch

D: 47 cm | 18.5 inch

H: 78 cm | 30.7 inch

H (seat): 45 cm | 18.5 inch

Weight: 3,3 kg | 7.3 lb

PACKAGING (X2) :

L: 49 cm | 19.3 inch

W: 49 cm | 19.3 inch

H: 79 cm | 31.1 inch

Weight: 9,6 kg | 21.2 lb

FROMME

TOM CHUNG

2021



Black



Brown-red



Mint-green



Blue



Coral

Lounge armchair

-

MATERIALS

Aluminium, matte grained Anti UV powder coating for outdoor use

COLORS

Black, Brown-red, Mint-green, Blue, Coral

ORIGIN

China

TECHNICAL SPECIFICATIONS

Compliant with EN 581-1 ; EN581-2 for Contract use

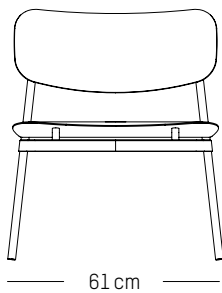

61 cm

71 cm

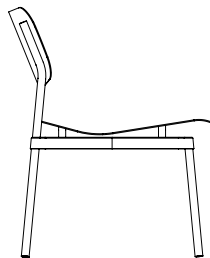

58 cm

40 cm

Lounge armchair

-

L: 61 cm | 24 inch

D: 58 cm | 23 inch

H: 71 cm | 28 inch

H (seat): 40 cm | 16 inch

Weight: 5,9 kg | 13 lb

PACKAGING :

L: 64 cm | 25.2 inch

W: 59 cm | 23.2 inch

H: 71 cm | 28 inch

Weight: 8 kg | 17.6 lb

FROMME

TOM CHUNG

2021



Black



Brown-red



Mint-green



Blue



Coral

Stool

-

MATERIALS

Aluminium, matte grained Anti UV powder coating for outdoor use

COLORS

Black, Brown-red, Mint-green, Blue, Coral

ORIGIN

China

TECHNICAL SPECIFICATIONS

Compliant with EN 581-1 ; EN581-2 for Contract use

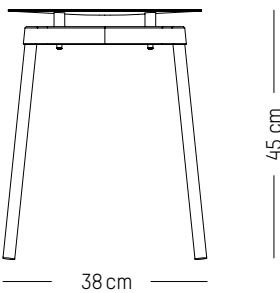

Stool

-

L: 38cm | 15 inch

D: 38 cm | 15 inch

H: 45 cm | 18 inch

Weight: 2,6 kg | 5.7 lb

PACKAGING (X2):

L: 40 cm | 16 inch

W: 40 cm | 16 inch

H: 55 cm | 21.6 inch

Weight: 7 kg | 15.4 lb

FROMME

TOM CHUNG

2021



Black



Brown-red



Mint-green



Blue



Coral

High Stools

-

MATERIALS

Aluminium, matte grained Anti UV powder coating for outdoor use

COLORS

Black, Brown-red, Mint-green, Blue, Coral

ORIGIN

China

TECHNICAL SPECIFICATIONS

Compliant with EN 581-1 ; EN581-2 for Contract use

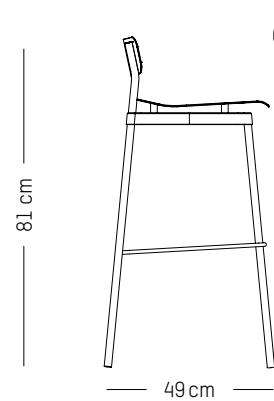
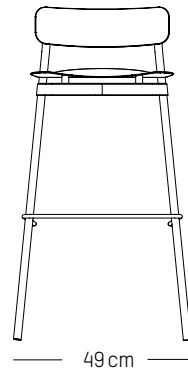
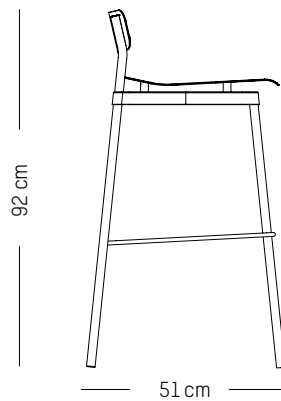
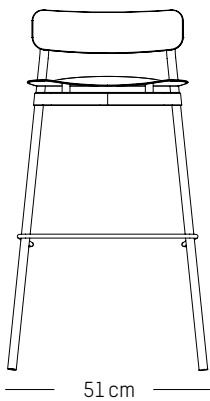

NEW

High stool

-

L: 51cm | 20 inch

D: 51 cm | 20 inch

H: 92 cm | 36 inch

H (seat): 75 cm | 29.5 inch

Weight: 4,5 kg | 9.9 lb

PACKAGING :

L: 53 cm | 20.87 inch

W: 53 cm | 20.87 inch

H: 93 cm | 36. inch

Weight: 6,5 kg | 14.3 lb

High stool

-

L: 49cm | 19.3 inch

D: 49 cm | 19.3 inch

H: 81 cm | 31.9 inch

H (seat): 65 cm | 25.6 inch

Weight: 4,1 kg | 9.1 lb

PACKAGING :

L: 53 cm | 20.9 inch

W: 53 cm | 20.9 inch

H: 83 cm | 32.7 inch

Weight : 4.1 kg | 9.1 lb

FROMME

TOM CHUNG

2021



Square table

-

MATERIALS

Aluminium, matte grained Anti UV powder coating for outdoor use

COLORS

Black, Brown-red, Mint-green, Blue, Coral

ORIGIN

China



Black



Brown-red



Mint-green



Blue



Coral

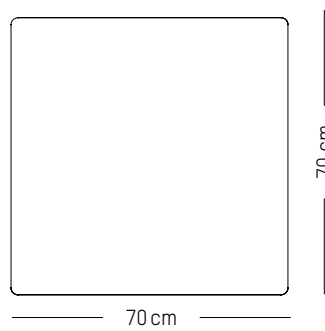
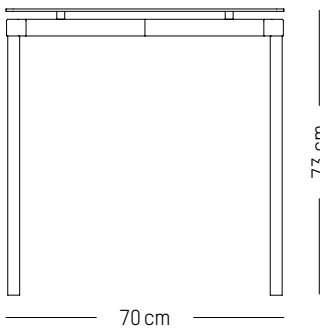

Square table

-

L: 70cm | 28 inch

D: 70 cm | 28 inch

H: 73 cm | 29 inch

Weight: 14,5 kg | 32 lb

PACKAGING :

L: 90 cm | 35.4 inch

W: 72 cm | 28.4 inch

H: 8 cm | 3.2 inch

Weight: 18 kg | 39.7 lb

FROMME

TOM CHUNG

2021



Black



Brown-red



Mint-green



Blue



Coral

Rectangular table

-

MATERIALS

Aluminium, matte grained Anti UV powder coating for outdoor use

COLORS

Black, Brown-red, Mint-green, Blue, Coral

ORIGIN

China

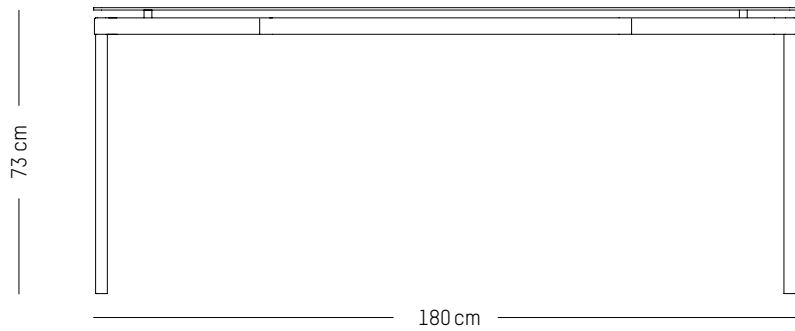
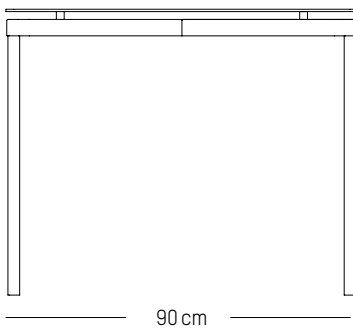

Rectangular table

-

L: 180cm | 70.9 inch

W: 90 cm | 35.4 inch

H: 73 cm | 29 inch

Weight: 37,5 kg | 82.7 lb

PACKAGING :

L: 200 cm | 78.7 inch

W: 92 cm | 36.2 inch

H: 8 cm | 3.2 inch

Weight: 44 kg | 97 lb

FROMME

TOM CHUNG

2022



Coffee table

-

MATERIALS

Aluminium, matte grained Anti UV powder coating for outdoor use

COLORS

Black, Brown-red, Mint-green, Blue, Coral

ORIGIN

China



Black



Brown-red



Mint-green



Blue



Coral

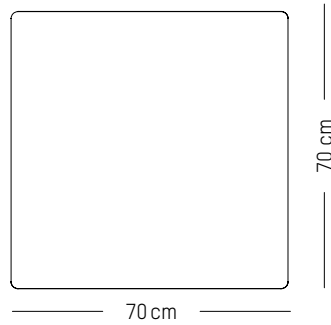
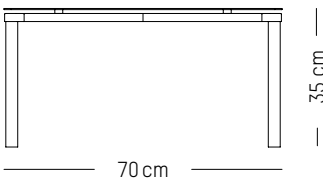

Coffee table

-

L: 70cm | 28 inch

W: 70 cm | 28 inch

H: 35 cm | 13.8 inch

Weight: 12 kg | 26.5 lb

PACKAGING :

L: 88 cm | 34.7 inch

W: 77 cm | 30.3 inch

H: 20 cm | 7.9 inch

Weight: 16 kg | 35.3 lb

FROMME SOFT

TOM CHUNG

2020

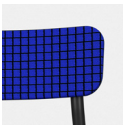

Blue-black



Black-blue

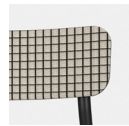

Ecru-black



Black-ecru

Chair

-

MATERIALS

Chair : Aluminium with grained powder coating
PU foam, cover (removable and reversible) polyester knit

COLORS

Black and Black-blue upholstery, Black-blue and black upholstery, Black and ecru-black upholstery, Ecru-black and black upholstery

ORIGIN

China and Europe

Compliant with EN 581-1 ; EN581-2 for Contract use
Removable and reversible knitted cover; Machine washable (40°)
Compliant with EN1021-1 et 1021-2 for Fire resistance

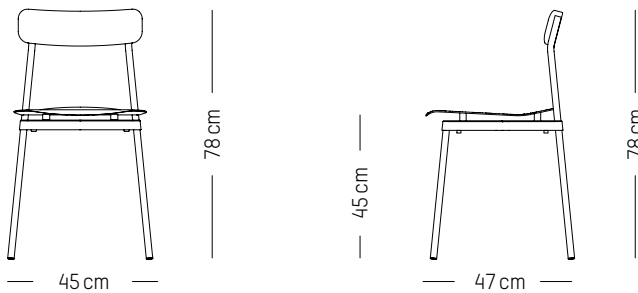

Chair

-

L: 45 cm | 18.5 inch

D: 47 cm | 18.5 inch

H: 78 cm | 30.7 inch

H (seat): 45 cm | 18.5 inch

Weight: 4,8 kg | 10.6 lb

PACKAGING :

L: 50 cm | 19.7 inch

W: 47 cm | 18.5 inch

H: 79 cm | 31.1 inch

Weight: 7 kg | 15.4 lb

FROMME SOFT

TOM CHUNG

2021

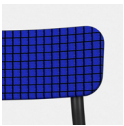

Blue-black



Black-blue

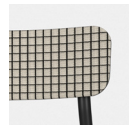

Ecru-black



Black-ecru

Lounge armchair

MATERIALS

Chair : Aluminium with grained powder coating
PU foam, **cover** (removable and reversible) polyester knit

COLORS

Black and Black-blue upholstery, Black-blue and black upholstery, Black and ecru-black upholstery, Ecru-black and black upholstery

ORIGIN

China and Europe

Compliant with EN 581-1 ; EN581-2 for Contract use
Removable and reversible knitted cover; Machine washable (40°)
Compliant with EN1021-1 et 1021-2 for Fire resistance

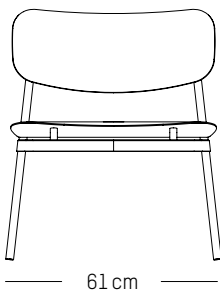

71 cm

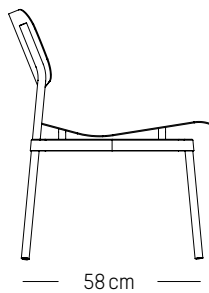

40 cm

Lounge armchair

L: 61cm | 24 inch
D: 58 cm | 23 inch
H: 71 cm | 28 inch
H (seat): 40 cm | 16 inch
Weight: 7,9 kg | 17.4 lb

PACKAGING :

L: 64 cm | 25.2 inch
W: 59 cm | 23.2 inch
H: 71 cm | 28 inch
Weight: 11 kg | 24.3 lb

FROMME SOFT

TOM CHUNG

2020



Blue-black



Black-blue

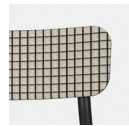

Ecru-black



Black-ecru

High Stools

-

MATERIALS

Chair : Aluminium with grained powder coating
PU foam, cover (removable and reversible) polyester knit

COLORS

Black and Black-blue upholstery, Black-blue and black upholstery, Black and ecru-black upholstery, Ecru-black and black upholstery

ORIGIN

China and Europe

Compliant with EN 581-1 ; EN581-2 for Contract use
Removable and reversible knitted cover; Machine washable (40°)
Compliant with EN1021-1 et 1021-2 for Fire resistance

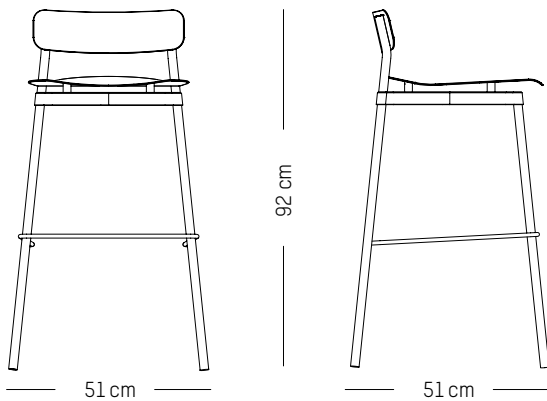

High stool

-

L: 51cm | 20.4 inch
D: 51 cm | 20.1 inch
H: 92 cm | 36.2 inch
H (seat): 75 cm | 29.5 inch
Weight: 6 kg | 13.2 lb

PACKAGING :

L: 53 cm | 20.87 inch
W: 53 cm | 20.87 inch
H: 93 cm | 36.6 inch
Weight: 10 kg | 22 lb

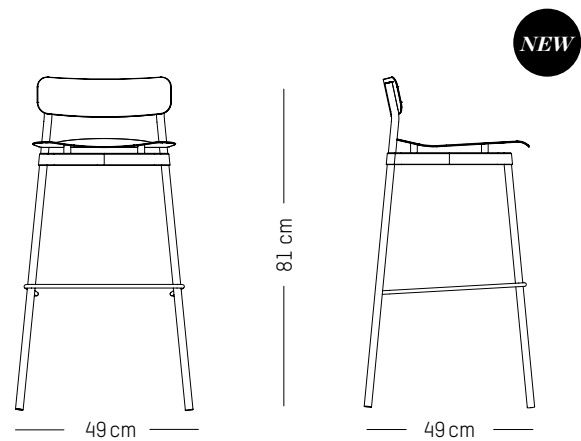

High stool

-

L: 49cm | 19.3 inch
D: 49 cm | 19.3 inch
H: 81 cm | 31.9 inch
H (seat): 65 cm | 25.6 inch
Weight: 4,1 kg | 9.1 lb

PACKAGING :

L: 53 cm | 20.9 inch
W: 53 cm | 20.9 inch
H: 83 cm | 32.7 inch
Weight: 4.1 kg | 9.1 lb

HOLLO

AC/AL STUDIO

2012



Black



Anthracite



Gold

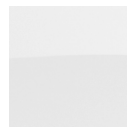

White



Burgundy



Blue

Stool and tables

-

MATERIALS

Steel with matte grained powder coating

COLORS

Black, Anthracite, Gold, White, Burgundy, Blue

ORIGIN

Europe

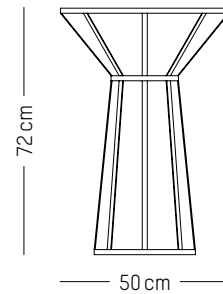
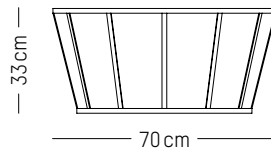
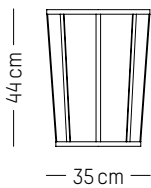

Stool

-

Ø: 35 cm | 14 inch
H: 44 cm | 17.3 inch
Weight: 4 kg | 8.8 lb

PACKAGING :

Type: Carton box
L: 41,5 cm | 16.3 inch
W: 41 cm | 16.1 inch
H: 52 cm | 20.5 inch
Weight: 5,6 kg | 12.3 lb

Coffee table

-

Ø: 70 cm | 27.6 inch
H: 33 cm | 13 inch
Weight: 12 kg | 2.2 lb

PACKAGING :

Type: Carton box
L: 76 cm | 29.9 inch
W: 74,5 cm | 29.3 inch
H: 40 cm | 15.8 inch
Weight: 15,3 kg | 33.7 lb

Bistro table

-

Ø: 50 cm | 28.4 inch
H: 72 cm | 19.7 inch
Weight: 7 kg | 15.4 lb

PACKAGING :

Type: Carton box
L: 56 cm | 22.1 inch
W: 56 cm | 22.1 inch
H: 78 cm | 30.7 inch
Weight: 11,1 kg | 24.5 lb

ISO

STUDIO POOL

2014



Black



White



Burgundy



Blue

Side tables

-

MATERIALS

Steel with matte grained powder coating

COLORS

Black, White, Burgundy, Blue

ORIGIN

Europe

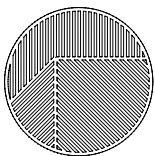

Ø 47 cm

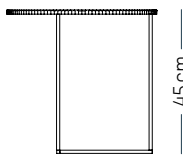

— 47 cm —

45 cm

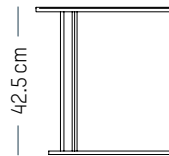

42,5 cm

— 40 cm —

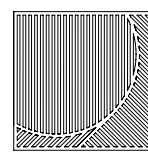

— 40 cm —

40 cm

ISO-A

-

Ø: 47 cm | 18.5 inch
H: 45 cm | 17.7 inch
Weight: 5 kg | 11 lb

PACKAGING :

Type: Carton box
L: 52 cm | 20.5 inch
W: 51 cm | 20.1 inch
H: 50 cm | 19.7 inch
Weight: 7,8 kg | 17.2 lb

ISO-B

-

L: 40 cm | 15.8 inch
W: 40 cm | 15.8 inch
H: 42,5 cm | 16.7 inch
Weight: 5 kg | 11 lb

PACKAGING :

Type: Carton box
L: 52 cm | 20.5 inch
W: 51 cm | 20.1 inch
H: 50 cm | 19.7 inch
Weight: 7,8 kg | 17.2 lb

PARROT

INDIA MAHDAVI

2015



Light pink

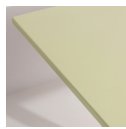

Light yellow



Turquoise



Cream-pink
Pattern



Light green-
Dark green
Pattern

Tables

-

MATERIALS

Plate : Enameled steel; Leg structure : steel, with smooth powder coating

COLORS

Light pink, Light yellow, Turquoise, Cream-pink patter, Light green-dark green patter

ORIGIN

France and Portugal

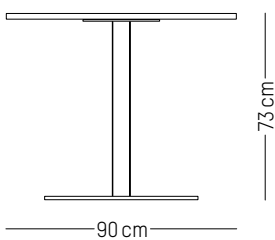

Small

-

L: 90 cm | 35.4 inch
W: 90 cm | 35.4 inch
H: 73 cm | 28.7 inch
POIDS: 39 kg | 86 lb

PACKAGING :

L: 100 cm | 39.4 inch
W: 100 cm | 39.4 inch
H: 80 cm | 31.5 inch
Weight: 55 kg | 121 lb

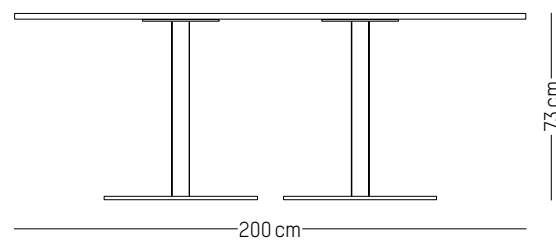

Large

-

L: 200 cm | 78.9 inch
W: 90 cm | 35.4 inch
H: 73 cm | 28.7 inch
Weight: 80 kg | 176.4 lb

PACKAGING :

L: 210 cm | 82.7 inch
W: 100 cm | 39.4 inch
H: 80 cm | 31.5 inch
Weight: 95 kg | 209 lb

TAVLA

STUDIO POOL

2020



Black and natural

Dining tables

-

MATERIALS

Wooden top with marquetry/inlay of natural & black walnut veneers; Legs in steel with matte grained powder coating

COLORS

Black and natural

ORIGIN

Europe

TECHNICAL SPECIFICATIONS

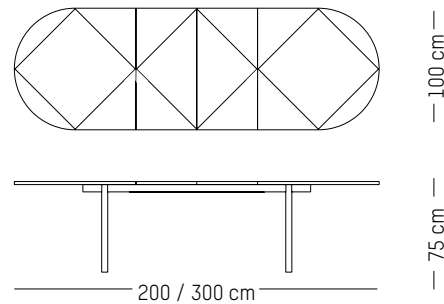
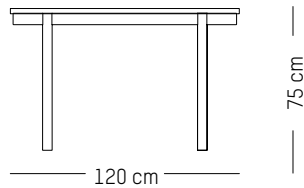
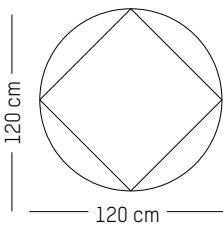

Round

-

Ø: 120 cm | 47.2 inch
H: 75 cm | 29.5 inch
Weight: 32 kg | 70.5 lb

PACKAGING :

L: 150 cm | 59 inch
L: 150 cm | 59 inch
H: 15 cm | 6 inch
Weight: 55 kg | 121.3 lb

Assembly

Extendable oval

-

L: 200/300 cm - 2 extensions of 50cm
28.5 inch - 2 extensions of 19.6 inch
W: 100 cm | 39.3 inch
H: 75 cm | 29.5 inch
Weight: 60kg | 132.2 lb

PACKAGING :

Type : Wood box
L: 215 cm | 85 inch
W: 110 cm | 43.3 inch
H: 15 cm | 6 inch
Weight: 95 kg | 209.5 lb

Assembly

TAVLA

STUDIO POOL

2020



Black and natural

Coffee table

-

MATERIALS

Wooden top with marquetry/inlay of natural & black walnut veneers; Legs in wood with black walnut veneer

COLORS

Black and natural

ORIGIN

Europe

TECHNICAL SPECIFICATIONS

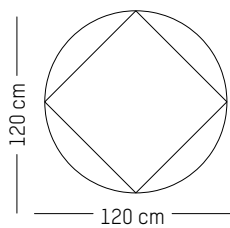

Round Coffee table

-

Ø: 120 cm | 47.2 inch

H: 25 cm | 9.8 inch

Weight: 40 kg | 88.2 lb

PACKAGING :

L: 150 cm | 59 inch

L: 150 cm | 59 inch

H: 40 cm | 15.7 inch

Weight: 50 kg | 110 lb

Assembly

TAVLA

STUDIO POOL

2020



Black



Coral



Blue



Mint green

FOR CONTRACT PROJECT WITH MINIMUM QUANTITY

Bistro tables

-

MATERIALS

Wooden top with marquetry/inlay of natural & black walnut veneers; Legs in steel with matte grained powder coating

COLOURS

Black and natural wooden top

Leg: black, coral, blue, mint green

ORIGIN

Europe

TECHNICAL SPECIFICATIONS

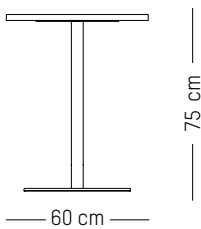
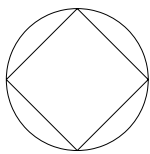

Round bistro small

-

Ø: 60 cm | 23.6 inch

H: 75 cm | 29.5 inch

Weight: 19,9 kg | 43.9 lb

PACKAGING :

L: 80 cm | 31,5 inch

L: 65 cm | 25,6 inch

H: 7 cm | 2.8 inch

Weight: 21 kg | 46.3 lb

Assembly

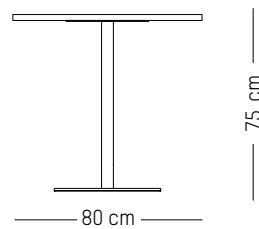
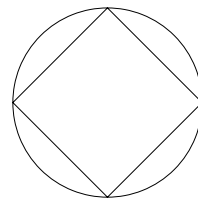

Round bistro large

-

Ø: 80 cm | 31.5 inch

H: 75 cm | 29.5 inch

Weight: 22,4 kg | 49.4 lb

PACKAGING :

L: 80 cm | 31,5 inch

L: 85 cm | 33,5 inch

H: 7 cm | 2.8 inch

Weight: 24 kg | 53 lb

Assembly

TAVLA

STUDIO POOL

2020

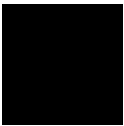

Black



Coral



Blue



Mint green

FOR CONTRACT PROJECT WITH MINIMUM QUANTITY

Bistro tables

-

MATERIALS

Wooden top with marquetry/inlay of natural & black walnut veneers; Legs in steel with matte grained powder coating

COLOURS

Black and natural wooden top

Leg: black, coral, blue, mint green

ORIGIN

Europe

TECHNICAL SPECIFICATIONS



58

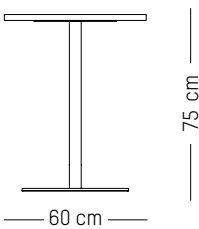
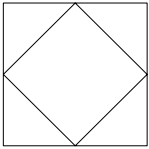

Square bistro small

-

L: 60 cm | 23.6 inch

W: 60 cm | 23.6 inch

H: 75 cm | 29.5 inch

Weight: 21,7 kg | 47.9 lb

PACKAGING :

L: 80 cm | 31,5 inch

L: 65 cm | 25,6 inch

H: 7 cm | 2.8 inch

Weight: 23 kg | 51 lb

Assembly

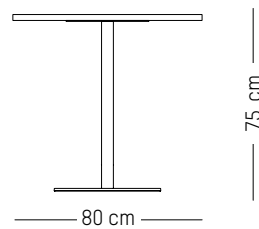
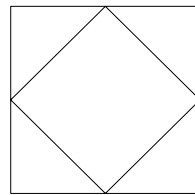

Square bistro large

-

L: 80 cm | 31.5 inch

W: 80 cm | 31.5 inch

H: 75 cm | 29.5 inch

Weight: 25,2 kg | 55.6 lb

PACKAGING :

L: 80 cm | 31,5 inch

L: 85 cm | 33,5 inch

H: 7 cm | 2.8 inch

Weight: 27 kg | 60 lb

Assembly

TAVLA

STUDIO POOL

2020



Black

Coral

Blue

Mint green

FOR CONTRACT PROJECT WITH MINIMUM QUANTITY

High tables

-

MATERIALS

Wooden top with marquetry/inlay of natural & black walnut veneers; Legs in steel with matte grained powder coating

COLOURS

Black and natural wooden top
Leg: black, coral, blue, mint green

ORIGIN

Europe

TECHNICAL SPECIFICATIONS

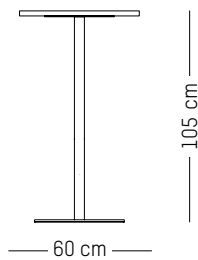
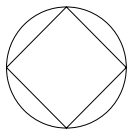

Round high

-

Ø: 60 cm | 23.6 inch
H: 105 cm | 41.34 inch
Weight: 20,6 kg | 45.4 lb

PACKAGING :

L: 110 cm | 43,3 inch
L: 65 cm | 25,6 inch
H: 7 cm | 2.8 inch
Weight: 22 kg | 48.5 lb

Assembly

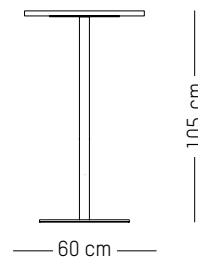
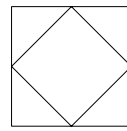

Square high

-

L: 60 cm | 23.6 inch
W: 60 cm | 23.6 inch
H: 105 cm | 41.34 inch
Weight: 22,5 kg | 49.6 lb

PACKAGING :

L: 110 cm | 43,3 inch
L: 65 cm | 25,6 inch
H: 7 cm | 2.8 inch
Weight: 24 kg | 53 lb

Assembly

TRAME*

AC/AL STUDIO

2014



Black



Anthracite*



White

Chair

-

MATERIALS

Steel with matte grained powder coating

COLORS

Black, Anthracite, White

ORIGIN

Europe

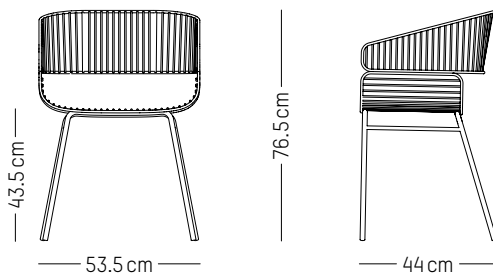

L: 53,5 cm | 21 inch
D: 44 cm | 17.3 inch
H: 76,5 cm | 30.1 inch
H (seat): 43,5 cm | 17.1 inch
Weight: 8 kg | 17.6 lb

PACKAGING :

L: 80 cm | 31.5 inch
W: 60 cm | 23.6 inch
H: 52 cm | 20.5 inch
Weight: 9,8 kg | 21.6 lb

* While stocks last

TRAME

AC/AL STUDIO

2014

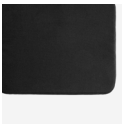

Black

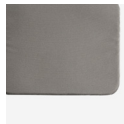

Grey



White

Cushions

-

MATERIALS

Cover in acrylic, quickdry foam in polyethylene

COLORS

Black, Grey, White

ORIGIN

France

TECHNICAL SPECIFICATIONS

Suitable for outdoor use

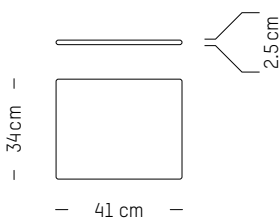

Seat cushion

-

L: 41 cm | 16.1 inch
W: 34 cm | 13.4 inch
H: 2,5 cm | 1 inch
Weight: 0,5 kg | 1.1 lb

PACKAGING :

L: 45 cm | 17.7 inch
W: 45 cm | 17.7 inch
H: 5 cm | 2 inch
Weight: 1 kg | 2.2 lb

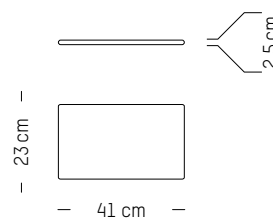

Back cushion

-

L: 41 cm | 16.1 inch
W: 23 cm | 9.1 inch
H: 2,5 cm | 1 inch
Weight: 0,5 kg | 1.1 lb

PACKAGING :

L: 45 cm | 17.7 inch
W: 45 cm | 17.7 inch
H: 5 cm | 2 inch
Weight: 1 kg | 2.2 lb

UNIFY

ANNE HARVALA

2020



Side table

-

MATERIALS

Wooden top with matte lacquered oak veneer
Leg structure : Steel with matte grained powder coating

COLORS

Grey-brown, Red-brown, Blush

ORIGIN

Europe

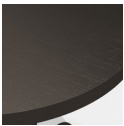

Grey-brown

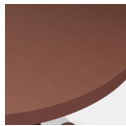

Red-brown

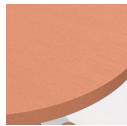

Blush

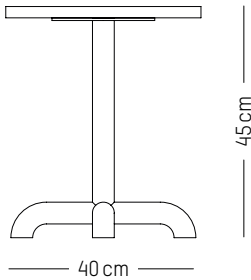

Ø: 40 cm | 15.7 inch
H: 45 cm | 17.7 inch
Weight: 5 kg | 11 lb

PACKAGING :

L: 42 cm | 16.5 inch
W: 42 cm | 16.5 inch
H: 47 cm | 18.5 inch
Weight: 7 kg | 15 lb

UNIFY

ANNE HARVALA

2020



Grey-brown

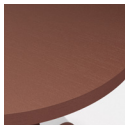

Red-brown

Round dining table

-

MATERIALS

Wooden top with matte lacquered oak veneer
Leg structure : Steel with matte grained powder coating

COLORS

Red-brown, Grey-brown

ORIGIN

Europe

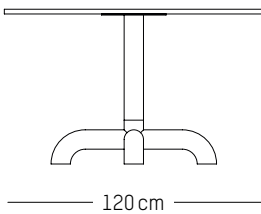

Round dining table

-

Ø: 120 cm | 47.2 inch
H: 73 cm | 29 inch
Weight: 33 kg | 72.5 lb

PACKAGING :

- Carton box 1
L: 122 cm | 48 inch
W: 122 cm | 48 inch
H: 30 cm | 11.8 inch
Weight: 20 cm | 44 inch

- Carton box 2
L: 60 cm | 23.6 inch
W: 60 cm | 23.6 inch
H: 25 cm | 9.8 inch
Weight: 18 kg | 39.7 lb

Assembly

UNIFY

ANNE HARVALA

2020



Rectangular dining table

-

MATERIALS

Wooden top with matte lacquered oak veneer
Leg structure : Steel with matte grained powder coating

COLORS

Grey-brown, Red-brown

ORIGIN

Europe



Grey-brown

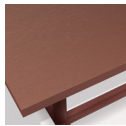

Red-Brown

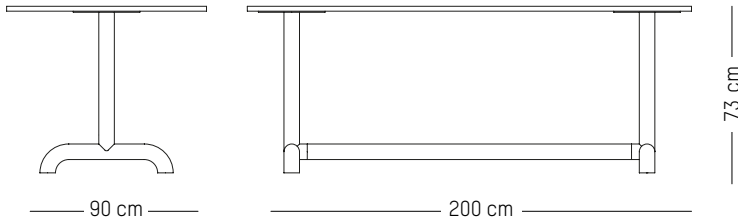

Rectangular dining table

-

L: 200 cm | 79 inch
W: 90 cm | 35 inch
H: 73 cm | 29 inch
Weight: 46 kg | 102 lb

PACKAGING :

- Carton box 1
L: 202 cm | 79 inch
W: 92 cm | 36 inch
H: 5 cm | 2 inch
Weight: 30 kg | 66.1 lb

- Carton box 2
L: 180 cm | 71 inch
W: 62 cm | 24 inch
H: 16 cm | 6.3 inch
Weight: 22 kg | 48.5 lb

Assembly

UNIFY

ANNE HARVALA

2020



Grey-brown

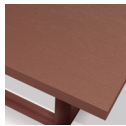

Red-Brown

Benches

-

MATERIALS

Wooden top with matte lacquered oak veneer
Leg structure : Steel with matte grained powder coating

COLORS

Grey-brown, Red-brown

ORIGIN

Europe

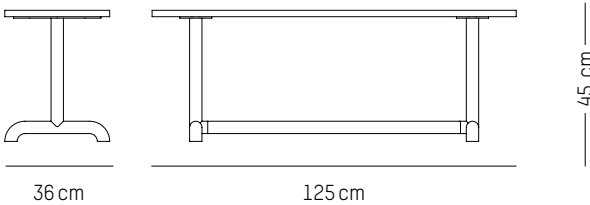

Bench 125 cm

-

L: 125 cm | 49.2 inch
W: 36 cm | 14.2 inch
H: 45 cm | 17.7 inch
Weight: 15 kg | 33 lb

PACKAGING :

- Carton box 1
L: 127 cm | 50 inch
W: 38 cm | 15 inch
H: 11 cm | 4.3 inch
Weight: 10 kg | 22 inch

- Carton box 2
L: 127 cm | 50 inch
W: 38 cm | 15 inch
H: 3 cm | 1.2 inch
Weight: 8 kg | 17.6 lb

Assembly

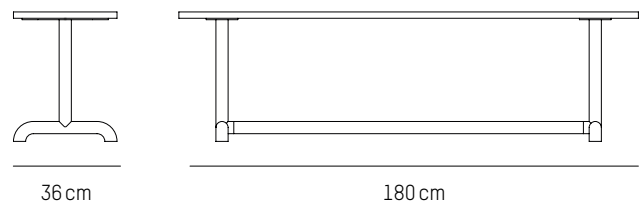

Bench 180 cm

-

L: 180 cm | 71 inch
W: 36 cm | 14.2 inch
H: 45 cm | 17.7 inch
Weight: 21 kg | 46.3 lb

PACKAGING :

- Carton box 1
L: 182 cm | 71.7 inch
W: 38 cm | 15 inch
H: 11 cm | 4.3 inch
Weight: 13 kg | 28.7 inch

- Carton box 2
L: 182 cm | 71.7 inch
W: 38 cm | 15 inch
H: 3 cm | 1.2 inch
Weight: 11 kg | 24.3 lb

Assembly

UNIFY

ANNE HARVALA

2020

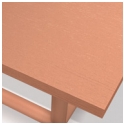

Blush

FOR CONTRACT PROJECT WITH MINIMUM QUANTITY

Benches

-

MATERIALS

Wooden top with matte lacquered oak veneer
Leg structure : Steel with matte grained powder coating

COLOURS

Blush

ORIGIN

Europe

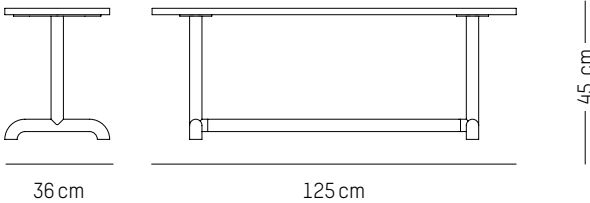

Bench 125 cm

-

L: 125 cm | 49.2 inch
W: 36 cm | 14.2 inch
H: 45 cm | 17.7 inch
Weight: 15 kg | 33 lb

PACKAGING :

- Carton box 1
L: 127 cm | 50 inch
W: 38 cm | 15 inch
H: 11 cm | 4.3 inch
Weight: 10 cm | 22 inch

- Carton box 2
L: 127 cm | 50 inch
W: 38 cm | 15 inch
H: 3 cm | 1.2 inch
Weight: 8 kg | 17.6 lb

Assembly

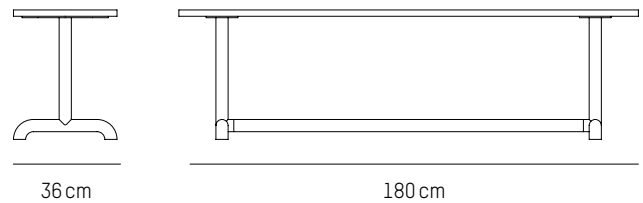

Bench 180 cm

-

L: 180 cm | 71 inch
W: 36 cm | 14.2 inch
H: 45 cm | 17.7 inch
Weight: 21 kg | 46.3 lb

PACKAGING :

- Carton box 1
L: 182 cm | 71.7 inch
W: 38 cm | 15 inch
H: 11 cm | 4.3 inch
Weight: 13 cm | 28.7 inch

- Carton box 2
L: 182 cm | 71.7 inch
W: 38 cm | 15 inch
H: 3 cm | 1.2 inch
Weight: 11 kg | 24.3 lb

Assembly

UNIFY

ANNE HARVALA

2020

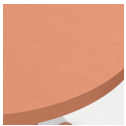

Blush

FOR CONTRACT PROJECT WITH MINIMUM QUANTITY

Round dining table

-

MATERIALS

Wooden top with matte lacquered oak veneer
Leg structure : Steel with matte grained powder coating

COLOURS

Blush

ORIGIN

Europe

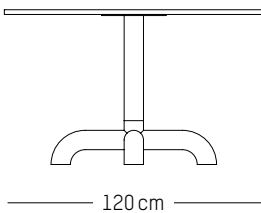

Round dining table

-

Ø: 120 cm | 47.2 inch
H: 73 cm | 29 inch
Weight: 33 kg | 72.5 lb

PACKAGING :

- Carton box 1
L: 122 cm | 48 inch
W: 122 cm | 48 inch
H: 30 cm | 11.8 inch
Weight: 20 kg | 44 lb

- Carton box 2
L: 60 cm | 23.6 inch
W: 60 cm | 23.6 inch
H: 25 cm | 9.8 inch
Weight: 18 kg | 39.7 lb

Assembly

UNIFY

FOR CONTRACT PROJECT WITH MINIMUM QUANTITY

ANNE HARVALA

2020



Rectangular dining table

-

MATERIALS

Wooden top with matte lacquered oak veneer
Leg structure : Steel with matte grained powder coating

COLOURS

Blush

ORIGIN

Europe

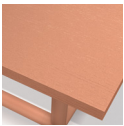

Blush

68

13

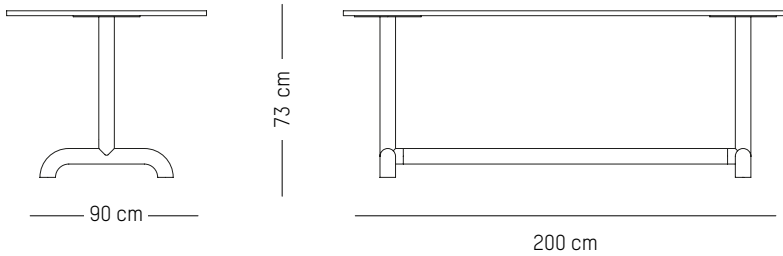

Rectangular dining table

-

L: 200 cm | 79 inch
W: 90 cm | 35 inch
H: 73 cm | 29 inch
Weight: 46 kg | 102 lb

PACKAGING :

- Carton box 1
L: 202 cm | 79.53 inch
W: 92 cm | 36.22 inch
H: 5 cm | 2 inch
Weight: 30 kg | 66.1 lb

- Carton box 2
L: 80 cm | 31.5 inch
W: 62 cm | 24.41 inch
H: 16 cm | 6.30 inch
Weight: 22kg | 48.5 lb

Assembly

UNIFY

ANNE HARVALA

2020

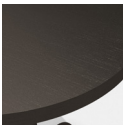

Grey-brown

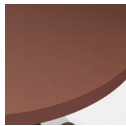

Red-Brown

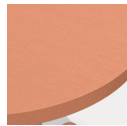

Blush

FOR CONTRACT PROJECT WITH MINIMUM QUANTITY

Bistro round table

-

MATERIALS

Wooden top with matte lacquered oak veneer

Leg structure : Steel with matte grained powder coating

COLOURS

Grey-brown, Red-brown, Blush

ORIGIN

Europe

TECHNICAL SPECIFICATIONS

Adjustable feet

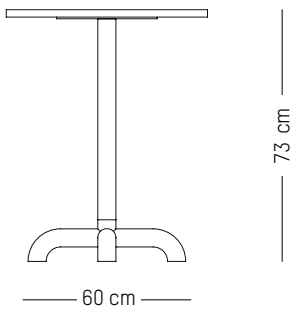

Round bistro table

-

Ø: 60 cm | 23.6 inch

H: 73 cm | 29 inch

Weight: 11 kg | 24.2 lb

PACKAGING :

L: 62 cm | 24.4 inch

W: 62 cm | 23.6 inch

H: 20 cm | 7.8 inch

Weight: 13 kg | 28.7 lb

Assembly

UPHOLSTERY

LILY

FÄRG & BLANCHE

2022



Sofa and armchair

MATERIALS

Steel frame and ply, steel springs, 100% polyurethane fire-proof HR foam.

COLORS

4 collections of fabric available.
See our upholstery collections brochure.

ORIGIN

Europe

Lily armchairs and sofas are manufactured to order.

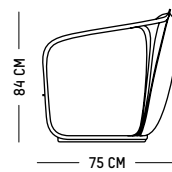
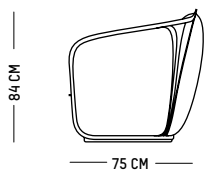
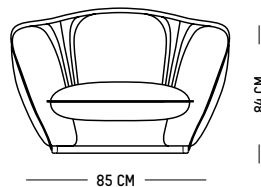
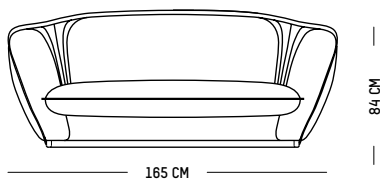

Sofa

L: 165 cm | 65 inch
W: 75 cm | 30 inch
H: 84 cm | 33 inch
Weight: 59 kg | 130 lb

PACKAGING :

Type: Wooden crate
L: 172 cm | 68 inch
W: 85 cm | 33 inch
H: 102 cm | 40 inch
Weight: 90kg | 198 lb

Armchair

L: 85 cm | 33 inch
W: 75 cm | 30 inch
H: 84 cm | 33 inch
H1: 40 cm | 15.7 inch
Weight: 39 kg | 86 lb

PACKAGING :

Type: Wood box
L: 92 cm | 36 inch
W: 85 cm | 33 inch
H: 102 cm | 40 inch
Weight: 60 kg | 132 lb



Sofa and armchair

MATERIALS

Steel with matte grained powder coating + oak wood
Seat and back foam: 100% PU foam 80g/m2
 Cushion in mix of PU and wadding, fabric to be chosen by client

ORIGIN

Europe

TECHNICAL SPECIFICATIONS

Removable cushions

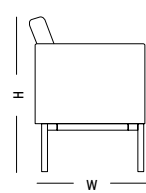
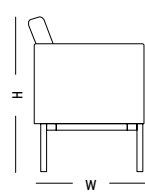
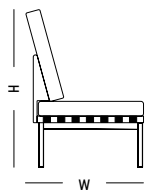
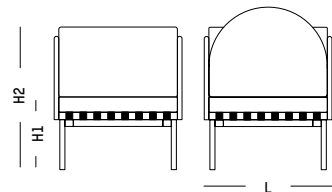
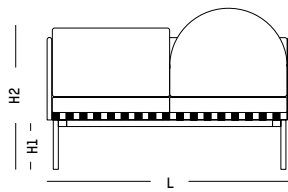
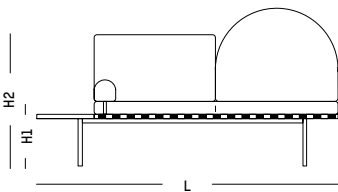

Daybed

L: 187 cm | 73.6 inch
W: 71 cm | 28 inch
H: 92 cm | 36.2 inch
H1: 45 cm | 17.7 inch
Weight: 45 kg | 92.2 lb

PACKAGING :

Type: Wood box
L: 170 cm | 66.9 inch
W: 90 cm | 35.4 inch
H: 100 cm | 39.4 inch
Weight: 90 kg | 198 lb

Options : round cushion, square cushion, headrest, walnut wood

Sofa with 2 armrests

L: 146 cm | 57.5 inch
W: 71 cm | 28 inch
H: 92 cm | 36.2 inch
H1: 45 cm | 17.7 inch
H2: 86 cm | 33.9 inch
Weight: 50 kg | 110.2 lb

PACKAGING :

Type: Wood box
L: 170 cm | 66.9 inch
W: 90 cm | 35.4 inch
H: 100 cm | 39.4 inch
Weight: 95 kg | 209 lb

Options : round cushion, square cushion, walnut wood
 1 or 2 armrest

Armchair with 2 armrests

L: 76 cm | 30 inch
W: 71 cm | 28 inch
H: 92 cm | 36.2 inch
H1: 45 cm | 17.7 inch
H2: 86 cm | 33.9 inch
Weight: 34 kg | 75 lb

PACKAGING :

Type: Wood box
L: 146 cm | 57.5 inch
W: 88 cm | 34.6 inch
H: 100 cm | 39.4 inch
Weight: 70 kg | 154 lb

Options : round cushion, square cushion, walnut wood
 1 or 2 armrest

GRID

STUDIO POOL

2016



Stool and coffee table

-

MATERIALS

Steel with matte grained powder coating + oak wood

Seat and back foam: 100% PU foam 80g/m²

Cushion in mix of PU and wadding, fabric to be chosen by client

ORIGIN

Europe

TECHNICAL SPECIFICATIONS

Removable cushions

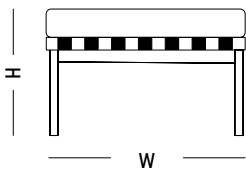

Stool

-

L : 68 cm | 27 inch

W : 68 cm | 27 inch

H : 45 cm | 18 inch

Weight : 17 kg | 38 lb

PACKAGING :

Type : Wood box

L : 90 cm | 36 inch

W : 88 cm | 35 inch

H : 100 cm | 40 inch

Weight : 55 kg | 122 lb

Options : walnut wood

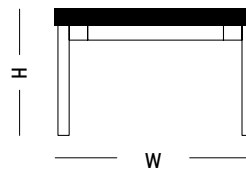

Coffee table

-

L : 68 cm | 27 inch

W : 68 cm | 27 inch

H : 33 cm | 12 inch

Weight : 21 kg | 47 lb

PACKAGING :

Type : Wood box

L : 90 cm | 36 inch

W : 88 cm | 35 inch

H : 100 cm | 40 inch

Weight : 60 kg | 133 lb

Options : walnut wood

GRID - PRE-COMPOSED FABRIC SELECTION

SELECTED FABRICS

1/ CHOOSE MODULES

2/ FABRICS : SHADES OF GREY

Grey-black



Base
Cat.2
FIELD 2 - 182



Round cushion
Cat.2
VITA NOIR ITA12



Headrest
Cat.2
VITA NOIR ITA12

Grey-blue



Base
Cat.3
FIELD 2 - 222



Round cushion
Cat.2
VITA SWAN ITA42



Headrest
Cat.2
VITA SWAN ITA42

Grey-beige



Base
Cat.3
FIELD 2 - 123



Round cushion
Cat.2
VITA ALPACA ITA46



Headrest
Cat.2
VITA ALPACA ITA46

3/ WOOD, METAL AND OPTIONS



Oak Wood
already included



EXAMPLES OF MODULAR ASSEMBLY : GRID modules allow to create multiple configurations to equip entire lounge spaces.



**2 seater sofa without armrest
+ armchair without armrest**

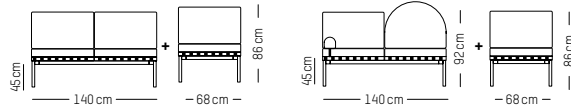

**2 seater sofa without armrest
+ armchair with 1 armrest**

(right or left)

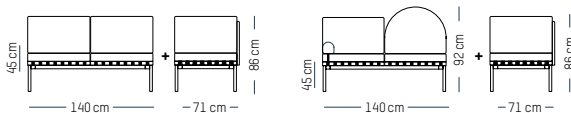

**2 seater sofa without armrest
+ 2 armchairs with 1 armrest**

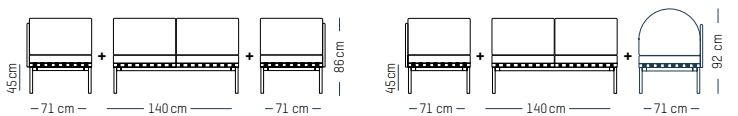

**2 seater sofa without armrest
+ 1 armchair with 1 armrest + 1 pouf**

(right or left)

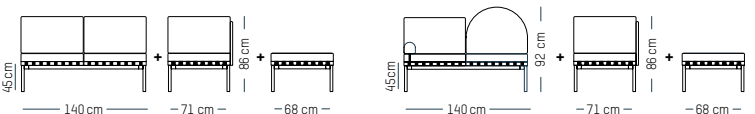

**Armchairs and Stools**

-

MATERIALS

Steel with matte grained powder coating

Seat and back foam: PU foam 40kg/m³ + wadding 100% PE 80g/m²**Cover:** fabric to be chosen by client (non removable covers).**ORIGIN**

Europe

TECHNICAL SPECIFICATIONS

DRY CLEAN

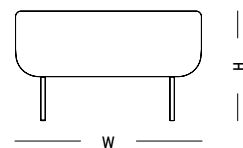
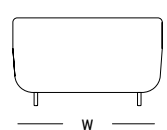
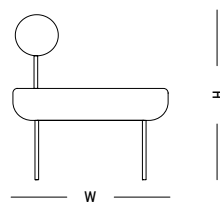
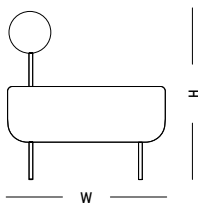
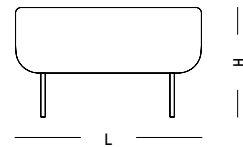
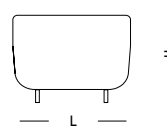
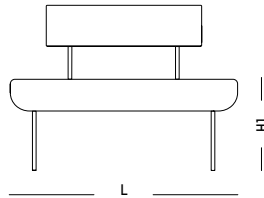
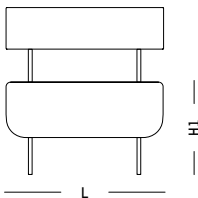
**Medium Armchair**

-

L: 68 cm | 26.8 inch
W: 68 cm | 26.8 inch
H: 72.5 cm | 28.5 inch
H1: 40 cm | 15.8 inch
Weight: 17 kg | 37.5 lb

PACKAGING :

Type: Wood box
L: 53cm | 20.9 inch
W: 71cm | 27.9 inch
H: 43 cm | 16.9 inch
Weight: 24 kg | 12.6 lb

Large Armchair

-

L: 99,5 cm | 39.2 inch
W: 68 cm | 26.8 inch
H: 72.5 cm | 28.5 inch
H1: 40 cm | 15.8 inch
Weight: 18 kg | 39.7 lb

PACKAGING :

Type: Wood box
L: 103cm | 40.5 inch
W: 71cm | 27.9 inch
H: 76 cm | 29.9 inch
Weight: 31 kg | 68 lb

Small Stool

-

L: 50 cm | 19.7 inch
W: 68 cm | 26.8 inch
H: 40 cm | 15.8 inch
Weight: 14 kg | 30.9 lb

PACKAGING :

Type: Wood box
L: 53cm | 20.9 inch
W: 71cm | 27.9 inch
H: 43 cm | 16.9 inch
Weight: 24 kg | 53 lb

Medium Stool

-

L: 68 cm | 26.8 inch
W: 68 cm | 26.8 inch
H: 40 cm | 15.8 inch
Weight: 14,5 kg | 32 lb

PACKAGING :

Type: Wood box
L: 53cm | 20.9 inch
W: 71cm | 27.9 inch
H: 43 cm | 16.9 inch
Weight: 25 kg | 55 lb

HOFF - PRE-COMPOSED FABRIC SELECTION

SELECTED FABRICS

1/ CHOOSE MODULES

2/ FABRICS : SHADES OF GREY

Grey-black

 Cat.3
STEELCUT TRI0 3 - 124

 Cat.2
FIELD 2 - 182

 Cat.3
SAVOY 60198

Grey-blue

 Cat.3
STEELCUT TRI0 3 - 205

 Cat.2
FIELD 2 - 222

 Cat.3
SAVOY 66165

Grey-beige

 Cat.3
STEELCUT TRI0 3 - 616

 Cat.2
FIELD 2 - 123

 Cat.3
SAVOY 61221



STEELCUT TRI0 3 - 124 / FIELD 2 - 182



STEELCUT TRI0 3 - 205 / FIELD 2 - 222



STEELCUT TRI0 3 - 616 / FIELD 2 - 123



FIELD 2 - 182 / SAVOY 60198



FIELD 2 - 222 / SAVOY 66165



FIELD 2 - 123 / SAVOY 61221



SAVOY 60198



SAVOY 66165



SAVOY 61221



STEELCUT TRI0 3 - 124



STEELCUT TRI0 3 - 205



STEELCUT TRI0 3 - 616

NUBILO

CONSTANCE GUISSET

2014 & 2015



Sofa and armchair

-

MATERIALS

Steel with matte grained powder coating

Seat and back foam: PU foam 45kg/m³

Cushions 100% PU foam 80G/m², cover fabric to be chosen by client

ORIGIN

Europe

TECHNICAL SPECIFICATIONS

Removable cushions



78

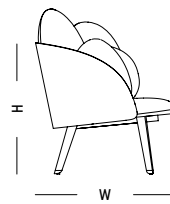
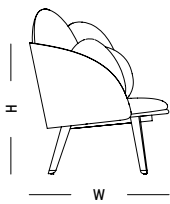
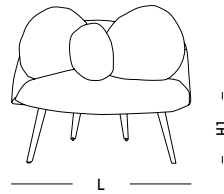
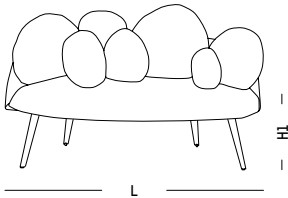

Sofa

-

L: 155 cm | 61 inch

W: 75 cm | 29.5 inch

H: 65 cm | 25.6 inch

H1: 40 cm | 15.7 inch

Weight: 50 kg | 110.2 lb

PACKAGING :

Type: Wood box

L: 170 cm | 66.9 inch

W: 80 cm | 31.5 inch

H: 70 cm | 27.6 inch

Weight: 80kg | 176 lb

Armchair

-

L: 77 cm | 30.3 inch

W: 70 cm | 27.6 inch

H: 65 cm | 25.6 inch

H1: 40 cm | 15.7 inch

Weight: 20 kg | 44.1 lb

PACKAGING :

Type: Wood box

L: 90 cm | 35.4 inch

W: 80 cm | 31.5 inch

H: 70 cm | 27.6 inch

Weight: 40 kg | 88 lb

NUBILO - PRE-COMPOSED FABRIC SELECTION

SELECTED FABRICS

1/ CHOOSE MODULES

2/ FABRICS : SHADES OF GREY

Grey-black

Base
Cat.3
STEELCUT TRIO 3 - 124

Set 1
Cat.2
FIELD 2 - 182

Set 2
Cat.3
SAVOY 60198

Grey-blue

Base
Cat.3
STEELCUT TRIO 3 - 205

Set 1
Cat.2
FIELD 2 - 222

Set 2
Cat.3
SAVOY 66165

Grey-beige

Base
Cat.3
STEELCUT TRIO 3 - 616

Set 1
Cat.2
FIELD 2 - 123

Set 2
Cat.3
SAVOY 61221



CUSTOMISE

**MAKE YOUR OWN CUSTOM
GRID, HOFF, NUBILO
SOFAS, ARMCHAIRS & STOOLS**

FOR LILY, PLEASE REFER TO FABRICS WITH *

**Find in the next pages, a selection of fabrics that are suitable for our range
of sofas and armchairs.**

For other fabrics (COM), please contact us for price and lead time.

FABRICS' SELECTIONS

TO CREATE YOUR CUSTOM GRID, HOFF AND NUBILO SOFAS, ARMCHAIRS, STOOLS - FOR LILY, PLEASE REFER TO FABRICS WITH *

CATEGORY 1

GABRIEL CHILI* | GABRIEL RHYTHM | GABRIEL RONDO

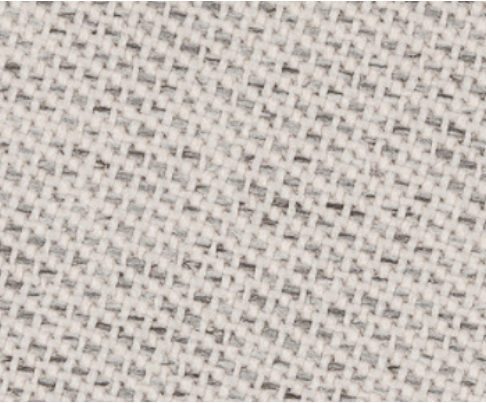

1A. GABRIEL CHILI*

MATERIAL: 100% post-consumer recycled polyester fr
Width : 140cm - 55in
Weight : 470g/ml - 16,60z/Lin.yd

DURABILITY: 60.000 Martindale
ENVIRONMENT: STANDARD 100 by OEKO-TEX®
FIRE STANDARDS: BS EN 1021 1&2 Cigarette and Match/ BS EN 1021-1 Cigarette
 BS 7176 Medium hazard/ BS 5852 Crib 5
 BS 5852 Crib 5 / Call 117

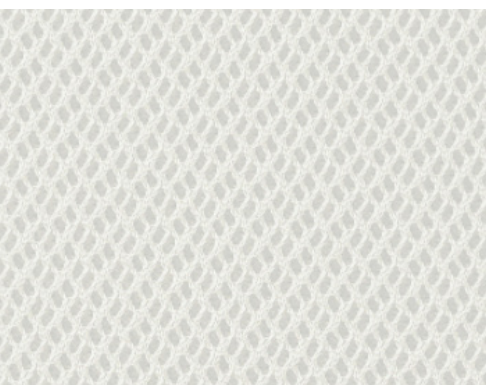

1B. GABRIEL RHYTHM

MATERIAL: 100% polyester/polyester flame retardant
Width : 140cm - 55in
Weight : 490g/ml - 17,240z/Lin.yd

DURABILITY: 70.000 Martindale
ENVIRONMENT: STANDARD 100 by OEKO-TEX®

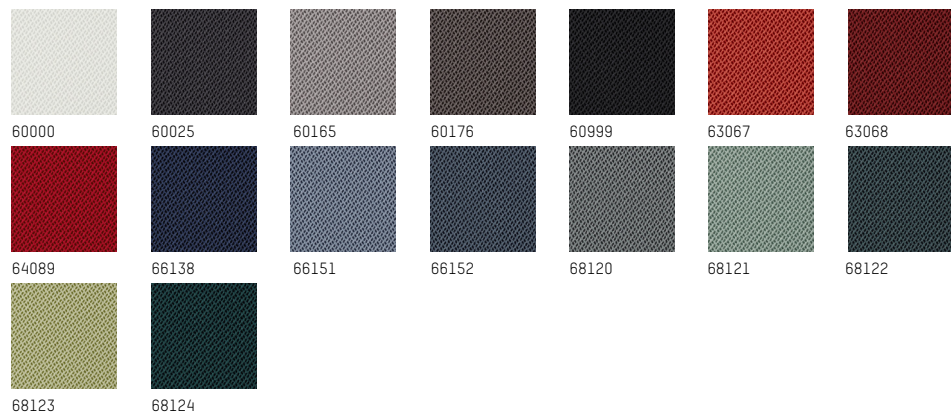

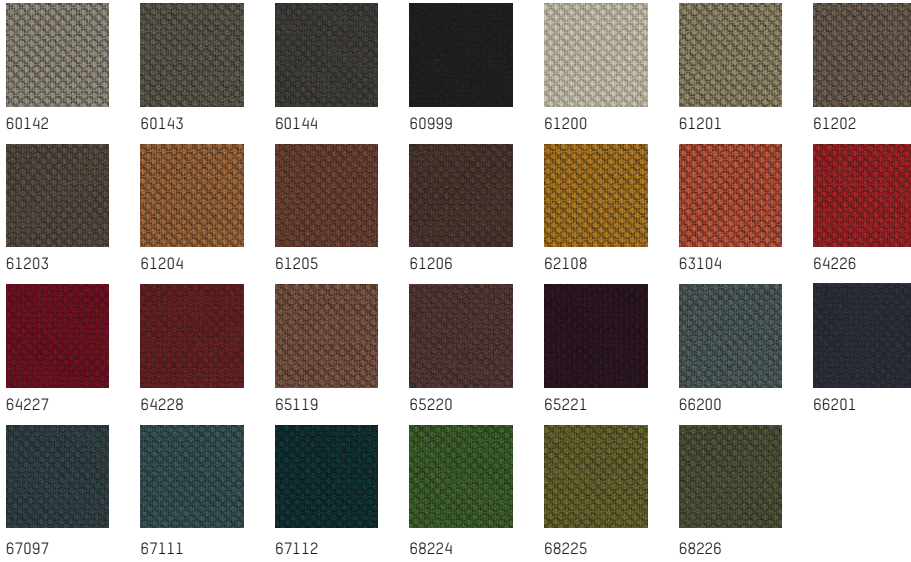

1C. GABRIEL RONDO

MATERIAL: 100% post-consumer recycled polyester fr
 Width : 140cm - 55in
 Weight : 470g/ml - 16,60z/Lin.yd

DURABILITY: 60.000 Martindale
ENVIRONMENT: STANDARD 100 by OEKO-TEX®
FIRE STANDARDS: BS EN 1021 1&2 Cigarette and Match/ BS EN 1021-1 Cigarette BS 7176 Medium hazard/ BS 5852 Crib 5 BS 5852 Crib 5 / Call 117

CATEGORY 2

**CAMIRA - VITA | GABRIEL FAME + FAME HYBRIDE | GABRIEL - CRISP | KVADRAT - FIELD 2
 GABRIEL FOCUS + FOCUS MELANGE**

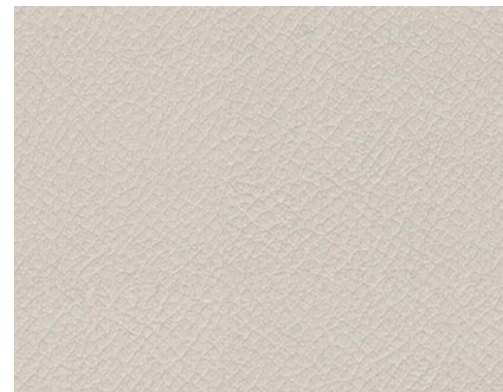

2A. CAMIRA - VITA

MATERIAL: Surface: 98% PVC, 2% PU
 Substrate: 100% Cotton
 Width : 140cm - 55in
 Weight : 850g/ml - 29,980z/Lin.yd

DURABILITY: 100.000 turns
ENVIRONMENT: Phthalate free
FIRE STANDARDS: EN 1021-1 (cigarette) EN 1021-2 (match) /BS 7176 Low Hazard BS 5852 Ignition Source 5 :BS 7176 Medium Hazard /BS 5852 Ignition Source 7 (with interliner)

FABRICS' SELECTIONS

TO CREATE YOUR CUSTOM GRID, HOFF AND NUBILO SOFAS, ARMCHAIRS, STOOLS - FOR LILY, PLEASE REFER TO FABRICS WITH *

CATEGORY 2

CAMIRA - VITA | GABRIEL FAME + FAME HYBRIDE* | GABRIEL - CRISP | KVADRAT - FIELD 2
GABRIEL FOCUS + FOCUS MELANGE

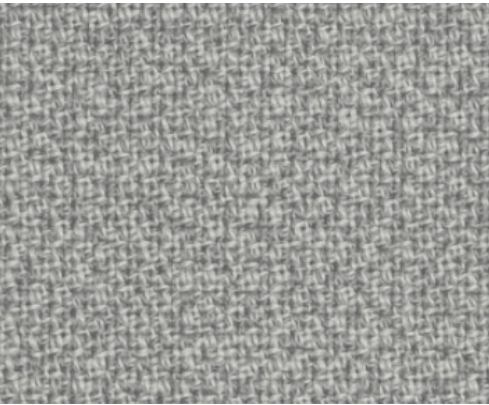

2B. GABRIEL FAME + FAME HYBRIDE*

MATERIAL: 95% New Zealand wool
/ 5% polyamide
Width : 140cm - 55in
Weight : 630g/ml - 22,220z/Lin.yd

DURABILITY: 150.000 Martindale
ENVIRONMENT: STANDARD 100 by OEKO-TEX®
FIRE STANDARDS: BS EN 1021 1&2 Cigarette
and Match/ BS EN 1021-1 Cigarette
BS 7176 Medium hazard/ BS 5852 Crib 5
BS 5852 Crib 5 / Call 117



FABRICS' SELECTIONS

TO CREATE YOUR CUSTOM GRID, HOFF AND NUBILO SOFAS, ARMCHAIRS, STOOLS - FOR LILY, PLEASE REFER TO FABRICS WITH *

CATEGORY 2

CAMIRA - VITA | GABRIEL FAME + FAME HYBRIDE | GABRIEL - CRISP | KVADRAT - FIELD 2
GABRIEL FOCUS + FOCUS MELANGE

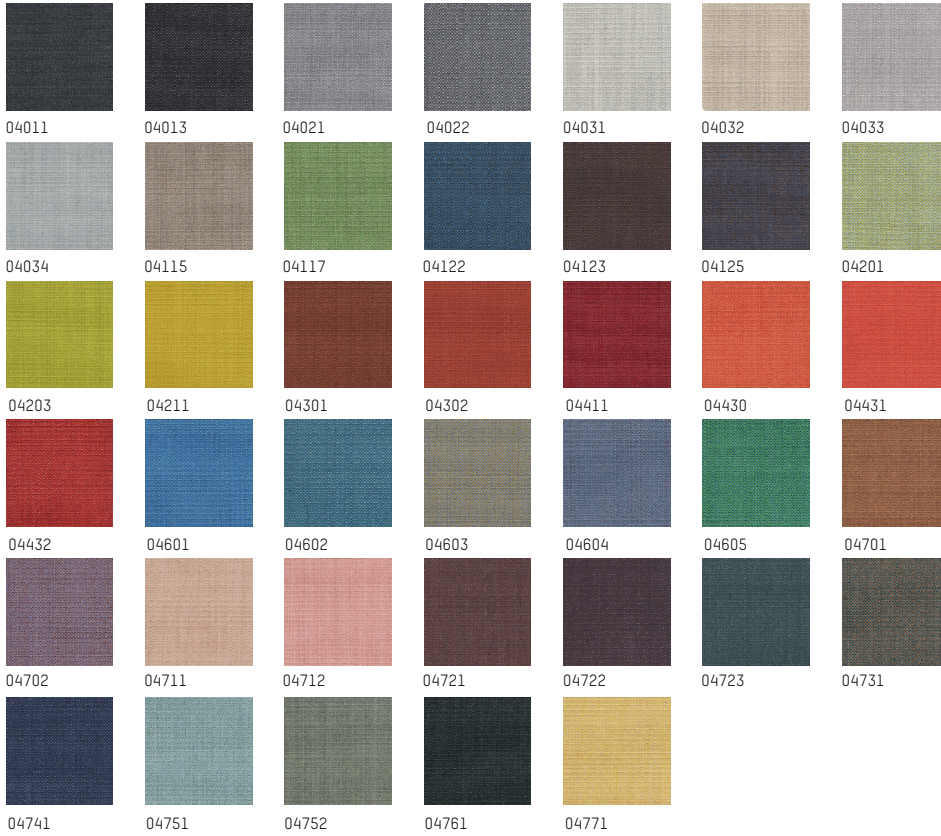

2C. GABRIEL - CRISP

MATERIAL: 93% New Zealand wool
/ 7% polyamide
Width: 140cm - 55in
Weight: 460g/ml - 16,230z/Lin.yd

DURABILITY: 200.000 Martindale
ENVIRONMENT: STANDARD 100 by OEKO-TEX®
/ EU Ecolabel

FIRE STANDARDS: BS EN 1021 1&2 Cigarette
and Match/ BS EN 1021-1 Cigarette
BS 7176 Medium hazard/ BS 5852 Crib 5
BS 5852 Crib 5 / Call 117

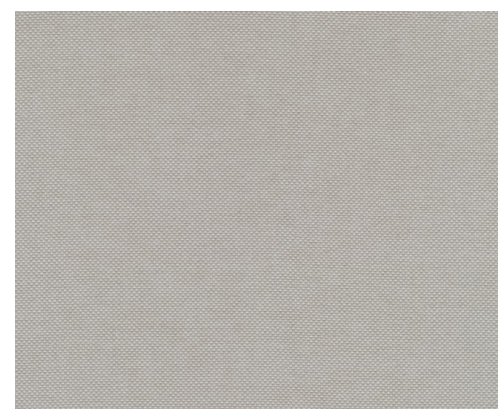
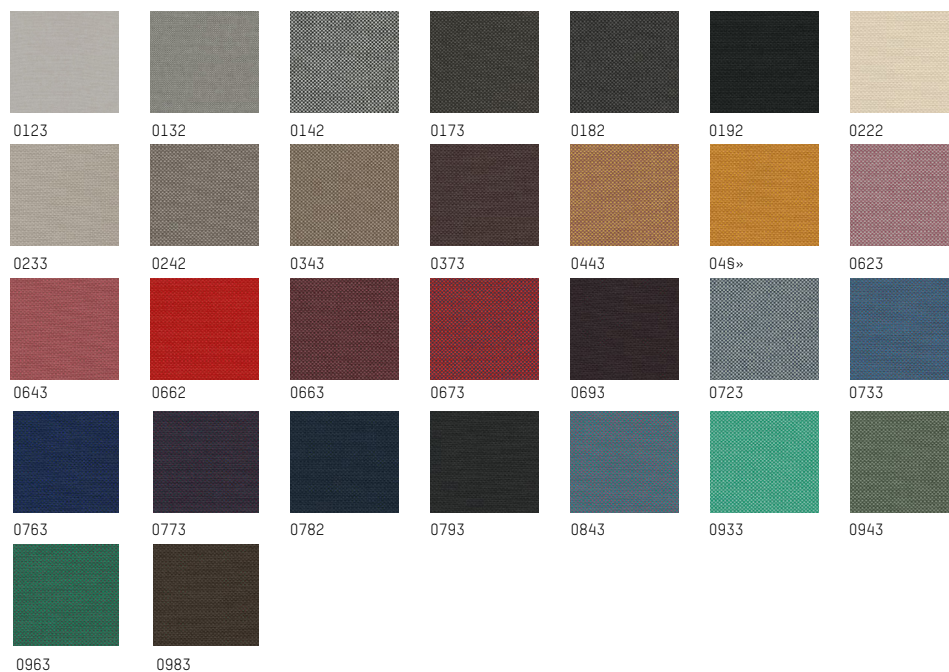

2D. KVADRAT - FIELD 2

MATERIAL: 100% Trevira CS
Width: 140cm - 55in
Weight: 450g/ml - 15,870z/Lin.yd

DURABILITY: 80.000 Martindale
ENVIRONMENT: EU Ecolabel, Greenguard
Gold, HPD, EPD

FIRE STANDARDS: BS 5852 Crib 5
EN 1021-1/2 / EN 13501-1 B-s1, d0

FABRICS' SELECTIONS

TO CREATE YOUR CUSTOM GRID, HOFF AND NUBILO SOFAS, ARMCHAIRS, STOOLS - FOR LILY, PLEASE REFER TO FABRICS WITH *

CATEGORY 2

CAMIRA - VITA | GABRIEL FAME + FAME HYBRIDE | GABRIEL - CRISP | KVADRAT - FIELD 2
GABRIEL FOCUS + FOCUS MÉLANGE

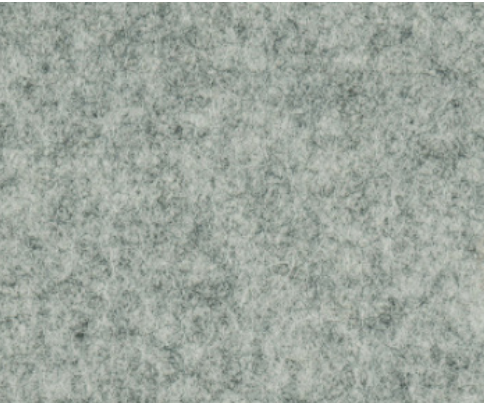

2E. GABRIEL FOCUS + FOCUS MÉLANGE

MATERIAL: 100% New Zealand wool
Width : 140cm - 55in
Weight : 660g/ml - 23,280z/Lin.yd

DURABILITY: 100.000 Martindale
ENVIRONMENT: STANDARD 100 by OEKO-TEX® / EU Ecolabel

FIRE STANDARDS: BS EN 1021 1&2 Cigarette and Match / BS 5852 Part 1 0,1 Cigarette & match



FABRICS' SELECTIONS

TO CREATE YOUR CUSTOM GRID, HOFF AND NUBILO SOFAS, ARMCHAIRS, STOOLS - FOR LILY, PLEASE REFER TO FABRICS WITH *

CATEGORY 3

CAMIRA - OCEANIC | GABRIEL - SAVOY | KVADRAT - CLAY - SAHCO | KVADRAT
- STEELCUT 2 | KVADRAT - STEELCUT TRIO 3 | KVADRAT - GALAXY | KVADRAT- ENCIRCLE

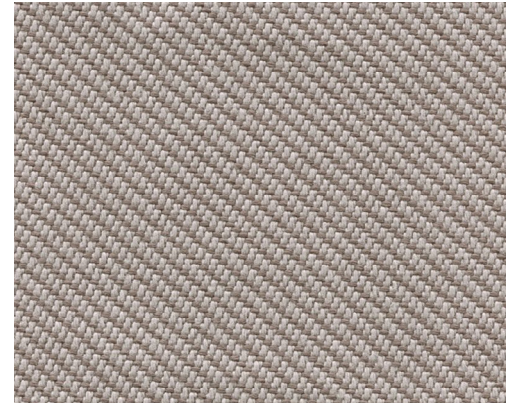
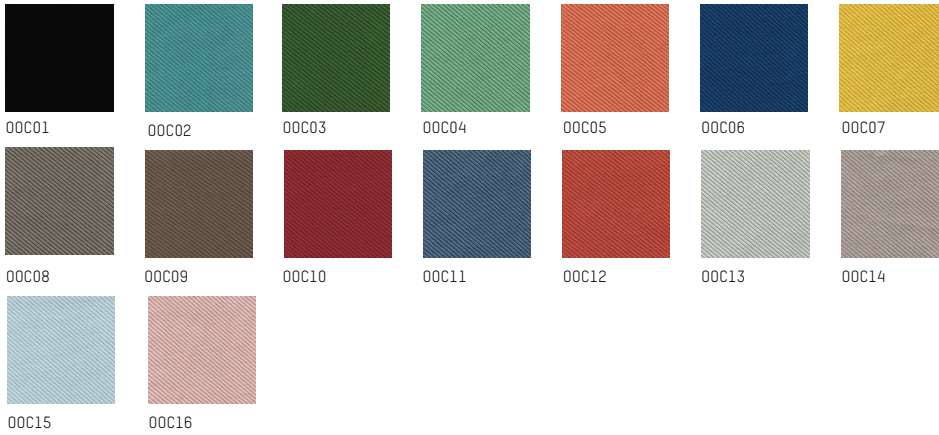

3A. CAMIRA - OCEANIC

MATERIAL: 100% post-consumer recycled polyester, including 50% SEAQUAL yarn.
Width : 140cm - 55in
Weight : 497g/ml - 17,530z/Lin.yd

DURABILITY: 135.000 Martindale

ENVIRONMENT: S EKO-TEX® Standard 100 / Certified to Indoor Advantage™ «Gold» / Made from 100% post-consumer recycled polyester / Non metallic dyestuffs.

FIRE STANDARDS: EN 1021 - 1 (cigarette) / EN 1021 - 2 (match) / BS 7176 Low Hazard / BS 5852 Ignition Source 5 with EnviroFlam5 / BS 7176 Medium Hazard with EnviroFlam5



3B. GABRIEL - SAVOY

MATERIAL: 100% Trevira CS
Width : 140cm - 55in
Weight : 600g/ml - 21,160z/Lin.yd

DURABILITY: 100.000 Martindale

ENVIRONMENT: STANDARD 100 by OEKO-TEX® / EU Ecolabel

FIRE STANDARDS: BS 5852 Crib 5
EN 1021-1/2 / EN 13501-1 B-s1, d0

FABRICS' SELECTIONS

TO CREATE YOUR CUSTOM GRID, HOFF AND NUBILO SOFAS, ARMCHAIRS, STOOLS - FOR LILY, PLEASE REFER TO FABRICS WITH *

CATEGORY 3

CAMIRA - OCEANIC | GABRIEL - SAVOY | KVADRAT - CLAY - SAHCO | KVADRAT - STEELCUT 2 | KVADRAT - STEELCUT TRIO 3 | KVADRAT - GALAXY | KVADRAT- ENCIRCLE*



3C. KVADRAT - CLAY - SAHCO

MATERIAL: 76% linen, 21% cotton, 3% polyester
Width: 140cm - 55in
Weight: 768g/ml - 27,09oz/Lin.yd

DURABILITY: 45.000 Martindale
ENVIRONMENT: GREENGUARD GOLD, HPD,
EPD FIRE STANDARDS: BS 5852 source 0 / 1, EN 1021-1 / 2 With flame retardant treatment: BS 5852 source 5.



3D. KVADRAT - STEELCUT 2

MATERIAL: 90% new wool worsted
 10% nylon
Width: 175cm - 69in
Weight: 825g/ml - 29,10oz/Lin.yd

DURABILITY: 100.000 Martindale
ENVIRONMENT: EU Ecolabel, Greenguard Gold, HPD, EPD
FIRE STANDARDS: BS 5852 part 1 EN 1021-1/2
 BS 5852 crib 5 with treatment *
 SN 198 898 5.3 with treatment *

FABRICS' SELECTIONS

TO CREATE YOUR CUSTOM GRID, HOFF AND NUBILO SOFAS, ARMCHAIRS, STOOLS - FOR LILY, PLEASE REFER TO FABRICS WITH *

CATEGORY 3

CAMIRA - OCEANIC | GABRIEL - SAVOY | KVADRAT - CLAY - SAHCO | KVADRAT
- STEELCUT 2 | KVADRAT - STEELCUT TRIO 3 | KVADRAT - GALAXY | KVADRAT- ENCIRCLE

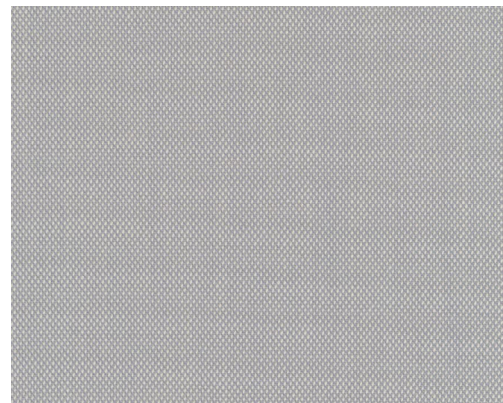
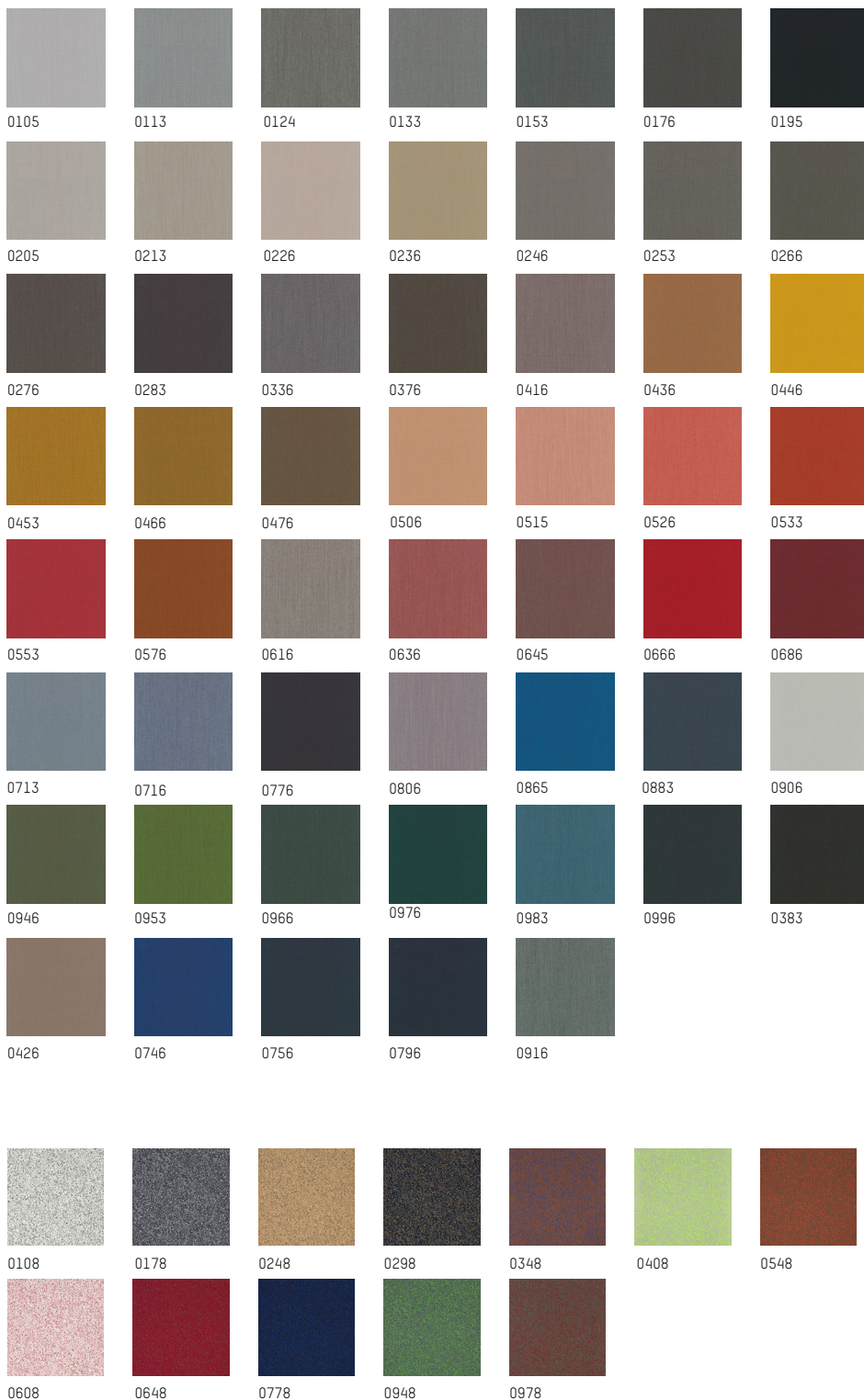

3E. KVADRAT - STEELCUT TRIO 3

MATERIAL: 90% new wool worsted 10% nylon
Width : 140cm - 55in
Weight : 770g/ml - 27,160z/Lin.yd

DURABILITY: 100.000 Martindale

ENVIRONMENT: EU Ecolabel, Greenguard Gold, HPD, EPD

FIRE STANDARDS: EN 1021-1/2
BS 5852 part 1/ BS Crib 5
With flame retardant treatment.

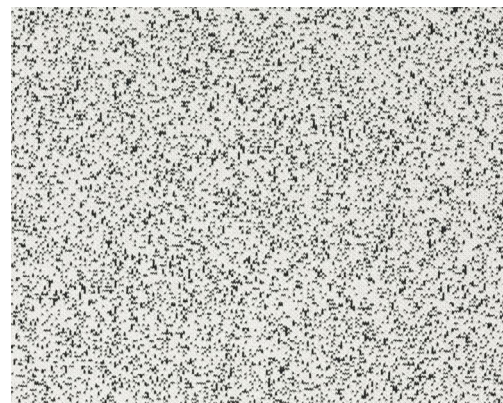

3F. KVADRAT - GALAXY

MATERIAL: 100% polyester FR
Width : 175cm - 69in
Weight : 760g/ml - 26,810z/Lin.yd

DURABILITY: 50.000 Martindale

ENVIRONMENT: Greenguard Gold, HPD, EPD
FIRE STANDARDS: BS 5852 Crib 5, EN 1021-1/2

FABRICS' SELECTIONS

TO CREATE YOUR CUSTOM GRID, HOFF AND NUBILO SOFAS, ARMCHAIRS, STOOLS - FOR LILY, PLEASE REFER TO FABRICS WITH *

CATEGORY 3

CAMIRA - OCEANIC | GABRIEL - SAVOY | KVADRAT - CLAY - SAHCO | KVADRAT
- STEELCUT 2 | KVADRAT - STEELCUT TRIO 3 | KVADRAT - GALAXY | KVADRAT- ENCIRCLE

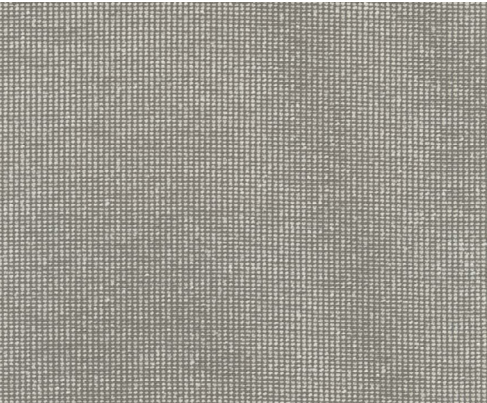

36. KVADRAT - ENCIRCLE*

MATERIAL: 76% linen, 21% cotton, 3% polyester
Width: 140cm - 55in
Weight: 768g/ml - 27,090z/Lin.yd

DURABILITY: 45.000 Martindale
ENVIRONMENT: GREENGUARD GOLD, HPD,
EPD FIRE STANDARDS: BS 5852 source 0 / 1, EN 1021-1 / 2 With flame retardant treatment: BS 5852 source 5.



FABRICS' SELECTIONS

TO CREATE YOUR CUSTOM GRID, HOFF AND NUBILO SOFAS, ARMCHAIRS, STOOLS - FOR LILY, PLEASE REFER TO FABRICS WITH *

CATEGORY 4

KVADRAT - MOSS | KVADRAT - FOSS | KVADRAT - COMFORT+ | KVADRAT - MOLLY 2



4A. KVADRAT - MOSS

MATERIAL: 100% post-consumer recycled polyester fr
Width : 140cm - 55in
Weight : 470g/ml - 16,60z/Lin.yd

DURABILITY: 60.000 Martindale
ENVIRONMENT: STANDARD 100 by OEKO-TEX®
FIRE STANDARDS: BS EN 1021 1&2 Cigarette and Match/ BS EN 1021-1 Cigarette BS 7176 Medium hazard/ BS 5852 Crib 5 BS 5852 Crib 5 / Call 117



4B. KVADRAT - FOSS

MATERIAL: 76% new wool worsted
11% viscose 8% nylon 5% linen
Width : 145cm - 57in
Weight : 500g/ml - 17,640z/Lin.yd

DURABILITY: 100.000 Martindale
ENVIRONMENT: EU Ecolabel, Greenguard Gold, HPD, EPD
FIRE STANDARDS: BS 5852 part 1 EN 1021-1/2
BS 5852 crib 5 with treatment *

FABRICS' SELECTIONS

TO CREATE YOUR CUSTOM GRID, HOFF AND NUBILO SOFAS, ARMCHAIRS, STOOLS - FOR LILY, PLEASE REFER TO FABRICS WITH *

CATEGORY 4

KVADRAT - MOSS | KVADRAT - FOSS | KVADRAT - COMFORT+ | KVADRAT - MOLLY 2



4C. KVADRAT - COMFORT +

MATERIAL: 78% polyester/12% polyurethane incl. antistatic fibers and fire retardant fibers in the backside
Width: 140cm - 55in
Weight: 385g/ml - 13,580z/Lin.yd

DURABILITY: 150.000 Martindale
ENVIRONMENT: STANDARD 100 by OEKO-TEX®
FIRE STANDARDS: BS EN 1021 1&2 Cigarette and Match /BS EN 1021-1 Cigarette

00004	00005	00010	00018	00026	00028	00029
00033	00034	00035	00040	00049	00050	00280
01012	01043	01049	01065	01124	01147	01153
01160	01161	01163	01167	01414	01566	08384
08397	08402	08422	09055	09074	09075	09084
60002	60003	60004	60005	60008	60009	61002
61003	61013	61014	61015	61016	61018	62003
62004	62005	63001	63006	64001	64002	64003
64009	64012	64013	64014	65003	65012	66002
66004	66005	66008	66010	67001	67002	68000
68001	68003	68007	68008	68009	68010	68011

FABRICS' SELECTIONS

TO CREATE YOUR CUSTOM GRID, HOFF AND NUBILO SOFAS, ARMCHAIRS, STOOLS - FOR LILY, PLEASE REFER TO FABRICS WITH *

CATEGORY 4

KVADRAT - MOSS | KVADRAT - FOSS | KVADRAT - COMFORT+ | KVADRAT - MOLLY 2



4D. KVADRAT - MOLLY 2

MATERIAL: 100% new wool worsted
Width : 140cm - 55in
Weight : 610g/ml - 21,520z/Lin.yd

DURABILITY: 75.000 Martindale
ENVIRONMENT: EU Ecolabel, Greenguard Gold, HPD, Only natural color wool
FIRE STANDARDS: BS 5852 part 1 EN 1021-½
 BS 5852 crib 5 with treatment *



CATEGORY 5

VIDAR 4 - KVADRAT* | SOVOS - LEATHER | KVADRAT - SAPHIRE



5A. VIDAR 4 - KVADRAT*

MATERIAL: 94% new wool 6% nylon
Width : 140cm - 55in
Weight : 765g/ml - 26,98 Oz/Lin.yd

DURABILITY: : 100.000 Martindale
ENVIRONMENT: EU Ecolabel, Greenguard Gold, HPD, EPD
FIRE STANDARDS: BS 5852 part 1 EN 1021-½
 BS 5852 crib 5 with treatment *

FABRICS' SELECTIONS

TO CREATE YOUR CUSTOM GRID, HOFF AND NUBILO SOFAS, ARMCHAIRS, STOOLS - FOR LILY, PLEASE REFER TO FABRICS WITH *

CATEGORY 5

VIDAR 4 - KVADRAT I SOVOS - LEATHER I KVADRAT - SAPHIRE



5B. SOVOS - LEATHER

MATERIAL: 76% linen, 21% cotton, 3% polyester
Width : 140cm - 55in
Weight : 768g/ml - 27,090z/Lin.yd

DURABILITY: 45.000 Martindale
ENVIRONMENT: GREENGUARD GOLD, HPD,
EPD FIRE STANDARDS: BS 5852 source 0 / 1, EN 1021-1 / 2 With flame retardant treatment: BS 5852 source 5.

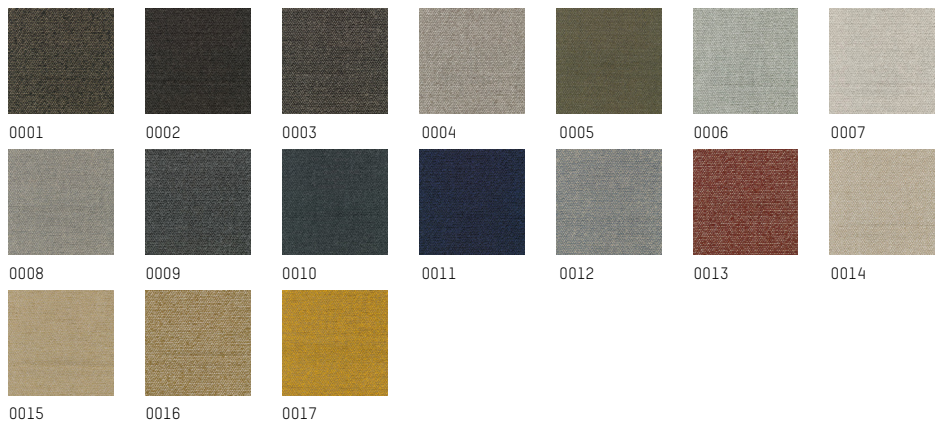
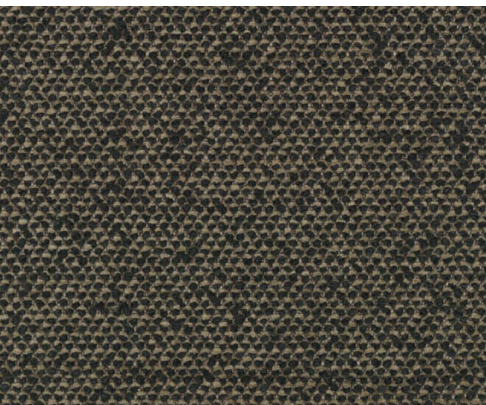

5C. KVADRAT - SAPHIRE

MATERIAL: 43% viscose 17% polyacrylic
 15% new wool 9% cotton 8% polyester
 8% linen
Width : 140cm - 55in
Weight : 1010g/ml - 35,630z/Lin.yd

DURABILITY: 44.000 Martindale
ENVIRONMENT: Greenguard Gold, HPD EPD
FIRE STANDARDS: : BS 5852 source 0 / 1 EN 1021-1 / 2 With flame retardant treatment: BS 5852 source 5

OUTDOOR



WEEK - END

STUDIO BRICHET ZIEGLER

2019

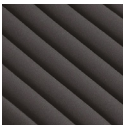

Anthracite



Pearl grey

Cushions

-

MATERIALS

Cover in polyester, Garnish foam in polyurethane

COLORS

Anthracite, Pearl grey

ORIGIN

France

TECHNICAL SPECIFICATIONS

Dryfeel foam
Suitable for outdoor use.

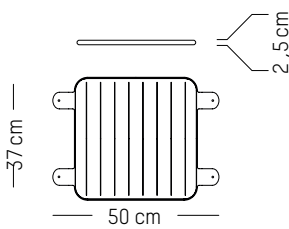

Small

-

L: 50 cm | 20 inch
W: 37 cm | 15 inch
H: 2,5 cm | 1 inch
Weight: 0,4 kg | 0.8 lb

PACKAGING :

L: 53cm | 20.9 inch
W: 53cm | 20.9 inch
Weight: 0,6 kg | 1.3 lb

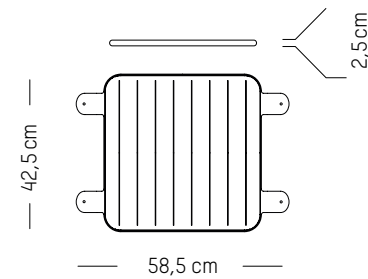

Large

-

L: 58,4 cm | 24 inch
W : 45 cm | 18 inch
H: 2,5 cm | 1 inch
Weight: 0,4 kg | 0.8 lb

PACKAGING :

L: 53cm | 20.9 inch
W: 53cm | 20.9 inch
Weight: 0,6 kg | 1.3 lb

WEEK-END

STUDIO BRICHET ZIEGLER

2017



Black



White



Blue



Burgundy



Blush



Terracotta



Jade green



Glass green



Yellow

Chair, Bridge & Armchair

-

MATERIALS

Aluminium, matte grained Anti UV powder coating for outdoor use

COLORS

Black, White, Blue, Burgundy, Blush, Terracotta, Jade green, Glass green, Yellow

ORIGIN

China

TECHNICAL SPECIFICATIONS

Compliant with EN 581-1 ; EN581 -2 for Contract Use

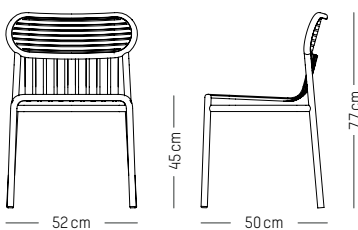

Chair

-

L: 52 cm | 20.5 inch
W: 50 cm | 19.7 inch
H: 77 cm | 30.3 inch
H1: 45 cm | 17.7 inch
Weight: 3 kg | 6.6 lb

PACKAGING (X2):

L: 60 cm | 23.6 inch
W: 53 cm | 20.9 inch
H: 98 cm | 38.6 inch
Weight: 8 kg | 17.7 lb

Stackable

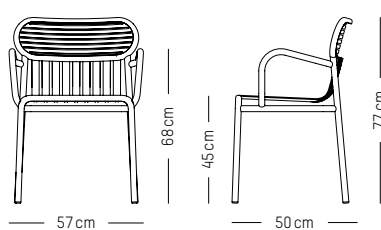

Bridge

-

L: 57 cm | 22.4 inch
W: 50 cm | 19.7 inch
H: 77 cm | 30.3 inch
H1: 45 cm | 17.7 inch
Weight: 4 kg | 8.8 lb

PACKAGING (X2) :

L: 60 cm | 23.6 inch
W: 53 cm | 20.9 inch
H: 98 cm | 38.6 inch
Weight: 11,5 kg | 25.4 lb

Stackable

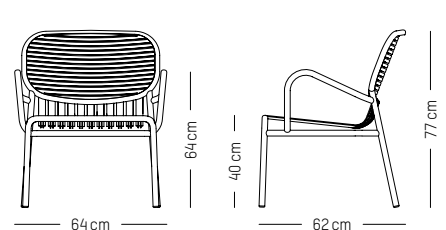

Armchair

-

L: 66 cm | 26 inch
L: 62 cm | 24.4 inch
H: 77 cm | 30.3 inch (back)
H: 40 cm | 15.7 inch (seat)
H: 62 cm | 24.4 inch (armrests)
Weight: 5kg | 11 lb

PACKAGING (X2) :

L: 70 cm | 27.6 inch
W: 70 cm | 27.6 inch
H: 83 cm | 32.7 inch
Weight : 15 kg | 33 lb

Stackable

WEEK-END

STUDIO BRICHET ZIEGLER

2019



Black



White



Blue

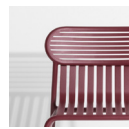

Burgundy



Blush



Terracotta



Jade green



Glass green



Yellow

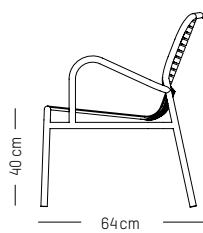
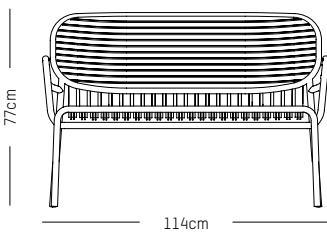

2 seater sofa

-

L: 113,5 cm | 44.5 inch

W: 64 cm | 24.2 inch

H: 78.5 cm | 31 inch (back)

H: 40 cm | 15.7 inch (seat)

Weight: 9 kg | 19.8 lb

PACKAGING :

L: 70 cm | 27.6 inch

W: 120 cm | 47.2 inch

H: 83 cm | 32.7 inch

Weight: 12 kg | 26.5 lb

Stackable

Sofa

-

MATERIALS

Aluminium, matte grained Anti UV powder coating for outdoor use

COLORS

Black, White, Blue, Burgundy, Blush, Terracotta, Jade green, Glass green, Yellow

ORIGIN

China

TECHNICAL SPECIFICATIONS

Compliant with EN 581-1 ; EN581 -2 for Contract Use

WEEK - END

STUDIO BRICHET ZIEGLER

2017 & 2019



Black



White



Blue



Burgundy



Blush



Terracotta



Jade green



Glass green



Yellow

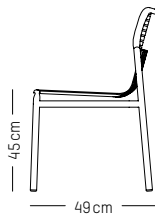
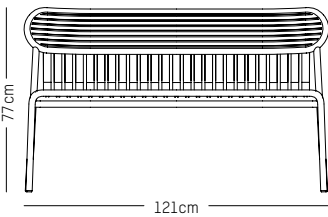

Benches

-

MATERIALS

Aluminium, matte grained Anti UV powder coating for outdoor use

COLORS

Black, White, Blue, Burgundy, Blush, Terracotta, Jade green, Glass green, Yellow

ORIGIN

China

TECHNICAL SPECIFICATIONS

Compliant with EN 581-1 ; EN581 -2 for Contract Use

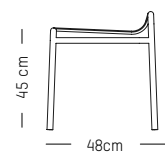
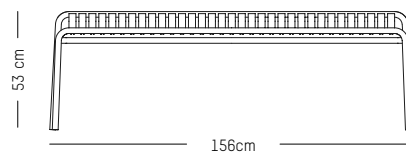

Bench

-

L: 121 cm | 47.7 inch
W: 49 cm | 19.3 inch
H: 77 cm | 30.3 inch (back)
H: 40 cm | 15.7 inch (seat)
Weight: 11 kg | 24.2 lb

PACKAGING :

L: 130 cm | 51.2 inch
W: 55 cm | 21.6 inch
H: 83 cm | 32.7 inch
Weight: 14 kg | 30.9 lb

Stackable

Bench without back

-

L: 156 cm | 61.4 inch
W: 50 cm | 19.7 inch
H: 45 cm | 15.8 inch (seat)
Weight: 8 kg | 17.6 lb

PACKAGING :

L: 160 cm | 63 inch
W: 55 cm | 21.6 inch
H: 83 cm | 32.7 inch
Weight: 11 kg | 24.3 lb

Stackable

WEEK - END

STUDIO BRICHET ZIEGLER

2017 & 2019



Black



White



Blue



Burgundy



Blush



Terracotta



Jade green



Glass green



Yellow

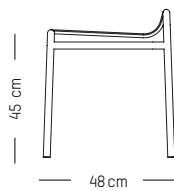
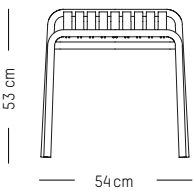

Stool

-

L: 53,3 cm | 21 inch
W: 58 cm | 22.8 inch
H: 53 cm | 20.9 inch
H (seat): 45 cm | 18 inch
Weight: 3 kg | 6.6 lb

PACKAGING :

L: 57 cm | 22.4 inch
W: 61 cm | 24 inch
H: 56 cm | 22 inch
Weight: 5 kg | 11 lb

Stackable

Stools

-

MATERIALS

Aluminium, matte grained Anti UV powder coating for outdoor use

COLORS

Black, White, Blue, Burgundy, Blush, Terracotta, Jade green, Glass green, Yellow

ORIGIN

China

TECHNICAL SPECIFICATIONS

Compliant with EN 581-1 ; EN581 -2 for Contract Use

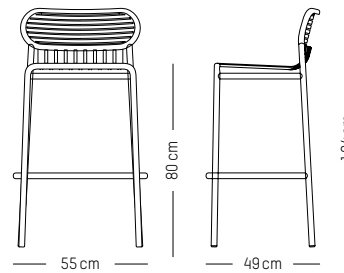

Bar stool

-

L: 49 cm | 19.3 inch
W: 55 cm | 19.3 inch
H: 104cm | 50.9 inch
H (seat): 80 cm | 32 inch
Weight: 5,6 kg | 12.3 lb

PACKAGING :

L: 53 cm | 20.9 inch
W: 58 cm | 22.8 inch
H: 110 cm | 43.3 inch
Weight: 8 kg | 17.7 lb

WEEK - END

STUDIO BRICHET ZIEGLER

2019

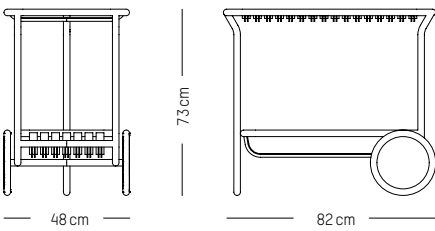

Trolley

-

MATERIALS

Aluminium, matte grained Anti UV powder coating for outdoor use

COLORS

Black, White, Blue, Burgundy, Blush, Terracotta, Jade green, Glass green, Yellow

ORIGIN

China

Trolley

-

W: 48 cm | 19 inch
L: 82 cm | 32.3 inch
H: 73 cm | 29 inch
Weight: 9 kg | 20 lb

PACKAGING :

L: 85 cm | 33.5 inch
W: 51 cm | 20.1 inch
H: 76 cm | 29.3 inch
Weight : 12 kg | 26.5 lb

WEEK - END

STUDIO BRICHET ZIEGLER

2017 & 2019

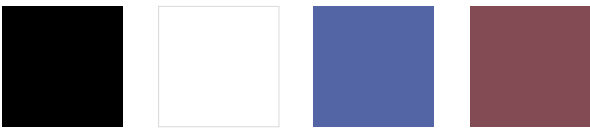

Black

White

Blue

Burgundy



Blush



Terracotta



Jade green



Glass green



Yellow

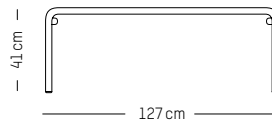
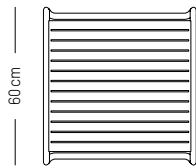
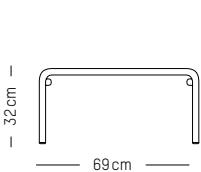

Coffee table

-

W: 60 cm | 23.6 inch

L: 69 cm | 27.2 inch

H: 32 cm | 12.6 inch

Weight: 4 kg | 8.8 lb

PACKAGING :

L: 72 cm | 28.3 inch

W: 72 cm | 28.3 inch

H: 35 cm | 13.8 inch

Weight : 5 kg | 11 lb

Long coffee table

-

W: 127 cm | 50 inch

L: 51 cm | 20 inch

H: 41 cm | 16.1 inch

Weight: 5 kg | 11 lb

PACKAGING :

L: 130 cm | 51.2 inch

W: 58 cm | 22.8 inch

H: 45 cm | 17.7 inch

Weight: 6 kg | 13.6 lb

WEEK - END

STUDIO BRICHET ZIEGLER

2017



Dining tables

-

MATERIALS

Aluminium, matte grained Anti UV powder coating for outdoor use

COLORS

Black, White, Blue, Burgundy, Blush, Terracotta, Jade green, Glass green, Yellow

ORIGIN

China



Black

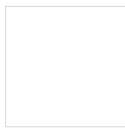

White



Blue



Burgundy



Blush



Terracotta



Jade green



Glass green

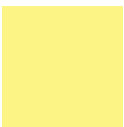

Yellow

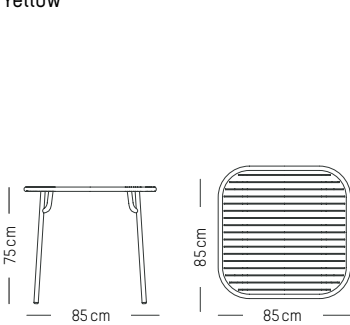

Square table

-

L: 85 cm | 33.5 inch
W: 85 cm | 33.5 inch
H: 75 cm | 29.5 inch
Weight: 12 kg | 26.5 lb

PACKAGING :

packaging tabletop
L: 86 cm | 33.9 inch
W: 86 cm | 33.9 inch
H: 5 cm | 2 inch
Weight: 10 kg | 22 lb

packaging legs (x2)
L: 19 cm | 7.5 inch
W: 19 cm | 7.5 inch
H: 80 cm | 31.5 inch
Weight: 4 kg | 8.9 lb

Assembly

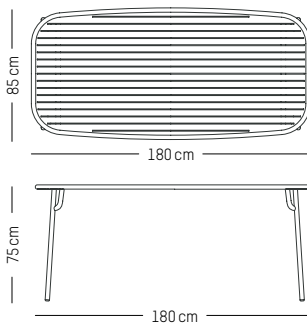

Rectangular table medium

-

W: 85 cm | 33.5 inch
L: 180 cm | 70.9 inch
H: 75 cm | 29.5 inch
Weight: 22,3 kg | 49.2 lb

PACKAGING :

packaging table top
L: 182 cm | 71.7 inch
W: 88 cm | 34.6 inch
H: 5 cm | 2 inch
Weight: 22 kg | 48.5 lb

packaging legs (x2)
L: 19 cm | 7.5 inch
W: 19 cm | 7.5 inch
H: 80 cm | 31.5 inch
Weight: 4 kg | 8.9 lb

Assembly

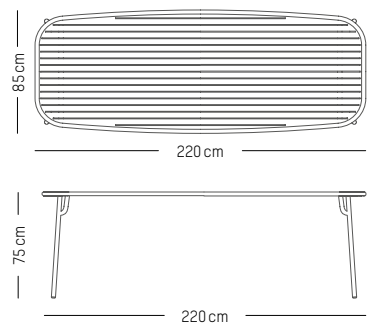

Rectangular table large

-

W: 85 cm | 33.5 inch
L: 220 cm | 86.6 inch
H: 75 cm | 29.5 inch
Weight: 27 kg | 59.5 lb

PACKAGING :

packaging table top
L: 222 cm | 87.4 inch
W: 88 cm | 34.6 inch
H: 5 cm | 2 inch
Weight: 27 kg | 59.5 lb

packaging legs (x2)
L: 19 cm | 7.5 inch
W: 19 cm | 7.5 inch
H: 80 cm | 31.5 inch
Weight: 4 kg | 8.9 lb

Assembly

WEEK - END

STUDIO BRICHET ZIEGLER

2019



Black

White

Blue

Burgundy

Blush

Terracotta

Jade green

Glass green

Yellow

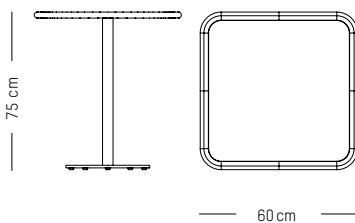

Bistro tables

-

MATERIALS

Aluminium, matte grained Anti UV powder coating for outdoor use

COLORS

Black, White, Blue, Burgundy, Blush, Terracotta, Jade green, Glass green, Yellow

ORIGIN

China

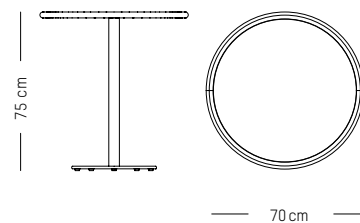

Square bistro table

-

L: 60 cm | 27.5 inch

W: 60cm | 27.5 inch

H: 75 cm | 29.5 inch

Weight: 11 kg | 24.2 lb

PACKAGING :

L: 72 cm | 28.3 inch

W: 72 cm | 28.3 inch

H: 78 cm | 30.7 inch

Weight: 14 kg | 30.9 lb

Assembly

Round bistro table

-

Ø: 70 cm | 23.6 inch

L: 70 cm | 23.6 inch

H: 75 cm | 29.5 inch

Weight: 10 kg | 22 lb

PACKAGING :

L: 73 cm | 29 inch

W: 73 cm | 29 inch

H: 78 cm | 30.7 inch

Weight: 12 kg | 26.5 lb

Assembly

WEEK - END

STUDIO BRICHET ZIEGLER

2019

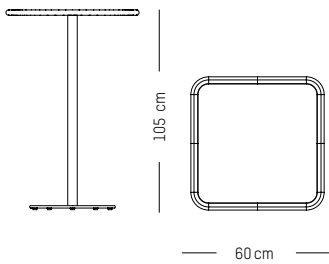

High table square

L: 60 cm | 27.5 inch
W: 60cm | 27.5 inch
H: 105 cm | 41.3 inch
Weight: 13 kg | 29 lb

PACKAGING :

L: 72 cm | 28.3 inch
W: 72 cm | 28.3 inch
H: 108 cm | 42.5 inch
Weight: 15 kg | 33 lb

Assembly

High tables

MATERIALS

Aluminium, matte grained Anti UV powder coating for outdoor use

COLORS

Black, White, Blue, Burgundy, Blush, Terracotta, Jade green, Glass green, Yellow

ORIGIN

China

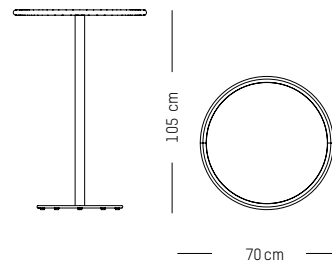

High table round

Ø: 70 cm | 23.6 inch
L: 70 cm | 23.6 inch
H: 105 cm | 41.3 inch
Weight: 12 kg | 26.4 lb

PACKAGING :

L: 73 cm | 29 inch
W: 73 cm | 29 inch
H: 108 cm | 42.5 inch
Weight: 14 kg | 30.9 lb

Assembly

WEEK - END

STUDIO BRICHET ZIEGLER

2017

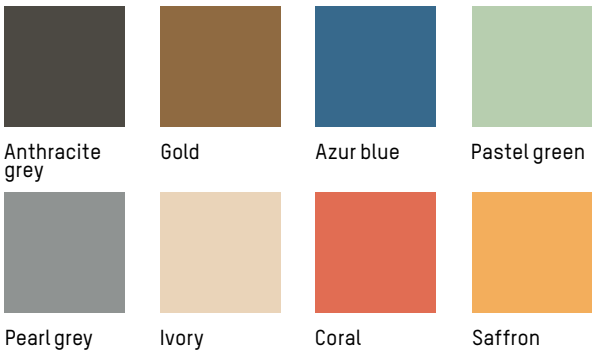

FOR CONTRACT PROJECT WITH MINIMUM QUANTITY

Chair, Bridge & Armchair

MATERIALS

Aluminium, matte grained Anti UV powder coating for outdoor use

COLOURS

Anthracite grey, Gold, Azur blue, Pastel green, Pearl grey, Ivory, Coral, Saffron

ORIGIN

China

TECHNICAL SPECIFICATIONS

Compliant with EN 581-1 ; EN581 -2 for Contract Use

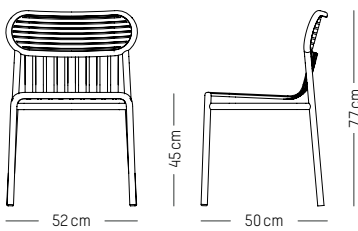

Chair

L: 52 cm | 20.5 inch
W: 50 cm | 19.7 inch
H: 77 cm | 30.3 inch
H1: 45 cm | 17.7 inch
Weight: 3 kg | 6.6 lb

PACKAGING (X2):

L: 60 cm | 23.6 inch
W: 53 cm | 20.9 inch
H: 98 cm | 38.6 inch
Weight: 8 kg | 17.7 lb

Stackable

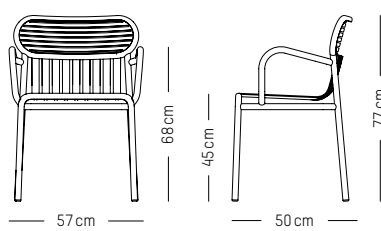

Bridge

L: 57 cm | 22.4 inch
W: 50 cm | 19.7 inch
H: 77 cm | 30.3 inch
H1: 45 cm | 17.7 inch
Weight: 4 kg | 8.8 lb

PACKAGING (X2) :

L: 60 cm | 23.6 inch
W: 53 cm | 20.9 inch
H: 98 cm | 38.6 inch
Weight: 11,5 kg | 25.4 lb

Stackable

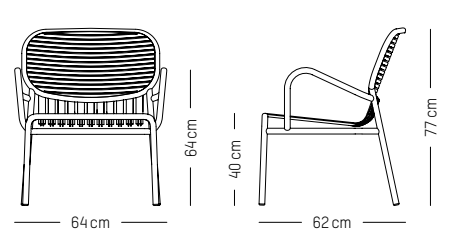

Armchair

L: 66 cm | 26 inch
L: 62 cm | 24.4 inch
H: 77 cm | 30.3 inch (back)
H: 40 cm | 15.7 inch (seat)
H: 62 cm | 24.4 inch (armrests)
Weight: 5kg | 11 lb

PACKAGING (X2) :

L: 70 cm | 27.6 inch
W: 70 cm | 27.6 inch
H: 83 cm | 32.7 inch
Weight : 15 kg | 33 lb

Stackable



WEEK - END

STUDIO BRICHET ZIEGLER

2019



Anthracite grey



Gold



Azur blue



Pastel green



Pearl grey



Ivory



Coral



Saffron

FOR CONTRACT PROJECT WITH MINIMUM QUANTITY

Sofa

-

MATERIALS

Aluminium, matte grained Anti UV powder coating for outdoor use

COLOURS

Anthracite grey, Gold, Azur blue, Pastel green, Pearl grey, Ivory, Coral, Saffron

ORIGIN

China

TECHNICAL SPECIFICATIONS

Compliant with EN 581-1 ; EN581 -2 for Contract Use

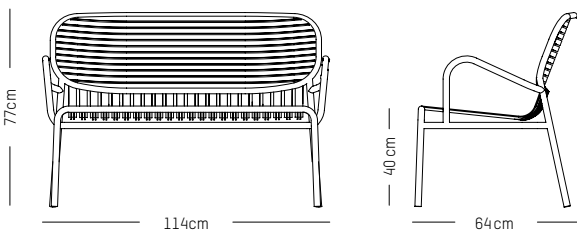

2 seater sofa

-

L: 113,5 cm | 44.5 inch

W: 64 cm | 24.2 inch

H: 78.5 cm | 31 inch (back)

H: 40 cm | 15.7 inch (seat)

Weight: 9 kg | 19.8 lb

PACKAGING :

L: 70 cm | 27.6 inch

W: 120 cm | 47.2 inch

H: 83 cm | 32.7 inch

Weight: 12 kg | 26.5 lb

Stackable

WEEK - END

STUDIO BRICHET ZIEGLER

2017 & 2019

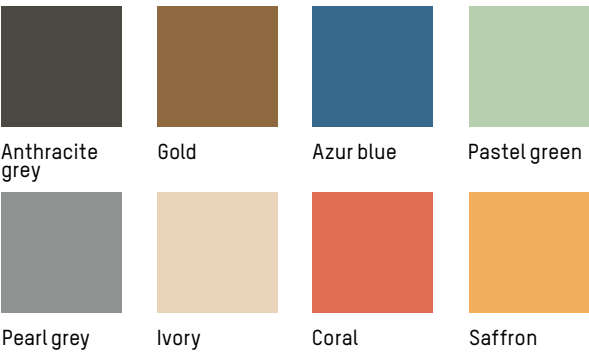

FOR CONTRACT PROJECT WITH MINIMUM QUANTITY

Benches

MATERIALS

Aluminium, matte grained Anti UV powder coating for outdoor use

COLOURS

Anthracite grey, Gold, Azur blue, Pastel green, Pearl grey, Ivory, Coral, Saffron

ORIGIN

China

TECHNICAL SPECIFICATIONS

Compliant with EN 581-1 ; EN581 -2 for Contract Use

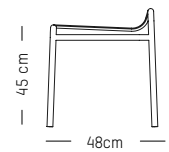
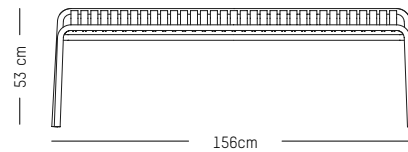
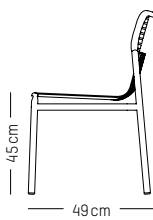
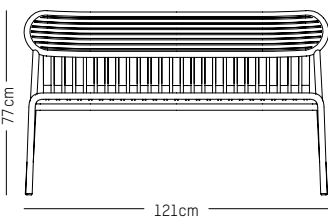

Bench

L: 121 cm | 47.7 inch
W: 49 cm | 19.3 inch
H: 77 cm | 30.3 inch (back)
H: 40 cm | 15.7 inch (seat)
Weight: 11 kg | 24.2 lb

PACKAGING :

L: 130 cm | 51.2 inch
W: 55 cm | 21.6 inch
H: 83 cm | 32.7 inch
Weight: 14 kg | 30.9 lb

Stackable

Bench without back

L: 156 cm | 61.4inch
W: 50 cm | 19.7 inch
H: 45 cm | 15.8 inch (seat)
Weight: 8 kg | 17.6 lb

PACKAGING :

L: 160 cm | 63 inch
W: 55 cm | 21.6 inch
H: 83 cm | 32.7 inch
Weight: 11 kg | 24.3 lb

Stackable

WEEK - END

STUDIO BRICHET ZIEGLER

2017 & 2019



Anthracite grey



Gold



Azur blue



Pastel green



Pearl grey



Ivory



Coral



Saffron

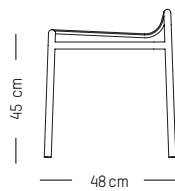
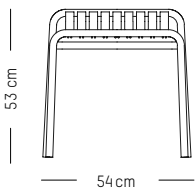

Stool

-

L: 53,3 cm | 21 inch
W: 58 cm | 22.8 inch
H: 53 cm | 20.9 inch
H (seat): 45 cm | 18 inch
Weight: 3 kg | 6.6 lb

PACKAGING :

L: 57 cm | 22.4 inch
W: 61 cm | 24 inch
H: 56 cm | 22 inch
Weight: 5 kg | 11 lb

Stackable

FOR CONTRACT PROJECT WITH MINIMUM QUANTITY

Stools

-

MATERIALS

Aluminium, matte grained Anti UV powder coating for outdoor use

COLOURS

Anthracite grey, Gold, Azur blue, Pastel green, Pearl grey, Ivory, Coral, Saffron

ORIGIN

China

TECHNICAL SPECIFICATIONS

Compliant with EN 581-1 ; EN581 -2 for Contract Use

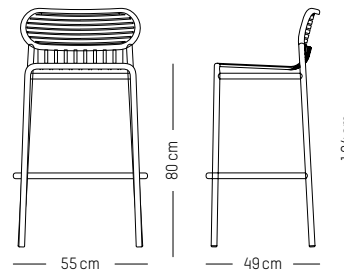

Bar stool

-

L: 49 cm | 19.3 inch
W: 55 cm | 19.3 inch
H: 104cm | 50.9 inch
H (seat): 80 cm | 32 inch
Weight: 5,6 kg | 12.3 lb

PACKAGING :

L: 53 cm | 20.9 inch
W: 58 cm | 22.8 inch
H: 110 cm | 43.3 inch
Weight: 8 kg | 17.7 lb

WEEK - END

STUDIO BRICHET ZIEGLER

2019

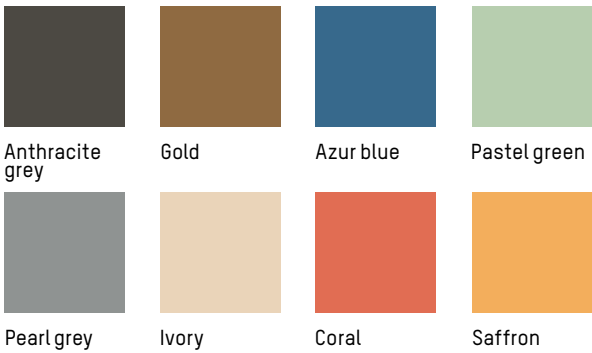

FOR CONTRACT PROJECT WITH MINIMUM QUANTITY

Trolley

-

MATERIALS

Aluminium, matte grained Anti UV powder coating for outdoor use

COLOURS

Anthracite grey, Gold, Azur blue, Pastel green, Pearl grey, Ivory, Coral, Saffron

ORIGIN

China

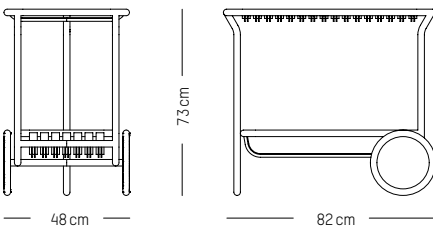

Trolley

-

W: 48 cm | 19 inch
L: 82 cm | 32.3 inch
H: 73 cm | 29 inch
Weight: 9 kg | 20 lb

PACKAGING :

L: 85 cm | 33.5 inch
W: 51 cm | 20.1 inch
H: 76 cm | 29.3 inch
Weight : 12 kg | 26.5 lb

WEEK-END

STUDIO BRICHET ZIEGLER

2017 & 2019

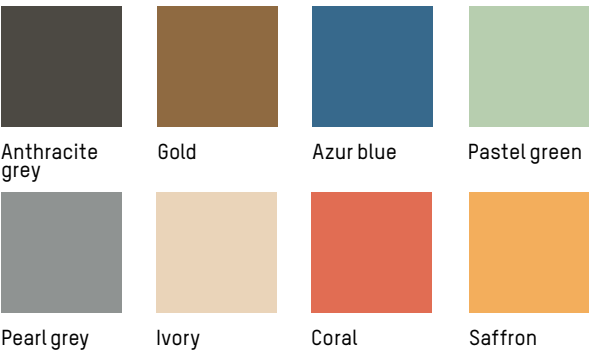

FOR CONTRACT PROJECT WITH MINIMUM QUANTITY

Coffee tables

MATERIALS

Aluminium, matte grained Anti UV powder coating for outdoor use

COLOURS

Anthracite grey, Gold, Azur blue, Pastel green, Pearl grey, Ivory, Coral, Saffron

ORIGIN

China

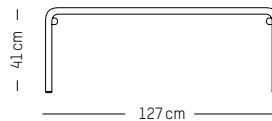
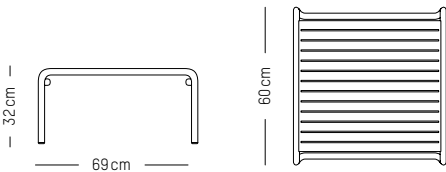

Coffee table

W: 60 cm | 23.6 inch
L: 69 cm | 27.2 inch
H: 32 cm | 12.6 inch
Weight: 4 kg | 8.8 lb

PACKAGING :

L: 72 cm | 28.3 inch
W: 72 cm | 28.3 inch
H: 35 cm | 13.8 inch
Weight : 5 kg | 11 lb

Long coffee table

W: 127 cm | 50 inch
L: 51 cm | 20 inch
H: 41 cm | 16.1 inch
Weight: 5 kg | 11 lb

PACKAGING :

L: 130 cm | 51.2 inch
W: 58 cm | 22.8 inch
H: 45 cm | 17.7 inch
Weight: 6 kg | 13.6 lb

STUDIO BRICHET ZIEGLER

2017



Dining tables

MATERIALS

Aluminium, matte grained Anti UV powder coating for outdoor use

COLOURS

Anthracite grey, Gold, Azur blue, Pastel green, Pearl grey, Ivory, Coral, Saffron

ORIGIN

China

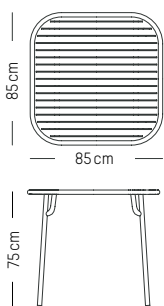

Square table

L: 85 cm | 33.5 inch
W: 85 cm | 33.5 inch
H: 75 cm | 29.5 inch
Weight: 12 kg | 26.5 lb

PACKAGING :

packaging tabletop
L: 86 cm | 33.9 inch
W: 86 cm | 33.9 inch
H: 5 cm | 2 inch
Weight: 10 kg | 22 lb

packaging legs (x2)
L: 19 cm | 7.5 inch
W: 19 cm | 7.5 inch
H: 80 cm | 31.5 inch
Weight: 4 kg | 8.9 lb

Assembly

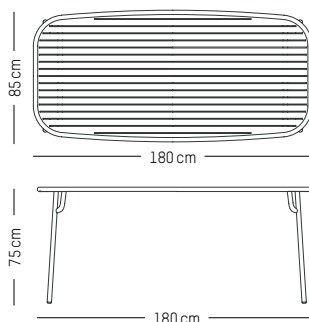

Rectangular table medium

W: 85 cm | 33.5 inch
L: 180 cm | 70.9 inch
H: 75 cm | 29.5 inch
Weight: 22,3 kg | 49.2 lb

PACKAGING :

packaging table top
L: 182 cm | 71.7 inch
W: 88 cm | 34.6 inch
H: 5 cm | 2 inch
Weight: 22 kg | 48.5 lb

packaging legs (x2)
L: 19 cm | 7.5 inch
W: 19 cm | 7.5 inch
H: 80 cm | 31.5 inch
Weight: 4 kg | 8.9 lb

Assembly

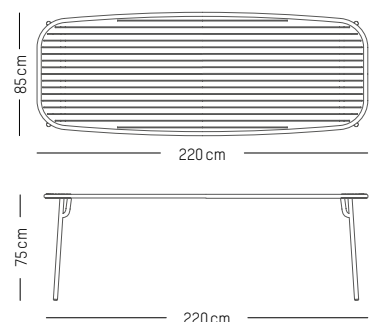

Rectangular table large

W: 85 cm | 33.5 inch
L: 220 cm | 86.6 inch
H: 75 cm | 29.5 inch
Weight: 27 kg | 59.5 lb

PACKAGING :

packaging table top
L: 222 cm | 87.4 inch
W: 88 cm | 34.6 inch
H: 5 cm | 2 inch
Weight: 27 kg | 59.5 lb

packaging legs (x2)
L: 19 cm | 7.5 inch
W: 19 cm | 7.5 inch
H: 80 cm | 31.5 inch
Weight: 4 kg | 8.9 lb

Assembly

WEEK - END

STUDIO BRICHET ZIEGLER

2019

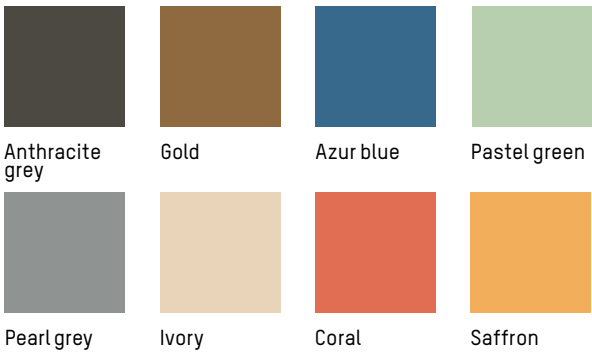

FOR CONTRACT PROJECT WITH MINIMUM QUANTITY

Bistro tables

-

MATERIALS

Aluminium, matte grained Anti UV powder coating for outdoor use

COLOURS

Anthracite grey, Gold, Azur blue, Pastel green, Pearl grey, Ivory, Coral, Saffron

ORIGIN

China

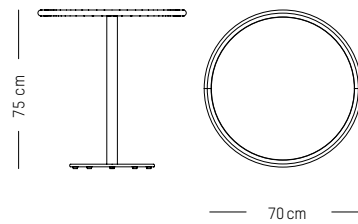
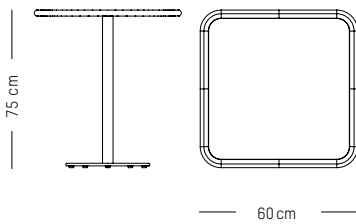

Square bistro table

-

L: 60 cm | 27.5 inch
W: 60cm | 27.5 inch
H: 75 cm | 29.5 inch
Weight: 11 kg | 24.2 lb

PACKAGING :

L: 72 cm | 28.3 inch
W: 72 cm | 28.3 inch
H: 78 cm | 30.7 inch
Weight: 14 kg | 30.9 lb

Assembly

Round bistro table

-

Ø: 70 cm | 23.6 inch
L: 70 cm | 23.6 inch
H: 75 cm | 29.5 inch
Weight: 10 kg | 22 lb

PACKAGING :

L: 73 cm | 29 inch
W: 73 cm | 29 inch
H: 78 cm | 30.7 inch
Weight: 12 kg | 26.5 lb

Assembly

WEEK - END

STUDIO BRICHET ZIEGLER

2019



FOR CONTRACT PROJECT WITH MINIMUM QUANTITY

High tables

MATERIALS

Aluminium, matte grained Anti UV powder coating for outdoor use

COLOURS

Anthracite grey, Gold, Azur blue, Pastel green, Pearl grey, Ivory, Coral, Saffron

ORIGIN

China

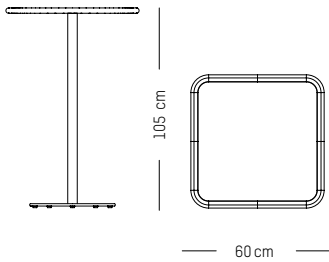

High table square

L: 60 cm | 27.5 inch
W: 60cm | 27.5 inch
H: 105 cm | 41.3 inch
Weight: 13 kg | 29 lb

PACKAGING :

L: 72 cm | 28.3 inch
W: 72 cm | 28.3 inch
H: 108 cm | 42.5 inch
Weight: 15 kg | 33 lb

Assembly

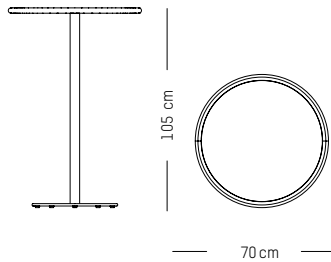

High table round

Ø: 70 cm | 23.6 inch
L: 70 cm | 23.6 inch
H: 105 cm | 41.3 inch
Weight: 12 kg | 26.4 lb

PACKAGING :

L: 73 cm | 29 inch
W: 73 cm | 29 inch
H: 108 cm | 42.5 inch
Weight: 14 kg | 30.9 lb

Assembly



DECORATION

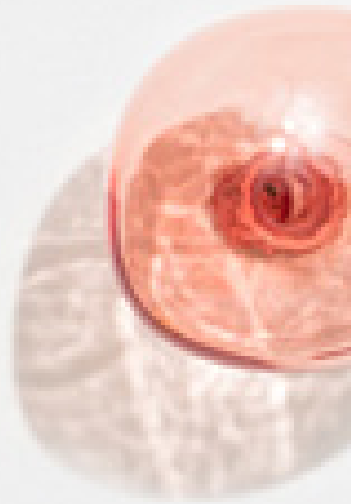

BUBBLE

VAULOT & DYÈVRE

2013

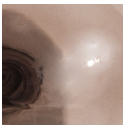

Grey

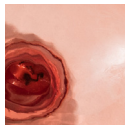

Coral



Yellow

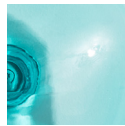

Blue

Hooks

-

MATERIALS

Hook in blown glass, Fixing system in steel

COLORS

Grey, Coral, Yellow, Blue

ORIGIN

Europe

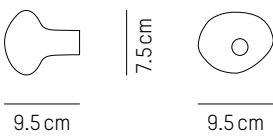

Small

-

L: 9,5 cm | 3.7 inch

W: 9,5 cm | 3.7 inch

H: 7,5 cm | 2.3 inch

Weight: 0,25 kg | 0.5 lb

PACKAGING :

L: 12 cm | 5 inch

W: 12 cm | 5 inch

H: 16 cm | 6.3 inch

Weight: 0,5 kg | 1.1 lb

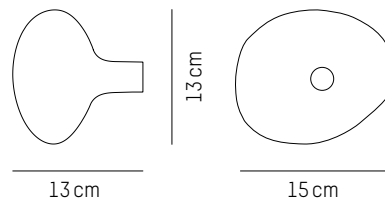

Large

-

L: 13cm | 5.12 inch

W: 13 cm | 5.12 inch

H: 15 cm | 5.9 inch

Weight: 0,8 kg | 1.8 lb

PACKAGING :

L: 16,5 cm | 6.5 inch

W: 16,5 cm | 6.5 inch

H: 22,5 cm | 8.9 inch

Weight: 1 kg | 2.2 lb

DONUT

PIA CHEVALIER

2022



Vanilla



Bubble Gum



Cherry



Blueberry



Lemon



Pistachio

Tableware

-

MATERIALS

Earthenware, white body and enamel.

COLORS

Espresso cup and mug: Vanilla, Bubble Gum, Cherry, Blueberry, Lemon and Pistachio

L mug: Vanilla and Pistachio

ORIGIN

Europe

TECHNICAL SPECIFICATIONS

Food compliance European tests :Lead and cadmium tests

+ Aluminium, Cobalt and Arsenic tests

- (EC) 1935/2004/EC

- (EC) No 2023/2006

Food compliance American tests : Lead and cadmium tests

- FDA (Food and Drug administration) Title 21 Code of Federal Regulations (CFR, 2011 Edition)

FOOD SAFE

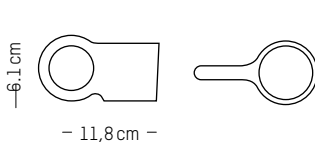

Espresso cup (set of 2 pcs)

-

Ø : 6,1cm | 2.5 inch

H: 5,6 cm | 2.4 inch

Weight: 0,15 kg | 0.2 lb

PACKAGING (Cash&Carry = 1 set)

L: 17 cm | 6.7 inch

W: 15 cm | 6 inch

H: 9 cm | 3.6 inch

Weight: 0,4 kg | 0.9 lb

Master Pack (2 cash&carry)

L: 31 cm | 12.2 inch

W: 19 cm | 7.5 inch

H: 4 cm | 1.6 inch

Weight: 1 kg | 2.2 lb

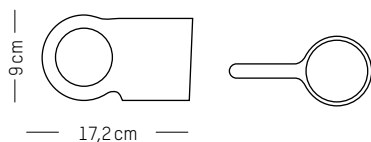

M Mug

-

Ø : 8,3 cm | 4 inch

H: 9 cm | 3.6 inch

Weight : 0,4 kg | 0.9 lb

PACKAGING (Cash&Carry = 1 M)

L: 22 cm | 8.7 inch

W: 12 cm | 4.8 inch

H: 13 cm | 5.2 inch

Weight: 0,4 kg | 0.9 lb

Master Pack (2 cash&carry)

L: 25 cm | 9.9 inch

W: 25 cm | 9.9 inch

H: 14 cm | 5.6 inch

Weight: 1 kg | 2.2 lb

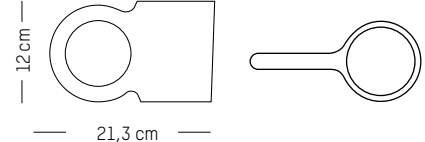

L Mug

-

Ø : 9,2 cm | 4 inch

H: 12 cm | 3.6 inch

Weight : 0,4 kg | 0.9 lb

PACKAGING (Cash&Carry = 1 L)

L: 26 cm | 10.3 inch

W: 13 cm | 5.2 inch

H: 15 cm | 6 inch

Weight: 0,6 kg | 1.4 lb

Master Pack (2 cash&carry)

L: 28 cm | 11.1 inch

W: 27 cm | 10.7 inch

H: 16 cm | 6.3 inch

Weight: 1,4 kg | 3.1 lb

PING *

ANDRAS RIGLER

2018



Containers

-

MATERIALS

Ceramic

COLORS

White

ORIGIN

Europe

119

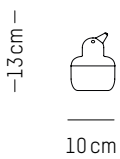

Baby ping

-

Ø: 10 cm | 3.9 inch
H: 13 cm | 5.1 inch
Weight: 0,3 kg | 0.7 lb

PACKAGING :

L: 17 cm | 6.7 inch
W: 17 cm | 6.7 inch
H: 22,5 cm | 8.9 inch
Weight: 0.5 kg | 1.1 lb

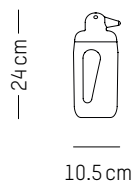

Mama ping

-

Ø: 10,5 cm | 3.9 inch
H: 24 cm | 9.4 inch
Weight: 0,6 kg | 1.4 lb

PACKAGING :

L: 17 cm | 6.7 inch
W: 17 cm | 6.7 inch
H: 43 cm | 16.9 inch
Weight: 0.86 kg | 1.9 lb

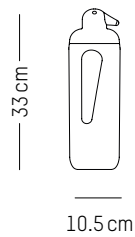

Papa ping

-

Ø: 10,5 cm | 3.9 inch
H: 33 cm | 13 inch
Weight: 0,9 kg | 1.9 lb

PACKAGING :

L: 17 cm | 6.7 inch
W: 17 cm | 6.7 inch
H: 43 cm | 16.9 inch
Weight: 1,3 kg | 2.9 lb

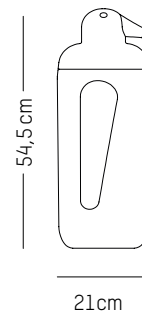

Grand pa ping

-

Ø: 21 cm | 8.3 inch
H: 54,5 cm | 21.3 inch
Weight: 4,5 kg | 9.9 lb

PACKAGING :

L: 30 cm | 11.8 inch
W: 30 cm | 11.8 inch
H: 60 cm | 23.6 inch
Weight: 5.5 kg | 13 lb

* While stocks last

SUCCESSION *

FÄRG & BLANCHE

2016



Tableware

-

MATERIALS

Culinary porcelain

COLORS

Black, White

ORIGIN

Europe

TECHNICAL SPECIFICATIONS

FOOD SAFE

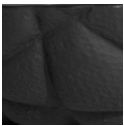

Black



White

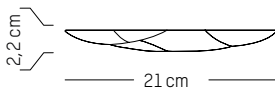

Small plate (by 6)

-

Ø: 21 cm | 8.3 inch
H: 2,2 cm | 0.9 inch
Weight: 0,4 kg | 0.9 lb

PACKAGING :

L: 22 cm | 8.7 inch
W: 22 cm | 8.7 inch
H: 10 cm | 3.9 inch
Weight: 3 kg | 6.6 lb

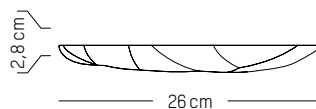

Large plate (by 6)

-

Ø: 26 cm | 10.2 inch
H: 2,8 cm | 1.1 inch
Weight: 0,7 kg | 1.5 lb

PACKAGING :

L: 29 cm | 11.4 inch
W: 29 cm | 11.4 inch
H: 11 cm | 4.3 inch
Weight: 5,5 kg | 12.1 lb

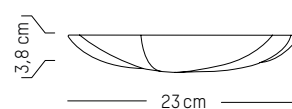

Soup plate (by 6)

-

Ø: 23 cm | 9.1 inch
H: 3,8 cm | 1.5 inch
Weight: 0,6 kg | 1.3 lb

PACKAGING :

L: 28,5 cm | 11.2 inch
W: 28,5 cm | 11.2 inch
H: 11 cm | 4.3 inch
Weight: 3,7 kg | 8.2 lb

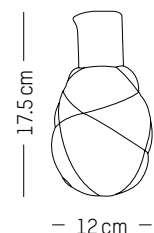

Pitcher

-

Ø: 12 cm | 4.7 inch
H: 17,5 cm | 6.9 inch
Weight: 0,8 kg | 1.7 lb

PACKAGING :

L: 20 cm | 7.9 inch
W: 12,5 cm | 4.9 inch
H: 14 cm | 5.5 inch
Weight: 0,9 kg | 2 lb

* While stocks last

SUCCESSION *

FÄRG & BLANCHE

2016

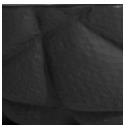

Black



White

Tableware

-

MATERIALS

Culinary porcelain

COLORS

Black, White

ORIGIN

Europe

TECHNICAL SPECIFICATIONS

FOOD SAFE

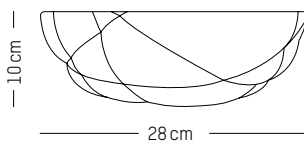

Serving bowl

-

Ø: 28 cm | 11 inch

H: 10 cm | 3.9 inch

Weight: 1,6 kg | 3.9 lb

PACKAGING :

L: 32 cm | 12.6 inch

W: 32 cm | 12.6 inch

H: 11 cm | 4.3 inch

Weight: 1,8 kg | 4 lb

* While stocks last

CONSTELLATION 1 AND 2 *

LESLIE DAVID

2017



CONSTELLATION 1



Ink

CONSTELLATION 2



Cream

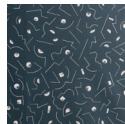

Ink

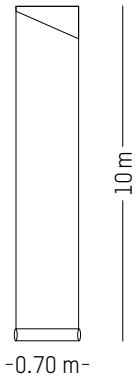

L: 1000 cm | 393.7 inch
W: 70 cm | 27.6 inch
Weight: 1 kg | 2.2 lb

PACKAGING :

Ø: 13,6 cm | 5.3 inch
H: 74 cm | 29.1 inch
Weight: 1.2 kg | 2.6 lb

Wallpaper

-

MATERIALS

Non-woven wallpaper 1476/M2

COLORS

Cream, Ink

ORIGIN

France

TECHNICAL SPECIFICATIONS

CERTIFICATION EUROCLASS B-S1,D0

 Apply Paste to the wall

 Dry peelable

 Light-proof

 Washable

DOTS *

SHELLEY STEER

2017

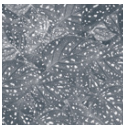

White on
black

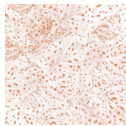

Copper

Wallpaper

-

MATERIALS

Non-woven wallpaper 1476/M2

COLORS

Black, Copper

ORIGIN

France

TECHNICAL SPECIFICATIONS

CERTIFICATION EUROCLASS B-S1,D0

 Apply Paste to the wall

 Dry peelable

 Light-proof

 Washable

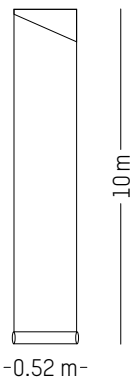

L: 1000 cm | 393.7 inch

W: 52 cm | 20.5 inch

Weight: 1 kg | 2.2 lb

PACKAGING :

Ø: 13,6 cm | 5.3 inch

H: 74 cm | 29.1 inch

Weight: 1.2 kg | 2.6 lb

JUNGLE

TIPHAINE DE BODMAN

2015



White on black



Black



Copper



Ink

Wallpaper

-

MATERIALS

Non-woven wallpaper 1476/M2

COLORS

White on black, Black, Copper, Ink

ORIGIN

France

TECHNICAL SPECIFICATIONS

CERTIFICATION EUROCLASS B-S1,D0

 Apply Paste to the wall

 Dry peelable

 Light-proof

 Washable

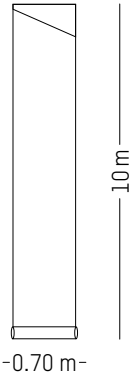

L: 1000 cm | 393.7 inch

W: 70 cm | 27.6 inch

Weight: 1 kg | 2.2 lb

PACKAGING :

Ø: 13,6 cm | 5.3 inch

H: 74 cm | 29.1 inch

Weight: 1.2 kg | 2.6 lb

JUNGLE *

TIPHAINE DE BODMAN

2015



Napkin

-

MATERIALS

Paper

COLORS

White on black

ORIGIN

France

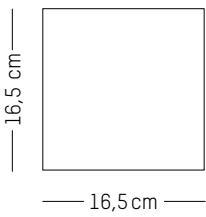

L: 16,5 cm | 7 inch
W: 16,5cm | 7 inch
Weight: 0.5 kg | 1.1 lb

* While stocks last

MINERALS *

SHELLEY STEER

2017



Black-pink



Turquoise-Coral

Wallpaper

-

MATERIALS

Non-woven wallpaper 1476/M2

COLORS

Black-pink, Turquoise-Coral,

ORIGIN

France

TECHNICAL SPECIFICATIONS

CERTIFICATION EUROCLASS B-S1,D0

 Apply Paste to the wall

 Dry peelable

 Light-proof

 Washable

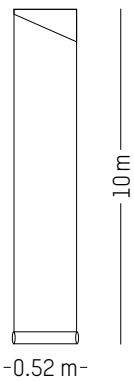

L: 1000 cm | 393.7 inch

W: 52 cm | 20.5 inch

Weight: 1 kg | 2.2 lb

PACKAGING :

Ø: 13,6 cm | 5.3 inch

H: 74 cm | 29.1 inch

Weight: 1.2 kg | 2.6 lb

UTOPIA ASCENDING *

ANA MONTIEL

2017



Cream



Ink

Wallpaper

-

MATERIALS

Non-woven wallpaper 1476/M2

COLORS

Cream, Ink

ORIGIN

France

TECHNICAL SPECIFICATIONS

CERTIFICATION EUROCLASS B-S1,D0

 Apply Paste to the wall

 Dry peelable

 Light-proof

 Washable

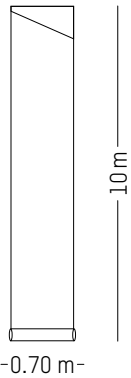

L: 1000 cm | 393.7 inch

W: 70 cm | 27.6 inch

Weight: 1 kg | 2.2 lb

PACKAGING :

Ø: 13,6 cm | 5.3 inch

H: 74 cm | 29.1 inch

Weight: 1.2 kg | 2.6 lb

VARIATIONS

TIPHAINE DE BODMAN

2014

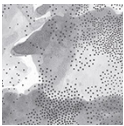

Black

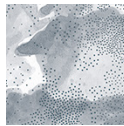

Ink

Wallpaper

-

MATERIALS

Non-woven wallpaper 1476/M2

COLORS

Black, Ink

ORIGIN

France

TECHNICAL SPECIFICATIONS

 Apply Paste to the wall

 Dry peelable

 Light-proof

 Washable

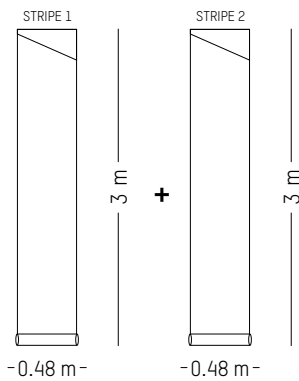

Ø: 300 cm | 118.1 inch
W: 48cm | 18.9 inch
Weight: 0,3 kg | 0.6 lb

PACKAGING :

Ø : 10 cm | 3.9 inch
H : 51,5 cm | 20.3 inch
Weight: 0,5 kg | 1.1 lb

VOLUTES*

TIPHAINE DE BODMAN

2017



Black

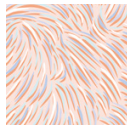

Pink

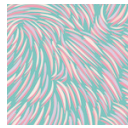

Green

Wallpaper

-

MATERIALS

Non-woven wallpaper 1476/M2

COLORS

Black, Pink, Green

ORIGIN

France

TECHNICAL SPECIFICATIONS

CERTIFICATION EUROCLASS B-S1,D0

 Apply Paste to the wall

 Dry peelable

 Light-proof

 Washable

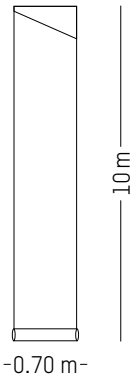

L: 1000 cm | 393.7 inch

W: 70 cm | 27.6 inch

Weight: 1 kg | 2.2 lb

PACKAGING :

Ø: 13,6 cm | 5.3 inch

H: 74 cm | 29.1 inch

Weight: 1.2 kg | 2.6 lb

Petite Friture

PETITE FRITURE

45 TER RUE DE LA REVOLUTION 93100 MONTREUIL
T + 33 (0)1 44 54 13 95

SAS au capital de 85 778€ - R.C.S Paris 513 649 343

www.petitefriture.com