

INNOVATION LIVING™

The Danish sofa bed specialist established in 1971



Expand Your  
Living Space  
In Style

# Space saving designs for your home

Innovation Living™ is a Danish sofa bed specialist built on the proud Danish tradition of furniture design. We believe that form and function must go hand in hand to create innovative, durable designs for everyday use. Since 1971 we have dedicated ourselves to the design and development of multifunctional sofa beds, and today we are proud to be able to call Innovation Living™ an internationally renowned sofa bed specialist.

# A splash of color in a grey world

CARPE DIEM - Seize the day. Let's celebrate life with encouraging colors and patterns.

This collection is intended as inspiration, as an invitation to remember the playfulness and the cheerful, joie de vivre expression in our physical surroundings. It could be a piece of furniture with a colorful textile, or simply be colorful accents in the surroundings that set a different setting for a piece of grey furniture.

Per Weiss,  
Chief Design Officer

# Comfort is always at the center of our design process

A design's aesthetic expression will, to some extent, be decisive for the product's comfort. The elegant slim design will quite naturally tend to be firmer than the large bulky design.

Our design process centers around comfort, as we aim to deliver the best possible comfort with each design.



The Patchwork Project	8
Designed for Longevity	14
Environmental Considerations	16
Deco Stitch	18
The Soft Touch	20
The Scandinavian Touch	48
European Modernism	84
Mid-Century Modern	126
Designers	148
Chairs & Floorlife	150-152
Cushions & Headrest	153
Coffee Tables	154-155
Comfort	156-161
Fabric Specifications & Fabrics	162-163

# Index by product name

Aslak	74	Narvi	122
Balder	66	Newilla	24
Bifrost D.E.L.	124	Newilla with lounger	26
Bragi	116	Nolis	60
Cassius D.E.L.	100	Nordham	104
Colpus	146	Olan	42
Conlix	142	Osvald	32
Conlix Patchwork	10	Pascala	38
Cornila	34	Puri	14
Cosial	28-31	Pyxis D.E.L.	72
Cubed Alu	88	Recast Dark Styletto	138
Cubed Chrome	90	Recast Light Styletto	140
Cubed with arms	92	Rollo Stem	68
Cubed Wood	58	Sigga X	18
Dublexo Dark Styletto	134	Sigmund Drip	70
Dublexo Eik Oak	55	Sigmund Indu	114
Dublexo Frej & Eik Oak	52	Sly	118
Dublexo Stem	57	Sly Wood	76
Eivor	44	Splitback Chrome with arms	86
Eluma Deluxe Button	64	Splitback Dark Styletto	132
Fraction	120	Splitback Eik Smoked Oak	54
Frode & Frode with arms	82	Splitback Frej & Eik Smoked Oak	50
Ghia Chrome	96	Splitback Stem	56
Ghia Laser	97	Supremax D.E.L.	98
Ghia Wood	69	Tripi	34
Idun	78	Trym	77
Junus	112	Unfurl	130
Killian	46	Unfurl Lounger	128
Long Horn D.E.L.	106	Vanadis	144
Luoma	108	Vikko	150
Malloy	110	Vogan	36
Malloy Wood	62	Vogan Lounger	36
Merga	40	Yonata	22
Mimer	80	Zeal Laser	95
Minimum	102	Zeal Straw	94
Multifunctionals Patchwork	12	Zeal Styletto	136

## Much more information about each design online

Scan the QR code at the bottom of each page to access our visualizer and view the full product presentation.

### View the sofa from all angles in your favorite fabric

CHOOSE FABRIC <sup>⌵</sup> 586 Phobos Latte ✓

Standard (2-4 Weeks) <sup>⌵</sup>

Made-to-order (13-15 Weeks) <sup>⌵</sup>

Go to detailed fabric overview <sup>➤</sup>

Please note that your screen presentation of the fabric texture and color may vary from the actual fabric.

FIND DEALER SEND AS E-MAIL

- Find detailed information about each product
- Evaluate the product from all angles in the visualizer
- View a video demonstration of the functionality of the product
- View the product in your favorite fabric



## Revitalizing excess fabrics

The Patchwork Project is a collection of limited edition striped patchwork covers made from excess fabrics.

Each textile combination has a limited number of covers based on remaining stock of textile. Please visit our website to see the available covers.

The covers are detachable, washable, and interchangeable with any standard cover for Conlix or any Multifunctionals when worn, or if times call for a more understated cover.



# Conlix Patchwork

Design by Per Weiss 2022

Bed size 140 x 200 cm | Metal frame with Pocket Spring comfort, see page 156 | Trumpet legs in black lacquered oak | Detachable and washable covers made of excess fabrics | Bedding box | Page 09: Shown in Patchwork Blue cover | Page 10: Shown in Patchwork Blue and Green cover | Page 11: Shown in Patchwork Red cover | Shown Patchwork covers: 2-4 weeks delivery time | The Patchwork covers are only available for Conlix | Scan the QR code to see additional features at our website



# Multifunctionals Patchwork

Design by Per Weiss 2022

Bed size 140 x 200 cm | Metal frame with beech wood slats | Available for all Multifunctional comforts, see page 160 | Back frame cover included | Optional seat frame cover | Bedding box | Detachable and washable covers and frame covers made of excess fabrics | Shown combination: Page 12: Fraction 140 frame, Soft Spring mattress and Patchwork Green cover and Blue cover | Shown combinations: Page 13: Fraction 140 frame, Soft Spring mattress and Patchwork Red cover | Shown Patchwork covers: 2-4 weeks delivery time | The Patchwork covers are only available for Aslak 140, Balder, Colpus, Fraction 140, Minimum and Junus | Scan the QR code to see additional features at our website

Multifunctionals Patchwork is part of the Multifunctionals assortment and has several options of mattress comfort and cover styles, see page 160-161



# Puri

## Designed for Longevity

Design by Per Weiss 2021

Puri is our take on a design where every detail and material has been carefully evaluated and prioritized with sustainability in mind.

Puri has been designed for maintenance and long life cycle. The frame is made of a durable metal construction, and the covers are detachable, washable, and renewable. The OEKO-TEX® high resilient foam filling of the seats and cushion can also be replaced over time. Puri is designed for disassembly and recycling, and is flat packed to minimize transportation volume. The recommended fabrics are made from recycled fibers.

Bed size 80 x 195 cm | Matt black metal frame with a mattress made of OEKO-TEX® high resilient foam, see page 158 | One back cushion included | Table top in lacquered oak or lacquered walnut | Detachable and washable covers | Shown in 536 Bouclé Ochre | Shown fabrics: 2-4 weeks delivery time | Other fabric options with 6-8 weeks delivery time, see page 163 | Scan the QR code to see additional features at our website

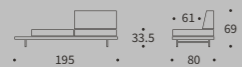

Oak table

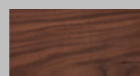

Walnut table





# Environmental Considerations

## Give back to nature

To contribute to the balance of the global ecosystem, Innovation Living plants more than 10.000 new trees every year to compensate for our consumption of wood.

## Detachable covers

As it offer obvious benefits, a growing part of our collection comes with detachable and washable covers. The sofa is easy to maintain as covers can be machine washed at 30 degrees Celsius. Upholstery can be replaced if it is worn out, or if you want to freshen up your sofa. Instead of replacing the entire sofa, this will create a significantly smaller impact on the environment.

## Products available with detachable covers:

Aslak, Balder, Colpus, Conlix, Conlix Patchwork, Fraction, Idun, Junus, Merga, Mimer, Minimum, Multifunctionals Patchwork, Narvi, Newilla, Newilla with lounger, Pascala, Pauke, Puri, Rollo, Soft Peak, Triangular, Trym and Yonata.

Look for this icon:



## Fabrics

As not all designs are suitable for removable covers, the durability of the fabric and ease of cleaning become crucial for the longevity of each design. All fabrics are highly durable and upgraded by adding backsides to strengthen them even further. All fabrics can withstand washing at 30 degrees Celsius, which means that products can withstand wet cleaning. Finally, most of our fabrics are OEKO-TEX® Standard 100 certified, signifying that they are free of harmful substances.

## Recycled fabrics

The supply of fabrics made from recycled fibers is fortunately constantly increasing. More than 1/3 of our quality fabrics are made from recycled polyester which can for instance be recycled plastic bottles. Please look for Bouclé, Vivus and Argus fabrics - see page 163.

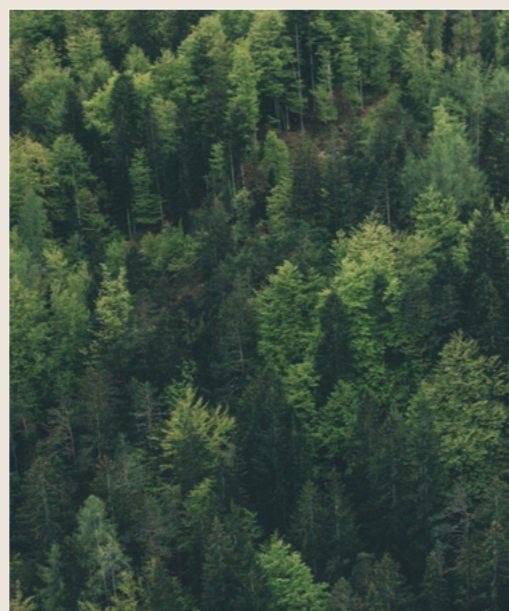

## Lower CO<sub>2</sub> footprint

Since 1989, all our products have been designed for flat packing, which minimizes CO<sub>2</sub> emissions during transportation and storage. We continuously work to reduce the environmental impact of our activities, and you can read more about our specific initiatives on our website. Although we are not CO<sub>2</sub> neutral, we are committed to minimizing our CO<sub>2</sub> footprint.

## Maintain and refresh

Designing for flat packing means creating a set of parts that easily combine into a full product. The complexity and number of parts vary from product to product, but the design strategy allows for easy replacement of components to prolong a product's life cycle - whether it is to replace a worn-out part or refresh product's appearance.

## Disassembly and recycling

In our design process, we focus on the ability to disassemble our products and materials after their life cycle ends. We carefully consider which materials to use, how to combine them, and how to separate them into individual parts for recycling. Each design presents a unique challenge, and some are more suitable for disassembly than others, but the ECO-dimension is always an integral part of our design philosophy.

## Durability | 5 years warranty

Quality and durability are at the center of our design and production process. We offer a 5 year warranty on all designs and a lifetime warranty on slats and gears for all sofa beds in our Multifunctionals category. For further information about our warranty, please visit our website.

## Certified production facilities

We engage in the development of local communities to contribute to a better tomorrow in the areas we operate in. To ensure ongoing improvement, our production facilities undergo continuous audits to confirm that our group values and working conditions are upheld, as outlined by third-party standards such as the amfori BSCI Code of Conduct. In addition our production units are also FSC®-certified.

For more information about our standards and principles, please visit our website.

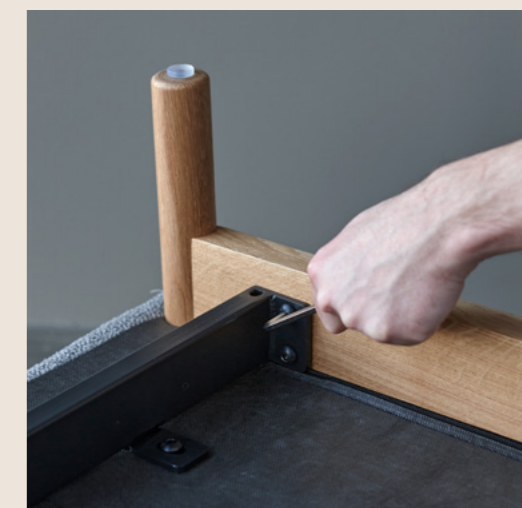

amfori  BSCI  
Trade with purpose



The mark of  
responsible forestry  
FSC® C174105

# A sophisticated detail that makes a difference



## Sigga X

Design by Per Weiss 2022

Bed size 137 x 190 cm | Metal frame with Pocket Spring comfort, see page 156 | Legs in matt black steel | Bedding box | Only available in shown fabrics 300 Weda Sand and 302 Weda Blue | Delivery time: 2-4 weeks | Scan the QR code to see additional features at our website

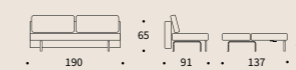

## The Soft Touch

A selection of minimalist designs with a soft and voluminous character.





# Yonata

Design by Emil Højfeldt & Per Weiss 2021

Bed size 145 x 200 cm | Metal frame with Excess Pocket Spring comfort, see page 156 | Legs in matt black aluminum | Detachable and washable covers | Shown in 586 Phobos Latte | Shown fabrics: 2-4 weeks delivery time | Other fabric options with 13-15 weeks delivery time, see page 163 | Scan the QR code to see additional features at our website

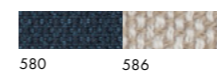



# Newilla

Design by Per Weiss 2022

Bed size 145 x 200 cm | No-zag and Pocket Spring comfort with hyper soft foam, see page 157 | Integrated storage | Detachable and washable covers | Optional headrest | Shown in 594 Corduroy Ivory | Shown fabrics: 2-4 weeks delivery time | Other fabric options with 6-8 weeks delivery time, see page 163 | Scan the QR code to see additional features at our website

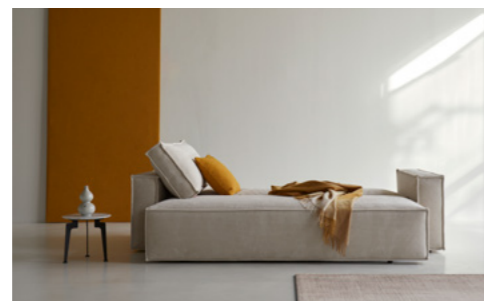
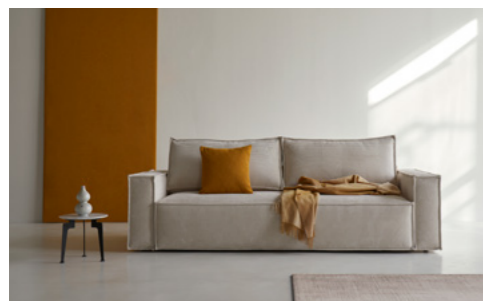

# Newilla with lounger

Design by Per Weiss 2022

Bed size 145 x 300 cm | No-zag and Pocket Spring comfort with hyper soft foam, see page 157 | Integrated storage | Lounger is Left/right reversible | Detachable and washable covers | Optional headrest | Shown in 530 Bouclé Taupe | Shown fabrics: 2-4 weeks delivery time | Other fabric options with 6-8 weeks delivery time, see page 163 | Scan the QR code to see additional features at our website

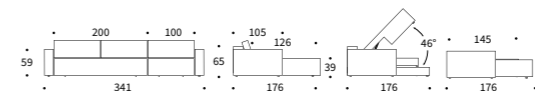
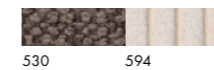



# Cosial

Design by Per Weiss 2021

Bed sizes 80 x 195 cm, 140 x 195 cm, 160 x 195 cm and 180 x 195 cm | Metal frame with Pocket Spring comfort, see page 156 | Optional headrest | Shown in size 180 cm in 586 Phobos Latte | Shown fabrics: 2-4 weeks delivery time | Other fabric options with 13-15 weeks delivery time, see page 163 | Scan the QR code to see additional features at our website

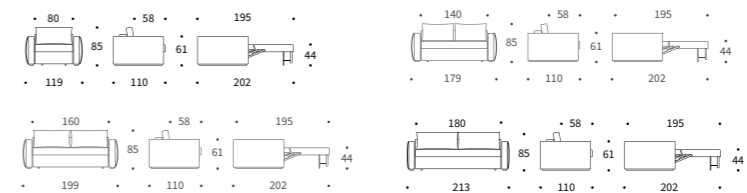
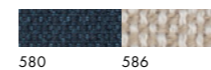

# Cosial

Design by Per Weiss 2021

Bed sizes 80 x 195 cm, 140 x 195 cm, 160 x 195 cm and 180 x 195 cm | Metal frame with Pocket Spring comfort, see page 156 | Optional headrest | Page 30: Shown in 80, 140, 160, 180 cm in 586 Phobos Latte | Page 31: Shown in 80 cm in 580 Argus Navy Blue | Shown fabrics: 2-4 weeks delivery time | Other fabric options with 13-15 weeks delivery time, see page 163 | Scan the QR code to see additional features at our website

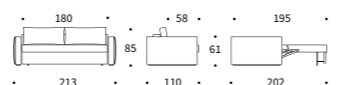
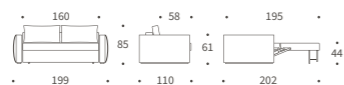
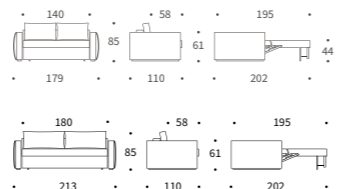
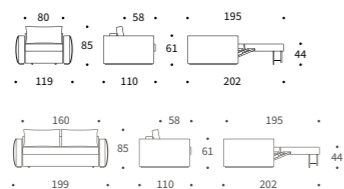
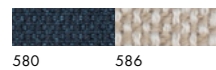



# Osvald

Design by Emil Højfeldt & Per Weiss 2015, 2018

Bed size 150 x 200 cm | Cornila ottoman size 75 x 75 cm | Metal frame with Pocket Spring Dual comfort, see page 156 | Integrated storage in sofa bed and ottoman | Optional headrest | Shown in 535 Bouclé Forest Green | Shown fabrics: 2-4 weeks delivery time | Other fabric options with 6-8 weeks delivery time, see page 163 | Scan the QR code to see additional features at our website



# Tripi & Cornila

Design by Emil Højfeldt & Per Weiss 2015, 2016, 2018

Bed size 150 x 200 cm | Cornila ottoman size 75 x 75 cm | Metal frame with Pocket Spring Dual comfort, see page 156 | Integrated storage in sofa bed and ottoman | Optional headrest | Page 34: Tripi and Cornila shown in 318 Cordufine Beige | Page 35: Tripi and Cornila shown in 565 Twist Granite | Shown fabrics: 2-4 weeks delivery time | Other fabric options with 6-8 weeks delivery time, see page 163 | Scan the QR code to see additional features at our website

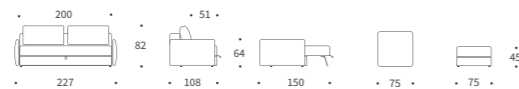

# Vogan & Vogan Lounger

Design by Oliver & Lukas WeissKrogh 2017, 2019

Bed size 120 x 200 cm | 80 cm seat module available in 2 depths, 120 cm or 160 cm | Metal frame with Excess Pocket Spring comfort, see page 156 | Back shelf in black lacquered oak | Shown in 539 Bouclé Beige | Shown fabric: 2-4 weeks delivery time | Other fabric options with 13-15 weeks delivery time, see page 163 | Scan the QR code to see additional features at our website



539





# Pascala

Design by Per Weiss 2021

Bed size 140 x 200 cm | Metal frame with Pocket Spring comfort, see page 156 | Detachable and washable covers | Bedding box | Shown in 574 Vivus Off White | Shown fabrics: 2-4 weeks delivery time | Other fabric options with 6-8 weeks delivery time, see page 163 | Scan the QR code to see additional features at our website

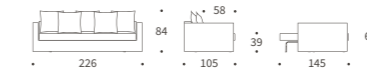



# Merga

Design by Emil Højfeldt & Per Weiss 2020

Bed size 140 x 200 cm | No-zag and Pocket Spring comfort with hyper soft foam, see page 157 | Legs in black lacquered oak | Detachable and washable covers | Integrated storage | Shown in 536 Bouclé Ochre | Optional headrest | Shown fabrics: 2-4 weeks delivery time | Other fabric options with 6-8 weeks delivery time, see page 163 | Scan the QR code to see additional features at our website

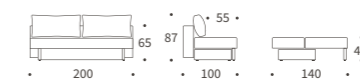
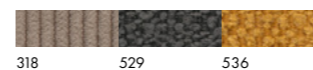

# Olan

Design by Per Weiss 2017

Bed size 140 x 195 cm | No-zag Spring with high resilient foam comfort, see pages 156 | Shown in 565  
Twist Granite | Shown fabric: 2-4 weeks delivery time | Other fabric options with 6-8 weeks delivery time,  
see page 163 | Scan the QR code to see additional features at our website



565

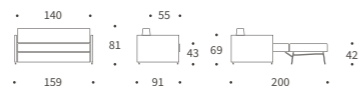



# Eivor

Design by Per Weiss 2017

Bed sizes 140 x 195 cm and 160 x 195 cm | Metal frame with 5-zone Multi-Pocket Spring or Dual Memory mattress, see page 158 | Shown in size 140 cm in 565 Twist Granite | Shown fabrics: 2-4 weeks delivery time | Other fabric options with 6-8 weeks delivery time, see page 163 | Scan the QR code to see additional features at our website

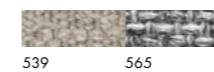



# Killian

Design by Per Weiss 2019

Bed sizes 140 x 195 cm and 160 x 195 cm | Metal frame with 5-zone Multi-Pocket Spring or Dual Memory mattress, see page 158 | Shown in size 160 cm in 539 Bouclé Beige | Shown fabrics: 2-4 weeks delivery time | Other fabric options with 6-8 weeks delivery time, see page 163 | Scan the QR code to see additional features at our website



539 565





## The Scandinavian Touch

A range characterized by carefully crafted signature wood details designed with reference to the internationally acclaimed Scandinavian interpretation of early European modernism.



# Splitback Frej & Eik Smoked Oak

Design by Per Weiss, Oliver & Lukas WeissKrogh 2004, 2015

Bed size 115 x 210 cm | Chair size 115 x 90 cm | Metal frame with Pocket Spring comfort, see page 156 |  
Legs shown in smoked oak | Shown in 580 Argus Navy Blue | Shown fabrics: 2-4 weeks delivery time |  
Other fabric options with 13-15 weeks delivery time, see page 163 | Scan the QR code to see additional  
features at our website

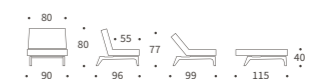

# Dublexo Frej & Eik Oak

Design by Per Weiss, Oliver & Lukas WeissKrogh 2011, 2015

Bed size 115 x 210 cm | Chair size 115 x 90 cm | Metal frame with Pocket Spring Dual comfort, see page 156 | Legs shown in lacquered oak | Shown in 527 Mixed Dance Natural | Shown fabrics: 2-4 weeks delivery time | Other fabric options with 13-15 weeks delivery time, see page 163 | Scan the QR code to see additional features at our website



# Splitback Eik Smoked Oak

Design by Per Weiss, Oliver & Lukas WeissKrogh 2004, 2015

Bed size 115 x 210 cm | Chair size 115 x 90 cm | Metal frame with Pocket Spring comfort, see page 156 | Legs shown in smoked oak | Shown in 507 Elegance Burned Curry | Shown fabrics: 2-4 weeks delivery time | Other fabric options with 13-15 weeks delivery time, see page 163 | Scan the QR code to see additional features at our website

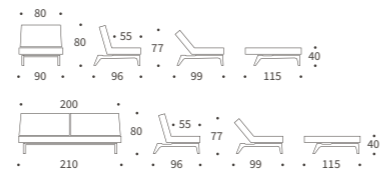
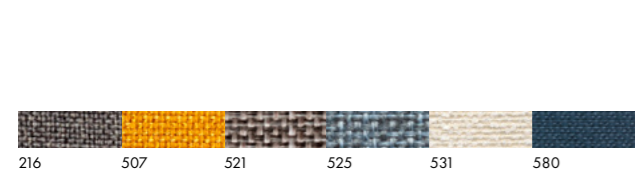

# Dublexo Eik Oak

Design by Per Weiss, Oliver & Lukas WeissKrogh 2011, 2015

Bed size 115 x 210 cm | Chair size 115 x 90 cm | Metal frame with Pocket Spring Dual comfort, see page 156 | Legs shown in lacquered oak | Shown in 558 Soft Indigo | Shown fabrics: 2-4 weeks delivery time | Other fabric options with 13-15 weeks delivery time, see page 163 | Scan the QR code to see additional features at our website

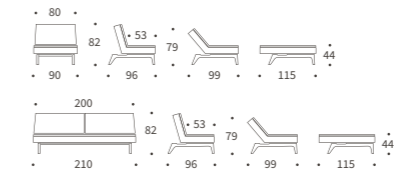
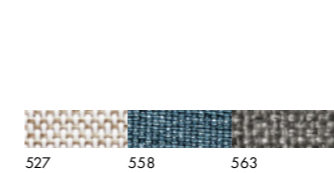

# Splitback Stem

Design by Per Weiss 2004, 2015

Bed size 115 x 210 cm | Chair size 115 x 90 cm | Metal frame with Pocket Spring comfort, see page 156 | Legs in lacquered oak | Shown in 525 Mixed Dance Light Blue | Shown fabrics: 2-4 weeks delivery time | Other fabric options with 13-15 weeks delivery time, see page 163 | Scan the QR code to see additional features at our website

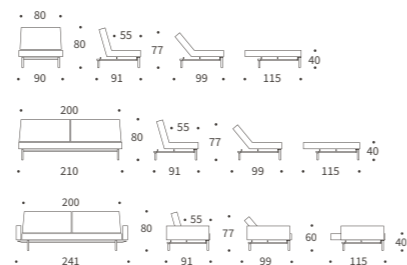

# Dublexo Stem

Design by Per Weiss 2011

Bed size 115 x 210 cm | Chair size 115 x 90 cm | Metal frame with Pocket Spring Dual comfort, see page 156 | Legs in lacquered oak | Shown in 527 Mixed Dance Natural | Shown fabrics: 2-4 weeks delivery time | Other fabric options with 13-15 weeks delivery time, see page 163 | Scan the QR code to see additional features at our website

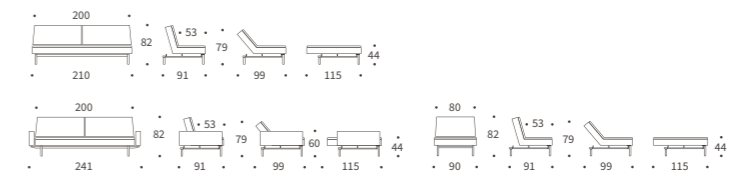

# Cubed Wood

Design by Per Weiss, Oliver & Lukas WeissKrogh 2009, 2015

Bed sizes 90 x 200 cm, 140 x 200 cm and 160 x 200 cm | No-zag Spring with high resilient foam comfort, see page 156 | Legs in lacquered oak | Optional headrest | Shown in size 140 cm in 565 Twist Granite | Shown fabrics: 2-4 weeks delivery time | Other fabric options with 6-8 weeks delivery time, see page 163 | Scan the QR code to see additional features at our website

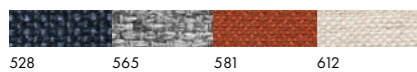

# Nolis

Design by Oliver & Lukas WeissKrogh 2022

Bed size 90 x 200 cm | Metal frame with Pocket Spring comfort, see page 156 | Legs in lacquered oak | Shown in 539 Bouclé Beige | Shown fabric: 2-4 weeks delivery time | Other fabric options with 13-15 weeks delivery time, see page 163 | Scan the QR code to see additional features at our website



539

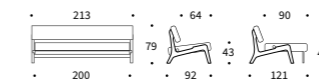

# Malloy Wood

Design by Per Weiss, Oliver & Lukas WeissKrogh 2020, 2021

Bed size 150 x 200 cm | Ottoman size 75 x 100 cm | Metal frame with Pocket Spring Dual comfort, see page 156 | Arms and legs in lacquered oak | Bedding box | Shown in 533 Bouclé Ash Grey | Shown fabrics: 2-4 weeks delivery time | Other fabric options with 13-15 weeks delivery time, see page 163 | Scan the QR code to see additional features at our website

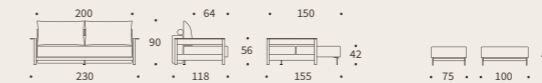



# Eluma Deluxe Button

Design by Per Weiss, Oliver & Lukas WeissKrogh 2016

Bed size 140 x 200 cm | Metal frame with Pocket Spring comfort, see page 156 | Arms and legs in lacquered oak | Bedding box | Optional headrest | Shown in 565 Twist Granite | Shown fabric: 2-4 weeks delivery time | Other fabric options with 13-15 weeks delivery time, see page 163 | Scan the QR code to see additional features at our website



565





# Balder

Design by Per Weiss, Oliver & Lukas WeissKrogh 2015

Bed size 140 x 200 cm | Metal frame with beech wood slats | Soft Spring comfort with detachable Nordic cover, see page 160 | Arms and legs in lacquered oak | Back frame cover included | Optional seat frame cover | Bedding box | Detachable and washable covers | Shown in 539 Bouclé Beige | 2-4 weeks delivery time | See all fabric options, page 163 | Scan the QR code to see additional features at our website

Balder is part of the Multifunctionals assortment and has several options of mattress comfort and cover styles, see page 160-161



# Rollo

Design by Flemming Højfeldt & Per Weiss 1993

Bed size 80 x 200 cm | Metal frame with Classic or Pocket Spring comfort, see page 160 | See leg options below | Detachable mattress and washable frame covers | Optional: Detachable mattress cover, frame cover and cushions | Shown in lacquered oak | Shown in 537 Bouclé Blue | 2-4 weeks delivery time | See all fabric options, page 163 | Available in all fabrics, see page 163 | Scan the QR code to see additional features at our website

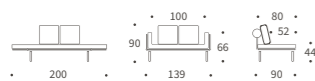

Bow legs in lacquered oak



Stem legs in lacquered oak



Stiletto legs in dark lacquered oak



# Ghia Wood

Design by Per Weiss 2007, 2015

Bed size 80 x 210 cm | Metal frame with Pocket Spring comfort, see page 156 | Legs in lacquered oak | Shown in 318 Cordufine Beige | Shown fabrics: 2-4 weeks delivery time | Other fabric options with 13-15 weeks delivery time, see page 163 | Scan the QR code to see additional features at our website

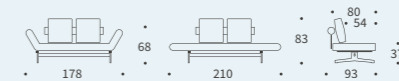

# Minimalist multifunctional daybed and playground



## Sigmund Drip

Design by Per Weiss 2016

Bed sizes 80 / 160 x 200 cm | Pocket Spring comfort, see page 157 | Drip legs in lacquered oak | Shown in 579 Kenya Gravel | Shown fabrics: 2-4 weeks delivery time | Other fabric options with 6-8 weeks delivery time, see page 163 | Scan the QR code to see additional features at our website

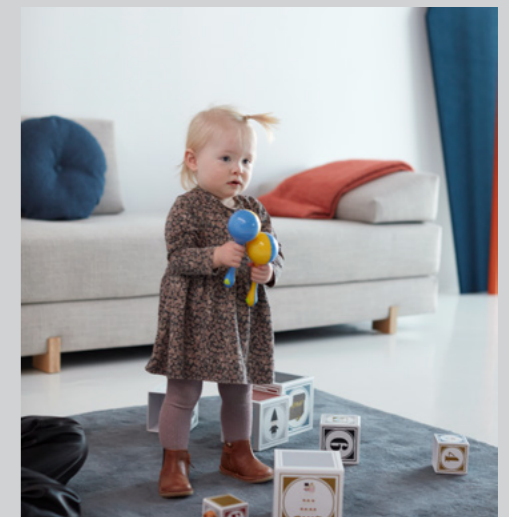

# Pyxis D.E.L.

Design by Per Weiss 2008, 2021

Bed size 155 x 200 cm | Ottoman size 65 x 65 cm | Metal frame with Excess Pocket Spring comfort, see page 156 | Legs in lacquered oak | Optional headrest | Shown in 587 Phobos Mocha | Shown fabrics: 2-4 weeks delivery time | Other fabric options with 13-15 weeks delivery time, see page 163 | Scan the QR code to see additional features at our website

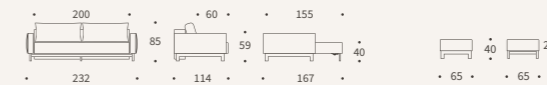
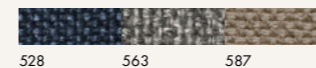



# Aslak

Design by Per Weiss, Oliver & Lukas WeissKrogh 2014

Bed sizes 120 x 200 cm and 140 x 200 cm | Metal frame with beech wood slats | Nordic mattress with Soft Spring comfort, see page 160 | Legs in lacquered oak | Back frame cover included | Optional seat frame cover | Bedding box | Detachable and washable frame covers | Page 74: Shown in size 140 cm in 535 Bouclé Forest Green | Page 75: Shown in size 120 cm in 507 Elegance Burned Curry | 2-4 weeks delivery time | See all fabric options, page 163 | Scan the QR code to see additional features at our website

Aslak is part of the Multifunctionals assortment and has several options of mattress comfort and cover styles, see page 160-161



# Sly Wood

Design by Per Weiss 2006, 2021

Bed size 140 x 200 cm | Metal frame with Pocket Spring comfort, see page 156 | Legs in lacquered oak | Bedding box | Optional headrest | Shown in 527 Mixed Dance Natural | Shown fabrics: 2-4 weeks delivery time | Other fabric options with 13-15 weeks delivery time, see page 163 | Scan the QR code and see further features at our website

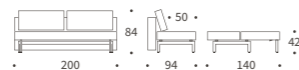

# Trym

Design by Per Weiss 2014

Bed size 140 x 200 cm | Metal frame with Pocket Spring comfort, see page 156 | Legs in lacquered oak | Detachable and washable covers | Bedding box | Optional headrest | Shown in 521 Mixed Dance Grey | Shown fabrics: 2-4 weeks delivery time | Other fabric options with 13-15 weeks delivery time, see page 163 | Scan the QR code to see additional features at our website

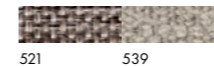



# Idun

Design by Per Weiss 2014

Bed size 140 x 200 cm | Metal frame with Pocket Spring comfort, see page 156 | Legs in lacquered oak | Detachable and washable covers | Bedding box | Optional headrest | Shown in 539 Bouclé Beige | Shown fabrics: 2-4 weeks delivery time | Other fabric options with 13-15 weeks delivery time, see page 163 | Scan the QR code to see additional features at our website

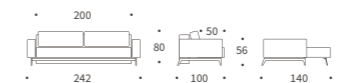





# Mimer

Design by Per Weiss 2016

Bed size 140 x 200 cm | Metal frame with beech wood slats | Nordic mattress with Spring comfort, see page 160 | Legs in lacquered oak | Back frame cover included | Optional seat frame cover | Bedding box | Detachable and washable mattress cover and frame covers | Shown in 536 Bouclé Ochre | 2-4 weeks delivery time | See all fabric options, page 163 | Scan the QR code to see additional features at our website

Mimer is part of the Multifunctionals assortment and has several options of mattress comfort and cover styles, see page 160-161





# Frode & Frode with arms

Design by Per Weiss 2018

Bed size 140 x 200 cm | Metal frame with Pocket Spring Dual comfort, see page 156 | Stem legs in lacquered oak | Optional arms | Optional headrest | Bedding box | Shown combination: Page 82: Frode with arms in fabric 531 Bouclé Off White | Shown combination: Page 32: Frode in fabric 573 Vivus Dusty Blue | Shown fabrics: 2-4 weeks delivery time | Other fabric options with 13-15 weeks delivery time, see page 163 | Scan the QR code to see additional features at our website

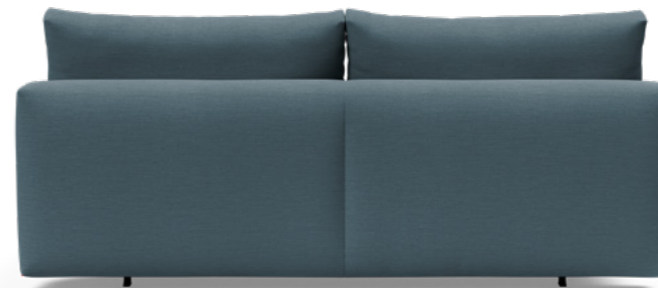

## European Modernism

A selection of designs inspired by the revolutionary Bauhaus school's thoughts on how to create modern, functional quality furniture optimized for industrial production. The modernist furniture movement was largely driven by the enthusiasm for industrial processing of metal, and our range pays homage to this with signature metal legs.



# Splitback Chrome with arms

Design by Per Weiss 2004

Bed size 115 x 210 cm | Chair size 115 x 90 cm | Metal frame with Pocket Spring comfort, see page 156 | Legs in chromed steel | Shown in 580 Argus Navy Blue | Shown fabrics: 2-4 weeks delivery time | Other fabric options with 13-15 weeks delivery time, see page 163 | Scan the QR code to see additional features at our website

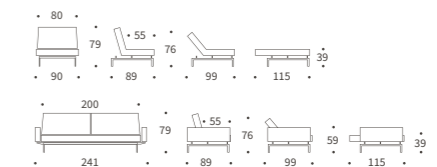



# Cubed Alu

Design by Per Weiss, Oliver & Lukas WeissKrogh 2009, 2019

Bed sizes 90 x 200 cm, 140 x 200 cm and 160 x 200 cm | No-zag Spring with high resilient foam comfort, see page 156 | Legs in aluminium | Optional headrest | Shown in 140 cm in 528 Mixed Dance Blue | Shown fabrics: 2-4 weeks delivery time | Other fabric options with 6-8 weeks delivery time, see page 163 | Scan the QR code to see additional features at our website

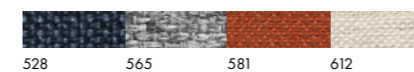
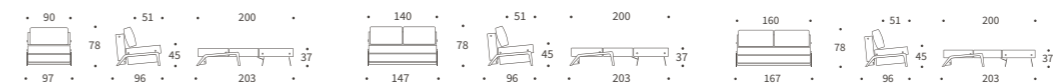

# Cubed Chrome

Design by Per Weiss 2009

Bed sizes 90 x 200 cm, 140 x 200 cm and 160 x 200 cm | No-zag Spring with high resilient foam comfort, see page 156 | Legs in chromed steel | Optional headrest | Shown in 90 cm in 581 Argus Rust | Shown fabrics: 2-4 weeks delivery time | Other fabric options with 6-8 weeks delivery time, see page 163 | Scan the QR code to see additional features at our website

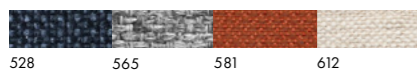

# Cubed with arms

Design by Per Weiss 2009, 2015

Bed sizes 90 x 200 cm, 140 x 200 cm and 160 x 200 cm | No-zag Spring with high resilient foam comfort, see page 156 | Legs in matt black steel | Optional headrest | Shown in 160 cm in 612 Blida Sand Grey | Shown fabrics: 2-4 weeks delivery time | Other fabric options with 6-8 weeks delivery time, see page 163 | Scan the QR code to see additional features at our website

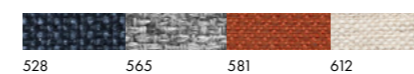
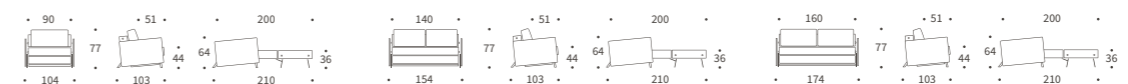

# Zeal Straw

Design by Per Weiss 2013

Bed size 70 x 200 cm | Metal frame with Pocket Spring comfort, see page 156 | Legs in aluminium | Shown in 581 Argus Rust | Shown fabrics: 2-4 weeks delivery time | Other fabric options with 13-15 weeks delivery time, see page 163 | Scan the QR code to see additional features at our website

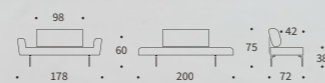
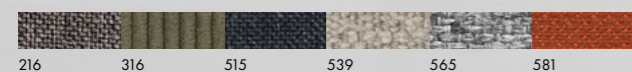

# Zeal Laser

Design by Per Weiss 2013

Bed size 70 x 200 cm | Metal frame with Pocket Spring comfort, see page 156 | Legs in matt black steel | Shown in 316 Cordufine Pine Green | Shown fabrics: 2-4 weeks delivery time | Other fabric options with 13-15 weeks delivery time, see page 163 | Scan the QR code to see additional features at our website

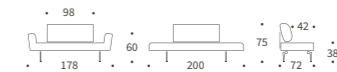



# Ghia Chrome

Design by Per Weiss 2007

Bed size 80 x 210 cm | Metal frame with Pocket Spring comfort, see page 156 | Chrome legs in chromed steel | Shown in 551 Faunal Brown | Shown fabrics: 2-4 weeks delivery time | Other fabric options with 13-15 weeks delivery time, see page 163 | Scan the QR code to see additional features at our website

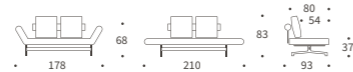

# Ghia Laser

Design by Per Weiss 2007, 2016

Bed size 80 x 210 cm | Metal frame with Pocket Spring comfort, see page 156 | Laser legs matt black steel | Shown in 318 Cordufine Beige with Laser legs | Shown fabrics: 2-4 weeks delivery time | Other fabric options with 13-15 weeks delivery time, see page 163 | Scan the QR code to see additional features at our website

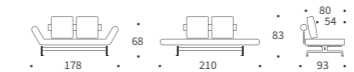



# Supremax D.E.L.

Design by Per Weiss 2008

Bed size 155 x 200 cm | Ottoman size 65 x 65 cm | Metal frame with Excess Pocket Spring comfort, see page 156 | Legs in chromed steel | Optional headrest | Page 98: Shown in 528 Mixed Dance Blue | Page 99: Shown in 563 Twist Charcoal | Shown fabrics: 2-4 weeks delivery time | Other fabric options with 13-15 weeks delivery time, see page 163 | Scan the QR code to see additional features at our website

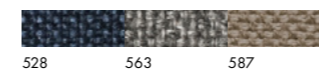



# Cassius D.E.L.

Design by Per Weiss 2008

Bed size 155 x 200 cm | Ottoman size 65 x 65 cm | Metal frame with Excess Pocket Spring comfort, see page 156 | Legs in chromed steel | Optional headrest | Page 100: Shown in 528 Mixed Dance Blue | Page 101: Shown in 587 Phobos Mocha | Shown fabrics: 2-4 weeks delivery time | Other fabric options with 13-15 weeks delivery time, see page 163 | Scan the QR code to see additional features at our website

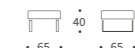
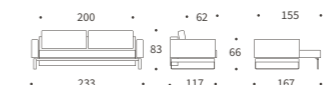
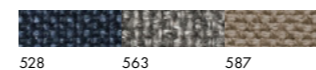



# Minimum

Design by Peter Henriksen & Per Weiss 2003

Bed size 140 x 200 cm | Metal frame with beech wood slats | Classic comfort with Nordic Mattress, see page 160 | Legs in chromed steel | Back frame cover included | Optional seat frame cover | Bedding box | Detachable and washable covers | Shown in 529 Bouclé Charcoal | 2-4 weeks delivery time | See all fabric options, page 163 | Scan the QR code to see additional features at our website

Minimum is part of the Multifunctionals assortment and has several options of mattress comfort and cover styles, see page 160-161





# Nordham

Design by Per Weiss 2020

Bed size 140 x 200 cm | Metal frame with Pocket Spring comfort, see page 156 | Legs in brushed stainless steel | Bedding box | Optional headrest | Page 104: Shown in 528 Mixed Dance Blue | Page 105: Shown in 590 Micro Check Grey | Shown fabrics: 2-4 weeks delivery time | Other fabric options with 13-15 weeks delivery time, see page 163 | Scan the QR code to see additional features at our website

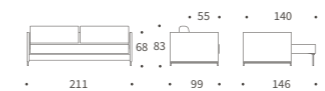
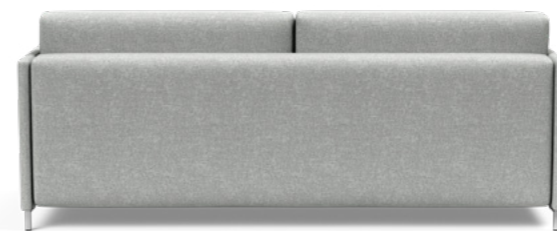



# Long Horn D.E.L.

Design by Per Weiss, Oliver & Lukas WeissKrogh 2008, 2015

Bed size 140 x 210 cm | Chair size 115 x 85 cm | Metal frame with Excess Pocket Spring comfort, see page 156 | Legs in stainless steel and arms in walnut veneer | Optional arms | Shown in 565 Twist Granite | Shown fabric: 2-4 weeks delivery time | Other fabric options with 13-15 weeks delivery time, see page 163 | Scan the QR code to see additional features at our website

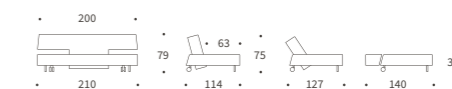
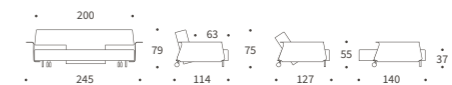



# Luoma

Design by Per Weiss 2022

Bed size 140 x 200 cm | No-zag Spring with high resilient foam comfort, see page 156 | Legs in matt black steel | Optional headrest | Page 108: Shown in 300 Weda Sand | Page 109: Shown in 302 Weda Blue | Shown fabrics: 2-4 weeks delivery time | Other fabric options with 13-15 weeks delivery time, see page 163 | Scan the QR code to see additional features at our website

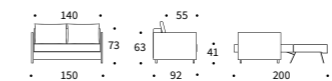



# Malloy

Design by Per Weiss 2020

Bed size 150 x 200 cm | Ottoman size 75 x 100 cm | Metal frame with Pocket Spring Dual comfort, see page 156 | Legs in matt black steel | Bedding box | Shown in 579 Kenya Gravel | Shown fabrics: 2-4 weeks delivery time | Other fabric options with 13-15 weeks delivery time, see page 163 | Scan the QR code to see additional features at our website

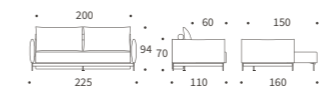



# Junus

Design by Per Weiss 2021

Bed size 140 x 200 cm | Metal frame with beech wood slats | Spring comfort with detachable Sharp cover, see page 160 | Legs in matt black steel | Back frame cover included | Optional seat frame cover | Bedding box | Detachable and washable mattress cover and frame covers | Shown in 301 Weda Rust | 2-4 weeks delivery time | See all fabric options, page 163 | Scan the QR code to see additional features at our website

Junus is part of the Multifunctionals assortment and has several options of mattress comfort and cover styles, see page 160-161

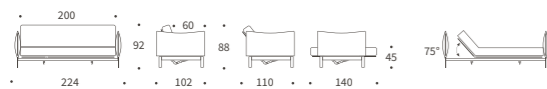



# Sigmund Indu

Design by Per Weiss 2016

Bed sizes 80 / 160 x 200 cm | Pocket Spring comfort, see page 157 | Indu legs in matt black steel |  
Page 114: Shown in 595 Corduroy Burnt Orange | Page 115: Shown in 537 Bouclé Blue | Shown  
fabrics: 2-4 weeks delivery time | Other fabric options with 6-8 weeks delivery time, see page 163 |  
Scan the QR code to see additional features at our website

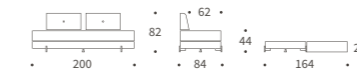
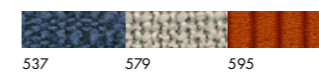



# Bragi

Design by Emil Højfeldt & Per Weiss 2015

Bed size 140 x 200 cm | Metal frame with Pocket Spring comfort, see page 156 | Legs in matt black steel | Reversible lounger | Available with side table or upholstered arms | Optional headrest | Shown in 217 Flashtex Light Grey | Shown fabric: 2-4 weeks delivery time | Other fabric options with 13-15 weeks delivery time, see page 163 | Scan the QR code to see additional features at our website

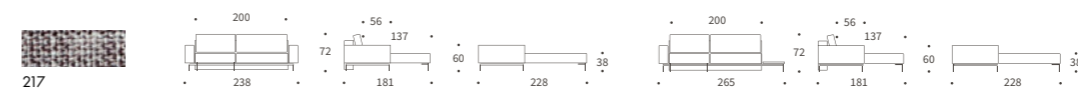



# Sly

Design by Per Weiss 2006

Bed size 140 x 200 cm | Metal frame with Pocket Spring comfort, see page 156 | Legs in matt black steel | Bedding box | Optional headrest | Shown in 563 Twist Charcoal | Shown fabrics: 2-4 weeks delivery time | Other fabric options with 13-15 weeks delivery time, see page 163 | Scan the QR code to see additional features at our website

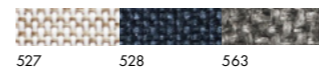



# Fraction

Design by Per Weiss 2008

Bed sizes 120 x 200 cm and 140 x 200 cm | Metal frame with beech wood slats | Nordic mattress with Soft Spring comfort, see page 160 | Legs in matt black steel | Back frame cover included | Optional seat frame cover | Bedding box | Detachable and washable frame covers | Shown in size 120 cm in 537 Bouclé Blue | 2-4 weeks delivery time | See all fabric options, page 163 | Scan the QR code to see additional features at our website

Fraction is part of the Multifunctionals assortment and has several options of mattress comfort and cover styles, see page 160-161





# Narvi

Design by Per Weiss 2018

Bed size 140 x 200 cm | Metal frame with Pocket Spring comfort, see page 156 | Arms in cane web black lacquered oak | Detachable and washable covers | Bedding box | Optional headrest | Shown in 539 Bouclé Beige | Shown fabrics: 2-4 weeks delivery time | Other fabric options with 13-15 weeks delivery time, see page 163 | Scan the QR code to see additional features at our website

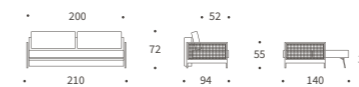
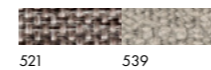



# Bifrost D.E.L.

Design by Per Weiss 2008

Bed size 155 x 200 cm | Ottoman size 65 x 65 cm | Metal frame with Excess Pocket Spring comfort, see page 156 | Arms and legs in black stained wood | Optional headrest | Shown in 587 Phobos Mocha | Shown fabrics: 2-4 weeks delivery time | Other fabric options with 13-15 weeks delivery time, see page 163 | Scan the QR code to see additional features at our website

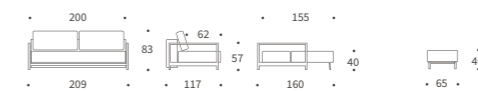
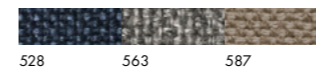

## Mid-Century Modern

A selection of designs with reference to international Mid-Century Modern. The archetypal styletto leg has become the signature element of the assortment.





# Unfurl Lounger

Design by Andreas Lund, Flemming Højfeldt & Per Weiss 2017

Bed size 140 x 200 cm | Metal frame with Pocket Spring comfort, see page 156 | Styletto legs in dark lacquered oak | Shown in 594 Corduroy Ivory | Shown fabrics: 2-4 weeks delivery time | Other fabric options with 13-15 weeks delivery time, see page 163 | Scan the QR code to see additional features at our website

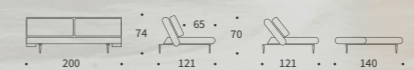
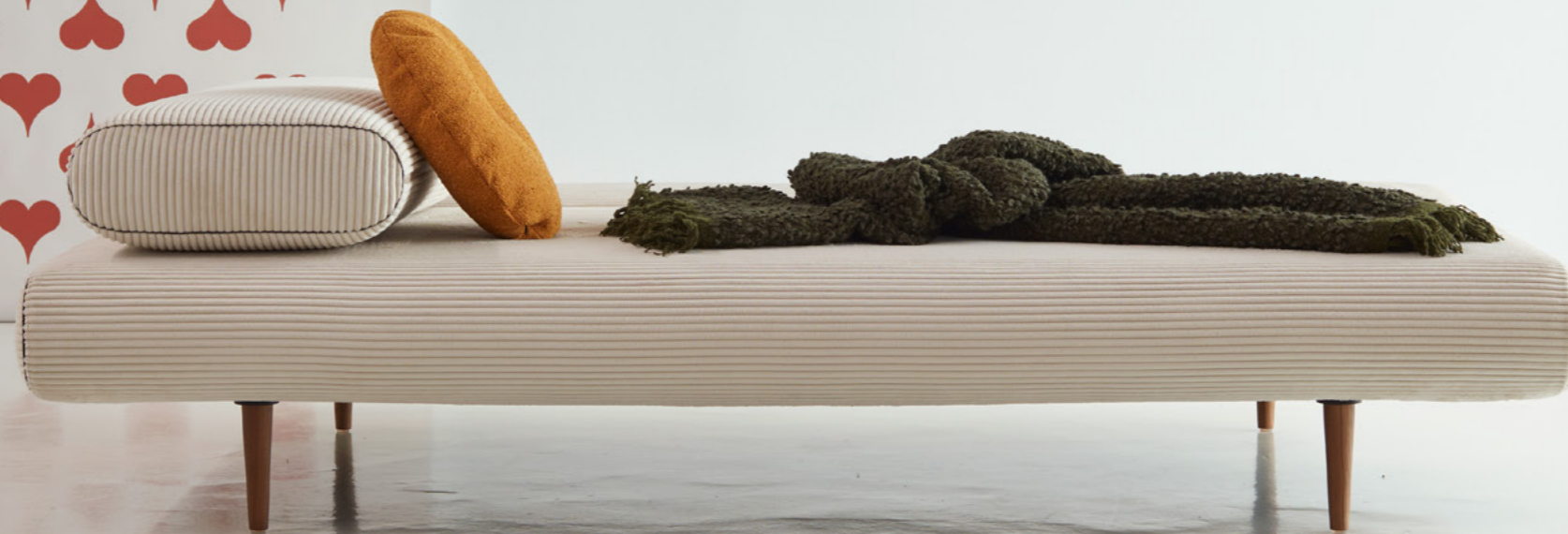



# Unfurl

Design by Andreas Lund, Flemming Højfeldt & Per Weiss 2004

Bed size 120 x 200 cm | Metal frame with Pocket Spring comfort, see page 156 | Styletto legs in dark lacquered oak | Page 130: Shown in 536 Bouclé Ochre | Page 131: Shown in 529 Bouclé Charcoal | Shown fabrics: 2-4 weeks delivery time | Other fabric options with 13-15 weeks delivery time, see page 163 | Scan the QR code to see additional features at our website



# Splitback Dark Styletto with arms

Design by Per Weiss 2004, 2014

Bed size 115 x 210 cm | Chair size 115 x 90 cm | Metal frame with Pocket Spring comfort, see page 156 | Legs shown in dark lacquered oak | Shown with Sharp arms in 507 Elegance Burned Curry | Shown fabrics: 2-4 weeks delivery time | Other fabric options with 13-15 weeks delivery time, see page 163 | Scan the QR code to see additional features at our website

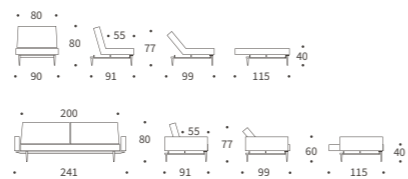
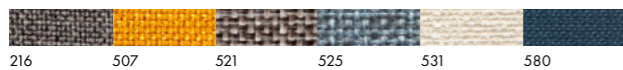

# Dublexo Dark Styletto with arms

Design by Per Weiss 2011

Bed size 115 x 210 cm | Chair size 115 x 90 cm | Metal frame with Pocket Spring Dual comfort, see page 156 | Legs shown in dark lacquered oak | Shown with Round arms in 527 Mixed Dance Natural | Shown fabrics: 2-4 weeks delivery time | Other fabric options with 13-15 weeks delivery time, see page 163 | Scan the QR code to see additional features at our website

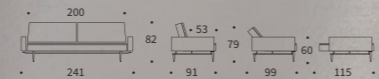
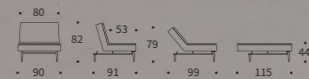

# Zeal Styletto

Design by Per Weiss 2013

Bed size 70 x 200 cm | Metal frame with Pocket Spring comfort, see page 156 | Styletto legs in dark lacquered oak | Shown in 539 Bouclé Beige | Shown fabrics: 2-4 weeks delivery time | Other fabric options with 13-15 weeks delivery time, see page 163 | Scan the QR code to see additional features at our website

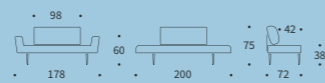



# Recast Dark Styletto

Design by Per Weiss 2011, 2015

Bed size 140 x 200 cm | Ottoman size 66 x 66 cm | Metal frame with Pocket Spring comfort, see page 156 | Styletto legs in dark lacquered oak | Optional arms in walnut veneer | Bedding box | Optional headrest | Shown in 536 Bouclé Ochre | Shown fabrics: 2-4 weeks delivery time | Other fabric options with 13-15 weeks delivery time, see page 163 | Scan the QR code to see additional features at our website

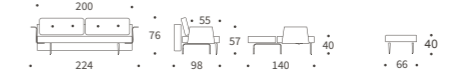
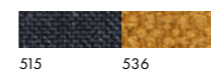



# Recast Light Styletto

Design by Per Weiss 2011, 2015

Bed size 140 x 200 cm | Ottoman size 66 x 66 cm | Metal frame with Pocket Spring comfort, see page 156 | Styletto legs in lacquered oak | Bedding box | Optional headrest | Shown in 590 Micro Check Grey | Shown fabric: 2-4 weeks delivery time | Other fabric options with 13-15 weeks delivery time, see page 163 | Scan the QR code to see additional features at our website



590



# Conlix

Design by Per Weiss 2020

Bed size 140 x 200 cm | Metal frame with Pocket Spring comfort, see page 156 | Trumpet legs in lacquered oak | Detachable and washable cover | Bedding box | Optional headrest | Shown in 531 Bouclé Off White | Shown fabrics: 2-4 weeks delivery time | Other fabric options with 13-15 weeks delivery time, see page 163 | Scan the QR code and see further features at our website





# Vanadis

Design by Per Weiss 2018

Bed size 80 x 200 cm | Frame in lacquered oak with Bonell Spring comfort, see Page 157 | Storage | Legs in lacquered oak | Optional metal back support | Shown in 563 Twist Charcoal | Shown fabric: 2-4 weeks delivery time | Other fabric options with 6-8 weeks delivery time, see page 163 | Scan the QR code to see additional features at our website

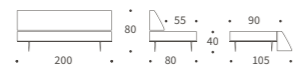
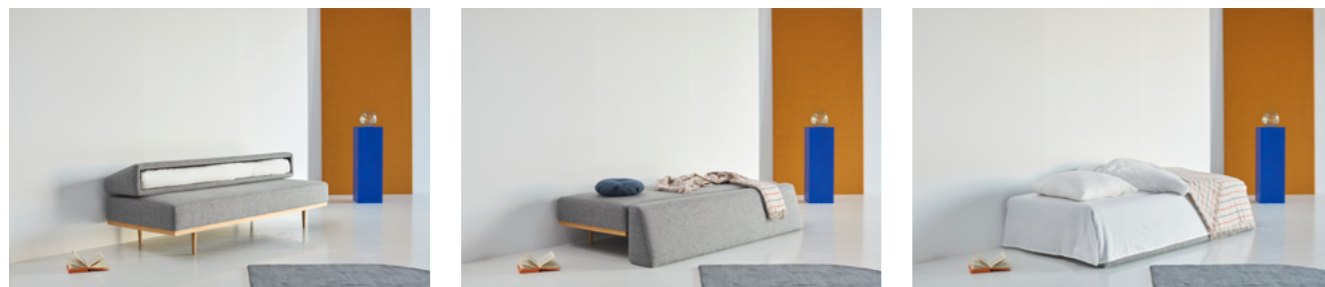



# Colpus

Design by Per Weiss 2014

Bed size 140 x 200 cm | Metal frame with beech wood slats | Soft Spring comfort with Nordic mattress, see page 160 | Legs in lacquered or black lacquered oak | Back frame cover included | Optional seat frame cover | Bedding box | Detachable and washable frame covers | Shown in 531 Bouclé Off White with legs in lacquered oak | 2-4 weeks delivery time | See all fabric options, page 163 | Scan the QR code to see additional features at our website

Colpus is part of the Multifunctionals assortment and has several options of mattress comfort and cover styles, see page 160-161



Also available with black lacquered oak legs



# There is an intention behind every design

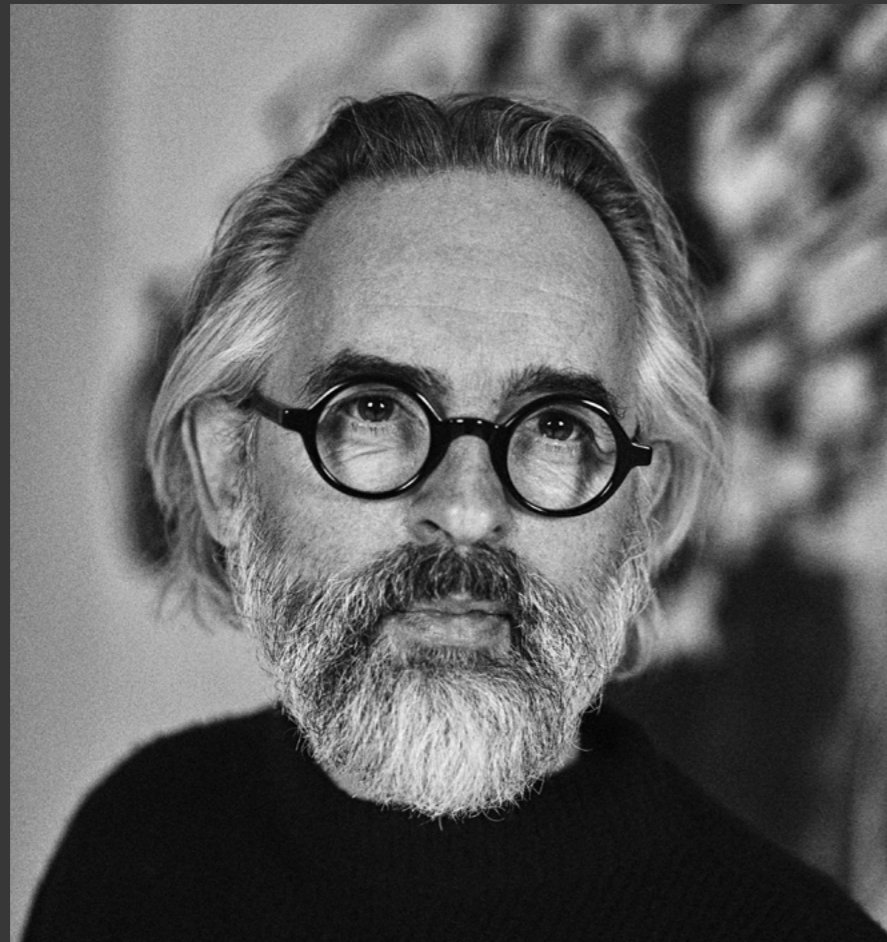

## Per Weiss

Chief Design Officer  
Innovation Living Design Office

The Danish designer Per Weiss is the Chief Design Officer at Innovation Living. He has been part of Innovation Living since 1989 and is the driving force behind the constant creative development of the collections.

Based on the Scandinavian design tradition, Per is constantly striving to create durable designs that reflect zeitgeist - attractive designs that will make a positive difference in everyday life.



01



02



03



04



05

- 01. Emil Højfeldt, Product- & Production Development Manager
- 02. Oliver & Lukas WeissKrogh, Studio WeissKrogh
- 03. Flemming Højfeldt, Founder of Innovation Living™
- 04. Jesper Elg, Owner of v1 Gallery Copenhagen
- 05. Andreas Lund, Industrial Designer
- 06. Peter Henriksen, Industrial Designer



06



**Vikko Chair & Vikko Chair with arms**

Design by Emil Højfeldt & Per Weiss 2018, 2020

Size: 68 x 62 cm | Seat Height: 37 cm | Legs in matt black steel | Page 150 shown with arms in 537 Bouclé Blue | Page 151 shown in 535 Bouclé Forest Green | Shown fabrics: 2-4 weeks delivery time | Other fabric options with 6-8 weeks delivery time, see page 163

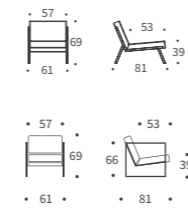

**Soft Peak Bean Bag**

Design by Innovation Living Design Office 2015

Size: 105-135-80 cm | Detachable and washable cover | Volume: Inside 300 litres EPS Beads | Shown in 594 Corduroy Ivory | 2-4 weeks delivery time | The detachable cover makes it possible to renew the bean bag. Can also be refilled. | See all fabric options, page 163

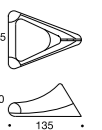



**Butt Bean Bag**

Design by Jesper Elg 2002

Size: 45 x H50 cm | Detachable and washable cover | Volume: Inside 100 litres EPS Beads | Shown in 536 Bouclé Ochre | 2-4 weeks delivery time | The detachable cover makes it possible to renew the bean bag. Can also be refilled | See all fabric options, page 163

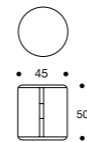

**Pauke Poufs 50 & 62 cm**

Design by Innovation Living Design Office

Sizes: Ø50 x 20 cm and Ø62 x 40 cm | Recycled foam | Detachable and washable cover | Shown in 536 Bouclé Ochre, 537 Bouclé Blue and 535 Bouclé Forest Green | Shown fabrics: 2-4 weeks delivery time | Other fabric options with 4-6 weeks delivery time, see page 163

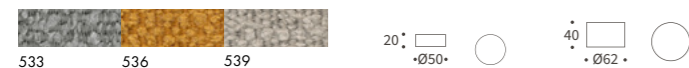

**Triangular Pouf**

Design by Innovation Living Design Office

Size: W 60 x H 37 cm | Recycled foam | Detachable and washable cover | Shown in 536 Bouclé Ochre | Shown fabrics: 2-4 weeks delivery time | Other fabric options with 6-8 weeks delivery time, see page 163

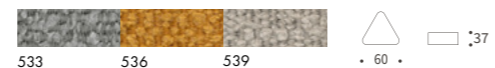

**Dapper Cushions**

Sizes: 50 x 50 cm, 65 x 65 cm, 40 x 60 cm and 50 x 80 cm | Detachable and washable cover | Feather mix inside | The detachable cover makes it possible to renew the cushion | See all fabric options, page 163

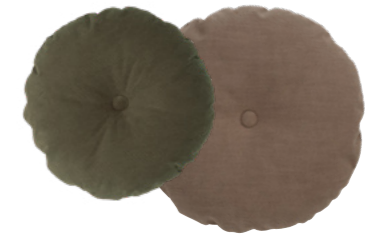

**Circle Cushions**

Sizes: Ø 40 cm and Ø 45 cm | Button on both sides | Polyester fill inside | See all fabric options, page 163



**Ellipse Cushions**

Size: 55 x 25 x 13 cm | Detachable and washable cover | Feather mix inside | The detachable cover makes it possible to renew the cushion | See all fabric options, page 163



**Roll Cushions**

Size: 55 x Ø 25 cm | Detachable and washable cover | Feather mix inside | The detachable cover makes it possible to renew the cushion | See all fabric options, page 163



**Square Cushions**

Size: 50 x 50 x 11 cm | Detachable and washable cover | Feather mix inside | The detachable cover makes it possible to renew the cushion | Recommended for Rollo daybed | See all fabric options, page 163

**Headrest**

Size: 25 x 60 cm | Detachable and washable cover | Inside is a foam core surrounded by a layer of fiberfill | The detachable cover makes it possible to renew the headrest | See all fabric options, page 163

Adjustable headrest available for: Bifrost, Bragi, Cassius, Conlix, Cosial, Cubed, Eluma, Frode, Idun, Luoma, Merga, Narvi, Newilla, Newilla with lounger, Nordham, Osvald, Pyxis, Recast, Sly, Supremax, Tripi and Trym



**Nordic Tables**

Design by Emil Højfeldt & Per Weiss



Combine table tops with Nordic legs in lacquered oak, see options below.

**Small**  
Top in lacquered oak veneer  
Ø 35 cm | Legs 32,5 cm  
Top in black stained oak veneer  
Ø 35 cm | Legs 32,5 cm

**Medium**  
Top in lacquered oak veneer  
Ø 45 cm | Legs 32,5 cm  
Top in black stained oak veneer  
Ø 45 cm | Legs 32,5 cm

**Large**  
Top in lacquered oak veneer  
Ø 70 cm | Legs 40 cm  
Top in black stained oak veneer  
Ø 70 cm | Legs 40 cm

**Grids Tables**

Design by Per Weiss



Combine table tops with Grid legs in matt black steel, see options below.

**Small**  
Top in lacquered oak veneer  
Ø 35 cm | Legs 25 cm  
Top in black stained oak veneer  
Ø 35 cm | Legs 25 cm

**Medium**  
Top in lacquered oak veneer  
Ø 45 cm | Legs 32,5 cm  
Top in black stained oak veneer  
Ø 45 cm | Legs 32,5 cm

**Large**  
Top in lacquered oak veneer  
Ø 70 cm | Legs 40 cm  
Top in black stained oak veneer  
Ø 70 cm | Legs 40 cm

**Stylo Tables**

Design by Emil Højfeldt & Per Weiss



Combine black table tops with Stylo legs in dark lacquered oak, see options below.

**Small**  
Top in black stained oak veneer  
Ø 35 cm | Legs 32,5 cm

**Medium**  
Top in black stained oak veneer  
Ø 45 cm | Legs 32,5 cm

**Large**  
Top in black stained oak veneer  
Ø 70 cm | Legs 40 cm

**Marble Tables**

Design by Emil Højfeldt & Per Weiss



Combine Marble table tops with Laser legs in black steel, see options below.

**Small**  
Top in Ø 35 cm | Legs 32,5 cm

**Medium**  
Top in Ø 45 cm | Legs 32,5 cm

**Large**  
Top in Ø 70 cm | Legs 40 cm

**Laser Tables**

Design by Per Weiss



Combine table tops with Laser legs in black steel, see options below.

**Small**  
Top in lacquered oak veneer  
Ø 35 cm | Legs 32,5 cm  
Top in black stained oak veneer  
Ø 35 cm | Legs 32,5 cm

**Medium**  
Top in lacquered oak veneer  
Ø 45 cm | Legs 32,5 cm  
Top in black stained oak veneer  
Ø 45 cm | Legs 32,5 cm

**Large**  
Top in lacquered oak veneer  
Ø 70 cm | Legs 40 cm  
Top in black stained oak veneer  
Ø 70 cm | Legs 40 cm

**Kiffa Table**

Design by Emil Højfeldt 2017



The Kiffa table is a flexible and easily height adjustable table for any purpose.

Size Ø 45 cm | Height 41 - 70 cm | Table base: Matt black steel Top in Lacquered oak veneer or black stained oak veneer.

**Storage Table**

Design by Emil Højfeldt & Per Weiss 2016



Storage: 110 litres | Size: Ø 70 cm and H 43 cm | Table Top: 70 cm, black stained oak veneer or lacquered oak veneer | The table has a movable table top and a large storage compartment | Shown fabric: 2-4 weeks delivery time | Other fabric options with 4-6 weeks delivery time, see page 163

\*All table tops are available separately and can be used as a tray.

### Pocket Spring

The individual pockets in these models ensure that pressure is applied to each individual spring for optimal support – in seating as well as sleeping position. The high resilient foam casing contributes to a breathable mattress while providing a soft top support.

**The following models have this comfort:**

Bragi, Conlix, Cosial, Eluma Deluxe Button, Ghia, Idun, Narvi, Nolis, Nordham, Pascala, Recast, Sigga X, Splitback, Sly, Sly Wood, Trym, Unfurl, Unfurl Lounger and Zeal.

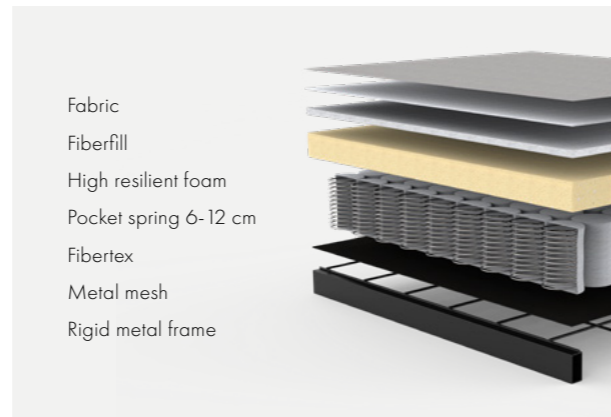

- Fabric
- Fiberfill
- High resilient foam
- Pocket spring 6-12 cm
- Fibertex
- Metal mesh
- Rigid metal frame

### Pocket Spring Dual

The Pocket Spring Dual comfort share the general composition of the Pocket Spring models apart from the extra layer of hyper soft foam that gives these sofa beds an extra soft feel. This extra layer of luxury provides a soft seating and sleeping comfort.

**The following models have this comfort:**

Cornila, Dublexo, Frode, Malloy, Malloy Wood, Osvald and Tripi.

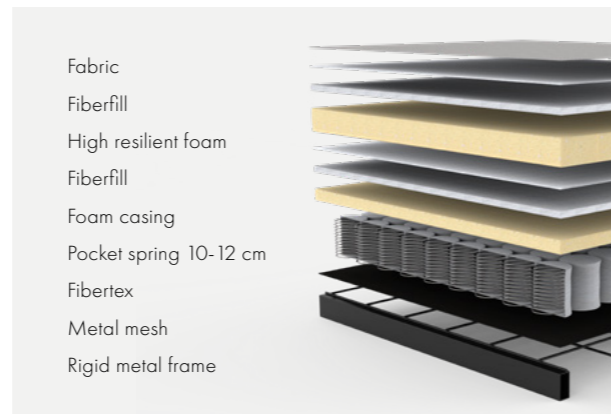

- Fabric
- Fiberfill
- High resilient foam
- Fiberfill
- Foam casing
- Pocket spring 10-12 cm
- Fibertex
- Metal mesh
- Rigid metal frame

### Excess Pocket Spring

The higher coils in the Excess Pocket Spring models provide a softer sofa comfort. In combination with the core foam casing, the Excess mattress has higher absorption of pressure on each spring for a more comfortable sleep.

**The following models have this comfort:**

Bifrost D.E.L., Cassius D.E.L., Long Horn D.E.L., Pyxis D.E.L., Supremax D.E.L., Vogan, Vogan Lounger and Yonata.

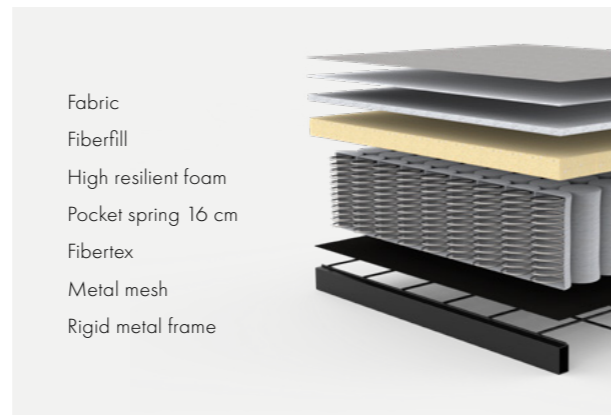

- Fabric
- Fiberfill
- High resilient foam
- Pocket spring 16 cm
- Fibertex
- Metal mesh
- Rigid metal frame

### No-zag Spring

The no-zag springs and the thick layer of high resilient foam provide an even and soft seating as well as sleeping experience.

**The following models have this comfort:**

Cubed, Luoma and Olan.

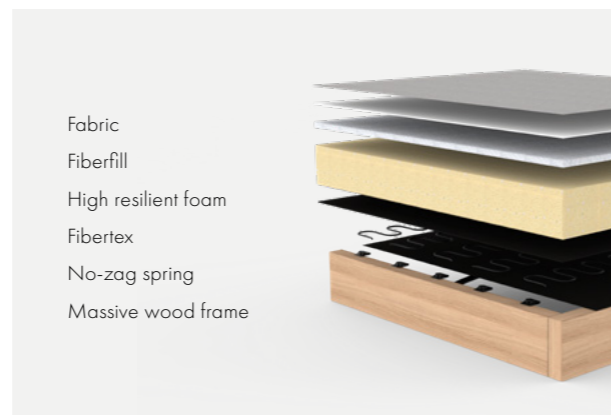

- Fabric
- Fiberfill
- High resilient foam
- Fibertex
- No-zag spring
- Massive wood frame

### No-zag and Pocket Spring

The combination of no-zag and pocket springs with a hyper soft foam on top create a unique softness in seating as well as sleeping position. The use of no-zag contributes to an extra layer of elasticity and allows the mattress to breathe.

**The following models have this comfort:**

Merga, Newilla and Newilla with lounger.

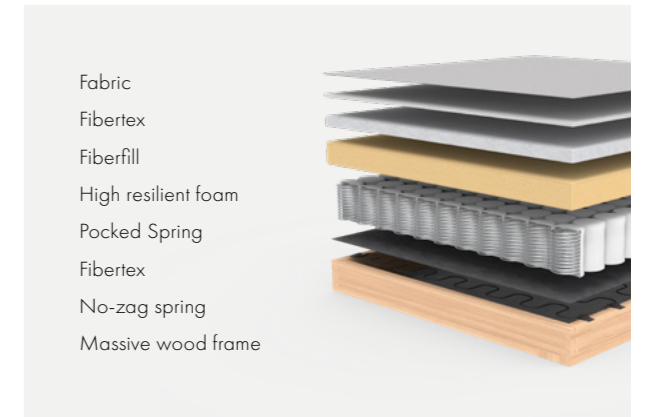

- Fabric
- Fibertex
- Fiberfill
- High resilient foam
- Pocked Spring
- Fibertex
- No-zag spring
- Massive wood frame

### Bonell Spring

The Bonell Spring mattress is characterised by the use of strong, connected springs topped with a layer of high resilient foam. This spring type distributes the pressure from your body on a larger area to create an even, yet elastic support.

**The following model has this comfort:**

Vanadis.

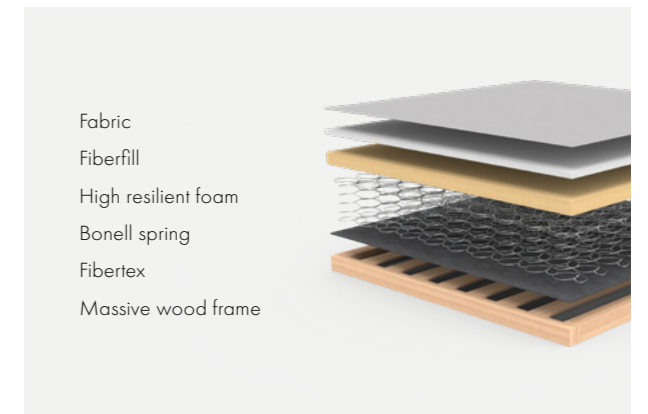

- Fabric
- Fiberfill
- High resilient foam
- Bonell spring
- Fibertex
- Massive wood frame

### Sigmund

Pocket Spring mattresses ensure that pressure is applied to each spring separately. The result is a mattress that supports individual parts of your body better. The springs are surrounded by layers of high resilient foam providing a soft top support – whether for playing, sitting, or sleeping. Pocket Split mattresses consist of two separate mattresses that can be used separate or in combination.

**The following model has this comfort:**

Sigmund.

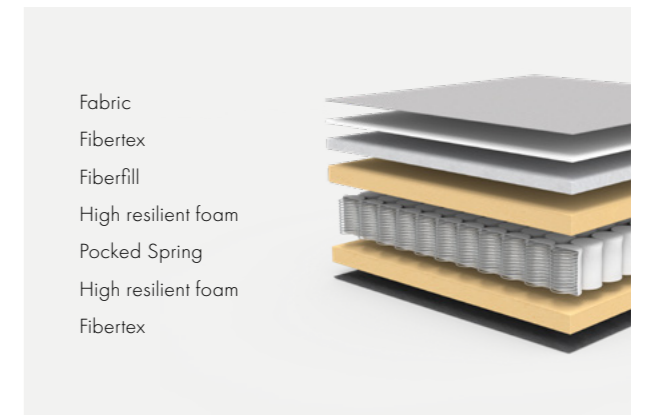

- Fabric
- Fibertex
- Fiberfill
- High resilient foam
- Pocked Spring
- High resilient foam
- Fibertex

### 5-zone Multi-Pocket Spring

The breathable Multi-Pocket Spring mattress - designed for comfortable sleep with as many as 650 springs per square meter and 5 comfort zones to support the individual parts of your body. Furthermore, the cover is removable and can be washed at 60 degrees Celsius.

**Available for:**  
Eivor and Killian.

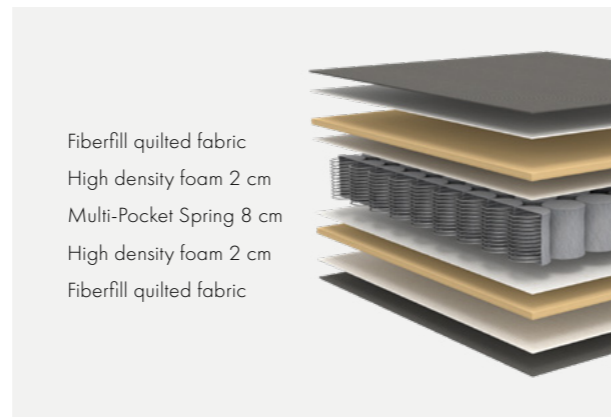

Fiberfill quilted fabric  
High density foam 2 cm  
Multi-Pocket Spring 8 cm  
High density foam 2 cm  
Fiberfill quilted fabric

### Dual Memory

The Dual Memory mattress features two comforts in one as the mattress is reversible with one side consisting of an 8 cm high density foam whilst the other side consists of 4 cm OEKO-TEX® certified memory foam. Whether you prefer soft or firm comfort this mattress offers both. Furthermore, the cover is removable and can be washed at 60 degrees Celsius.

**Available for:**  
Eivor and Killian.

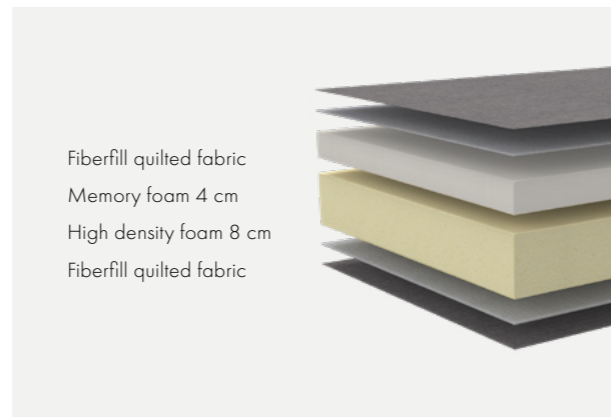

Fiberfill quilted fabric  
Memory foam 4 cm  
High density foam 8 cm  
Fiberfill quilted fabric

### Puri

A core of high resilient OEKO-TEX® foam surrounded by soft layers of fiberfill creates a firm mattress suitable for comfortable seating and sleeping.

**The following model has this comfort:**  
Puri.

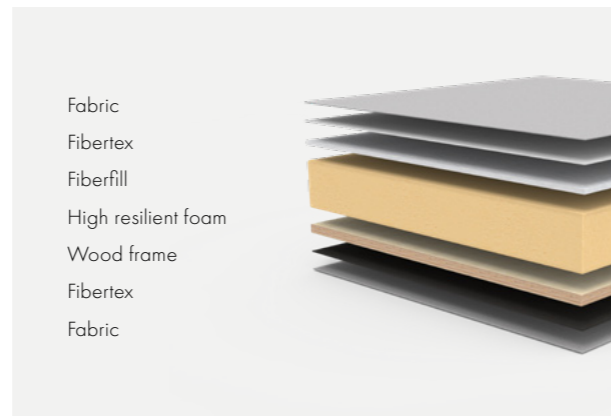

Fabric  
Fibertex  
Fiberfill  
High resilient foam  
Wood frame  
Fibertex  
Fabric

### Inno Toppers

80 / 90 / 120 / 140 / 150 / 160 / 180 x 200 cm.

A 5 cm durable and reversible top mattress with a core of hyper soft foam that provides an even and supportive sleeping surface on all adjustable sofa beds. The cover is 100% polyester which is breathable, removable and machine-washable at 60 degrees Celsius.

The top mattress comes with a bag for storage when not in use. The bag helps minimise the volume of the topper for better storage.



### Mattress Pads

80 / 90 / 120 / 140 / 150 / 160 x 200 cm.

A mattress pad provides a little extra cushioning and an added layer of protection for your mattress. They can be removed and machine-washed at 60 degree Celsius. The fabric is OEKO-TEX® standard 100 certified.

Available for most mattresses.



# Multifunctionals

## Customize your sofa

- 01 Choose frame
- 02 Select mattress type
- 03 Choose between fixed or removable cover
- 04 Select the styling of your cover
- 05 Select frame cover for the seat
- 06 Choose fabric

## The frames

- Aslak**, see page 74
- Balder**, see page 66
- Colpus**, see page 146
- Fraction**, see page 120
- Junus**, see page 112
- Mimer**, see page 80
- Minimum**, see page 102

## The mattresses:

### Classic

Firmness rating: Firm  
 Mattress sizes: 120 / 140 x 200 cm.  
 Made from recycled foam, the Classic mattress is durable and provides a high degree of support for a comfortable sleep. Our high density foam provides strong motion isolation, making it easy to share the mattress. Choose our Classic mattress for a firm comfort.



### Spring

Firmness rating: Soft  
 Mattress sizes: 120 / 140 x 200 cm.  
 The spring mattress is characterized by the soft comfort combined with effective pressure relief. Furthermore, the combination of fiberfill, a thin layer of foam, and the pocket springs ensure that the mattress is breathable and able to conduct moisture and heat away at night.



### Soft Spring

Firmness rating: Extra soft  
 Mattress sizes: 120 / 140 x 200 cm.  
 The Soft Spring mattress offers a unique comfort achieved through the combination of pocket springs and the built in topper of hyper soft foam. Choose our Soft Spring mattress for an extra soft comfort.



### Latex

Firmness rating: Medium  
 Mattress size: 140 x 200 cm.  
 A breathable natural core of high quality OEKO-TEX® latex ensures a durable mattress that adjusts to your body. Latex sleeps cooler than foam and reacts instantly to your every move. As Latex is derived from a sustainable resource, it is the eco-friendly choice. Choose our Latex mattress for a medium comfort.



## Non-detachable covers

### Nordic Mattress

This is the standard mattress look with pull downs. You decide the textile you like, and should you later happen to change your mind about style or color, you can choose between the two detachable cover options we offer. Available for all mattresses on page 160.



## Detachable covers

### Nordic Cover

This cover has a sleek, rounded surface with stylings in each of the corners of the mattress. It covers up your entire mattress, giving you the option of choosing a different color. Should you want to change the look, simply buy a new cover instead of a new mattress. Available for all mattresses on page 160.

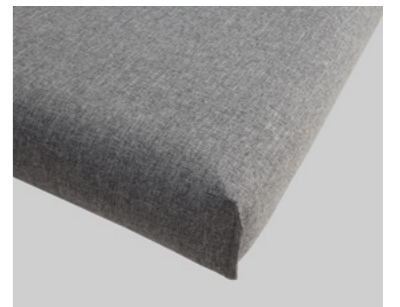

### Sharp Plus Cover

This cover has a sleek surface with stylings across the edges of the mattress. It covers up your entire mattress, giving you the option of choosing a different color. Should you want to change the look, simply buy a new cover instead of a new mattress. Available for all mattresses on page 160.



## Frame covers

A back frame cover is always included. If you prefer the full cover look, a seat frame cover can be purchased.

Back frame cover (always included)

Front seat cover (optional)

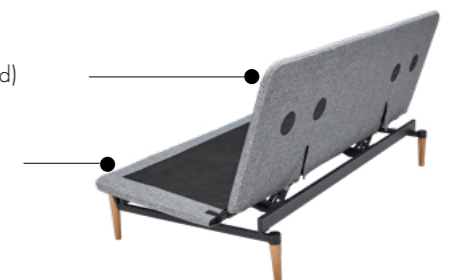

We place high value on ensuring that our fabrics all match the high quality of the design as well as durability of our sofa beds. All fabrics are enhanced with additional backing for extended life time and undergo rigid testing to meet the high standards we impose on our designs and production. In accordance with our Planet Promise we ensure that an increasing selection of fabrics are OEKO-TEX® certified.

For detailed fabric information please scan the QR code.



Name	Composition	Color fastness to light (scale 1-5)	Color fastness to rubbing (scale 1-5)	Martindale	OEKO-TEX®
Argus	100 % Recycled Polyester	4-5	4-5	67.000	•
Bouclé	55% Recycled polyester / 45% Polyester	5	4-5	27.000	•
Blida	80 % Polyester / 20 % Linen	4-5	4-5	200.000	•
Cordufine	85 % Polyester / 15 % Polyamide	4-5	5	100.000	•
Corduroy	100% Polyester	4-5	4	109.000	•
Elegance	100 % Polyester	4-5	4-5	60.000	•
Faunal	80 % Polyester / 17,5% Leather / 2,5 % Polyurethane	4-5	4	56.000	
Flashtex	100 % Polyester	4-5	4	116.000	•
Kenya	100 % Polyester	4-5	4-5	119.000	•
Micro Check	100 % Polyester	4-5	4-5	27.000	•
Mixed Dance	100 % Polyester	4-5	5	85.500	•
Nist	96 % Polyester / 4 % Linen	4-5	5	141.500	
Phobos	100 % Polyester	4-5	4-5	100.000	•
Soft	100 % Polyester	4-5	5	100.000	•
Twist	100 % Polyester	4-5	5	36.000	•
Weda	100 % Polyester	4-5	4-5	100.000	
Vivus	100 % Recycled Polyester	4-5	4-5	78.000	•

## Cleaning advisory

**Fabrics:** Machine washable at 30 degrees Celsius.

**Leather looks:** Wipe with a moist cloth, do not dry clean.

Please visit [innovationliving.com](http://innovationliving.com) for further information or scan the QR code below.



Please note that the printed presentation of the fabric texture and colors may vary from the actual fabric.

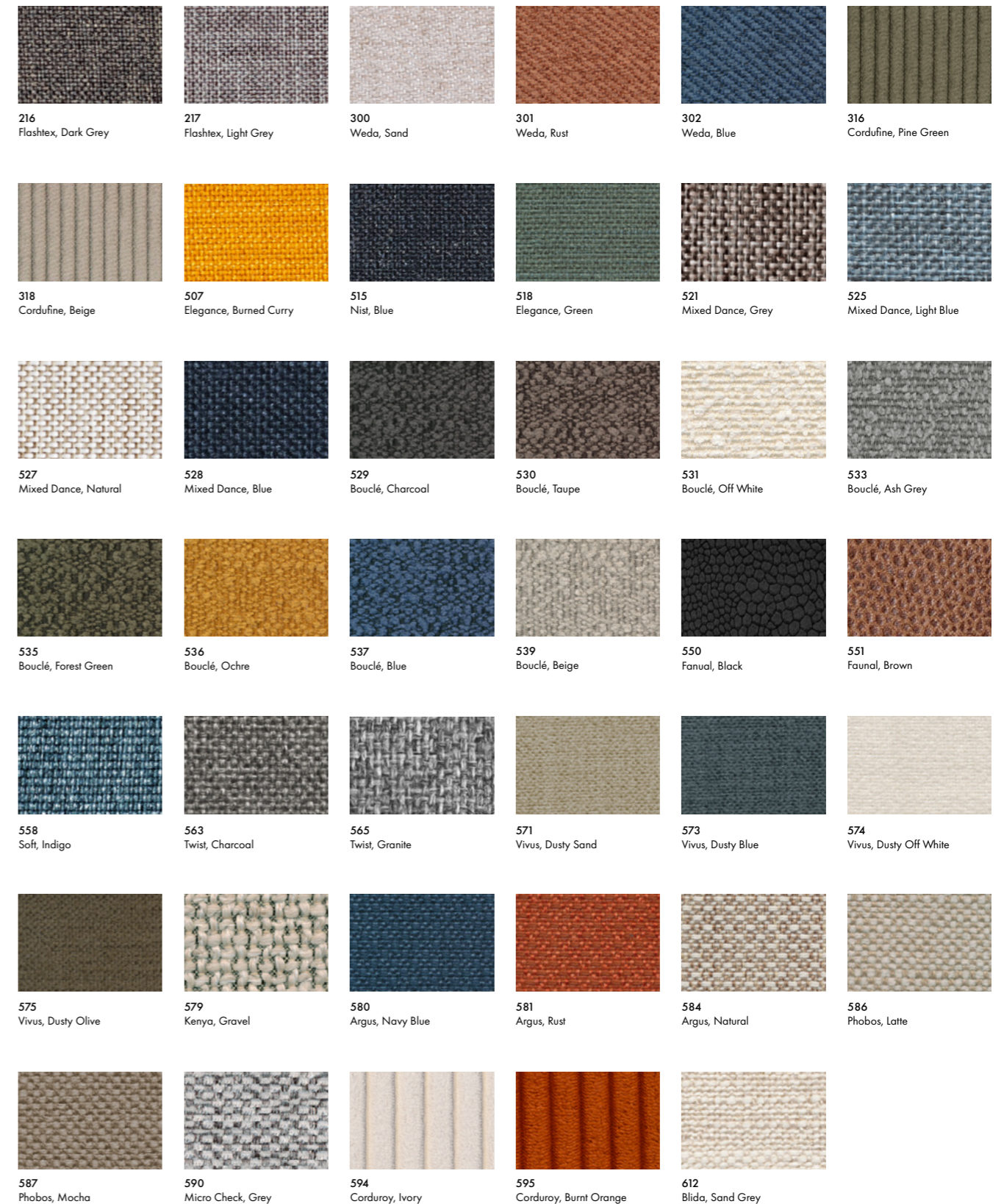

# Expand Your Living Space In Style

## Follow us on

[instagram.com/innovationliving](https://www.instagram.com/innovationliving)  
[facebook.com/innovationliving](https://www.facebook.com/innovationliving)  
[linkedin.com/company/innovation-living](https://www.linkedin.com/company/innovation-living)  
[pinterest.com/innovationtm](https://www.pinterest.com/innovationtm)

[www.innovationliving.com](http://www.innovationliving.com)

