



GAZZDA

Tink table

Product sheet

design by
Salih Teskeredžić



reddot award 2016
winner



Tink table

Product facts

Materials

Plate	Solid wood / Linoleum
Legs	Solid wood
Finish	Hardwax oil

Technical features

Plate

The table plate is fully made out of solid wood or linoleum (natural, warm to the touch, smooth, antibacterial surface material) glued on beech plywood. The solid wood plate option has steel stiffeners at the bottom side of the plate which prevent minor changes in the dimensions of the wooden parts over time due to the hygroscopy.

Legs and aprons

Legs and aprons are also made out of solid wood and are connected with stainless steel rod stretchers.

Finish

Available in two plant-based Hardwax oil finishes (colours), which retain the wood's natural state, as a white, natural and smoked oil

Cleaning

Please see [Product](#) or [Material](#) page on our website.

Notes to consider

Variations

Natural variations in wood color and surface may occur. Regular maintenance will ensure the wood preserves its authentic beauty and can last for generations.

Product changes

Please note that Gazzda reserves the right to alter construction and design without notice.

Dimensions (tolerances)

The dimensions shown are indicative, they may vary due to the natural properties of wood, season, or manufacturing processes. Deviations from the specified size may occur, usually no more than 1 cm.

For all additional inquiries regarding Tink table products please feel free to [contact us](#).

Tink table 160

Base Solid wood, Plate Solid wood / Linoleum



reddot award 2016
winner

Basic info

Design	Salih Teskeredžić	
Product size	W: 160, D: 90, H: 75	
Packaging	W: 165, D: 97, H: 13,5	
Volume	0,22 m ³	
Net weight	40,8 kg	30,6 kg
Gross weight	45,6 kg (wood)	35,4 kg (linoleum)



Item no. 03B / 09F / 378

Leg spacing	Width	Depth	Height
Floor level	130	67	
Seat height	110	47	
Stretcher T-joint	68	13	
Apron	97	34	

Assembly 15 min / 2 persons

Plate	Thickness
	2 / 2,5

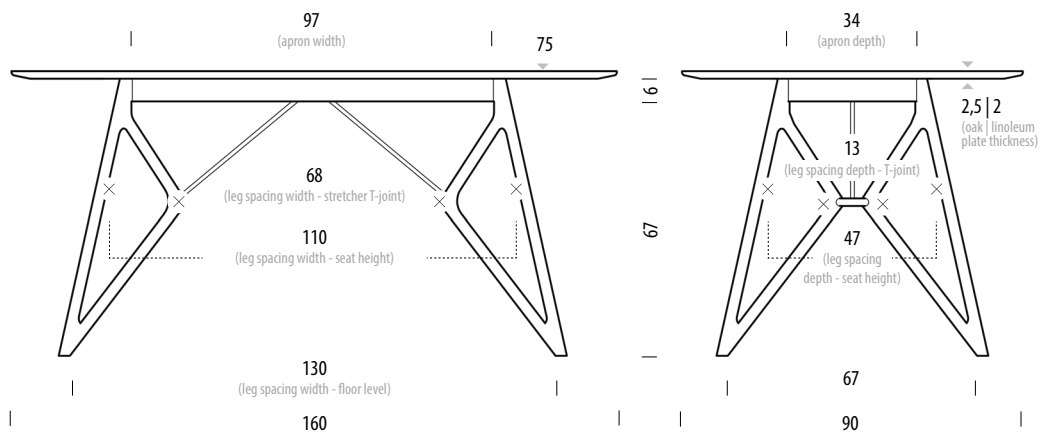

Selected options

Solid oak plate

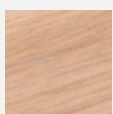

Oiled
1015
White oil

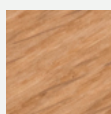

Oiled
1505
Natural oil

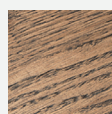

Oiled
163
Smoked oil

Linoleum plate



4023
Nero

Indicated materials and colours are selected by Gazzda as best-selling items. The lead time of selected options is 1-5 weeks. For an accurate lead time, please consult customer service.

For other material options, please see the Available materials section at the end of the product sheet.

Tink table 180

Base Solid wood, Plate Solid wood / Linoleum



reddot award 2016
winner

Basic info

Design	Salih Teskeredžić	
Product size	W: 180, D: 90, H: 75	
Packaging	W: 185, D: 97, H: 13,5	
Volume	0,24 m ³	
Net weight	44 kg	33 kg
Gross weight	49,4 kg (wood)	38,3 kg (linoleum)



Item no. 03C / 0A0 / 5A4

Assembly 15 min / 2 persons

Leg spacing	Width	Depth	Height
Floor level	150	67	
Seat height	130	47	
Stretcher T-joint	88	13	
Apron	117	34	

Plate	Thickness
	2 / 2,5

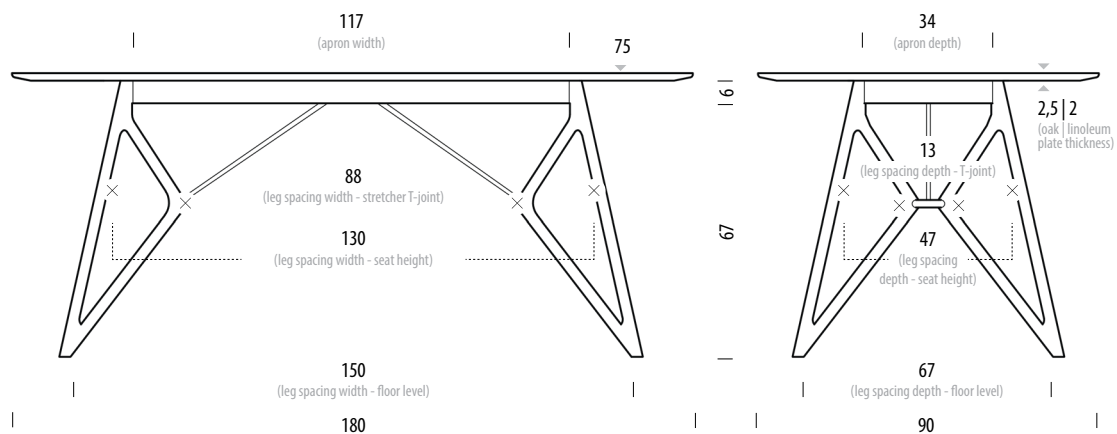

Selected options

Solid oak plate

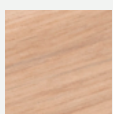

Oiled
1015
White oil

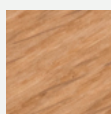

Oiled
1505
Natural oil

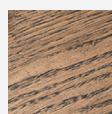

Oiled
163
Smoked oil

Linoleum plate



4023
Nero

Indicated materials and colours are selected by Gazzda as best-selling items. The lead time of selected options is 1-5 weeks. For an accurate lead time, please consult customer service.

For other material options, please see the Available materials section at the end of the product sheet.

Tink table 200

Base Solid wood, Plate Solid wood / Linoleum



reddot award 2016
winner

Version: 8-1-2024

Basic info

Design	Salih Teskeredžić	
Product size	W: 200, D: 90, H: 75	
Packaging	W: 205, D: 97, H: 13,5	
Volume	0,27 m ³	
Net weight	47,9 kg	36 kg
Gross weight	53,8 kg (wood)	41,9 kg (linoleum)



Item no. 03D / 0A1 / 5A5

Assembly 15 min / 2 persons

Leg spacing	Width	Depth	Height
Floor level	170	67	
Seat height	150	47	
Stretcher T-joint	108	13	
Apron	137	34	

Plate	Thickness
	2 / 2,5

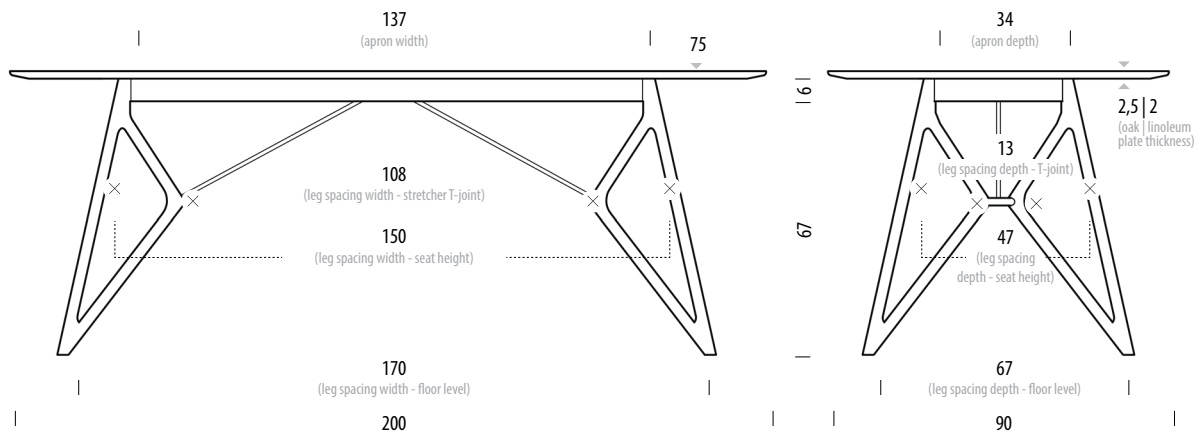

Selected options

Solid oak plate

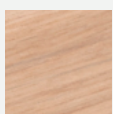

Oiled
1015
White oil

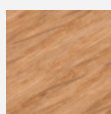

Oiled
1505
Natural oil

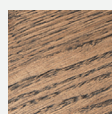

Oiled
163
Smoked oil

Linoleum plate



4023
Nero

Indicated materials and colours are selected by Gazzda as best-selling items. The lead time of selected options is 1-5 weeks. For an accurate lead time, please consult customer service.

For other material options, please see the Available materials section at the end of the product sheet.

Tink table 220

Base Solid wood, Plate Solid wood / Linoleum



reddot award 2016
winner

Version: 8-1-2024

Basic info

Design	Salih Teskeredžić	
Product size	W: 220, D: 90, H: 75	
Packaging	W: 225, D: 97, H: 13,5	
Volume	0,30 m ³	
Net weight	50,5 kg	38 kg
Gross weight	56,9 kg (wood)	44,4 kg (linoleum)



Item no. 03E / 0A2 / 5A6

Assembly 15 min / 2 persons

Leg spacing	Width	Depth	Height
Floor level	190	67	
Seat height	170	47	
Stretcher T-joint	128	13	
Apron	157	34	

Plate	Thickness
	2 / 2,5

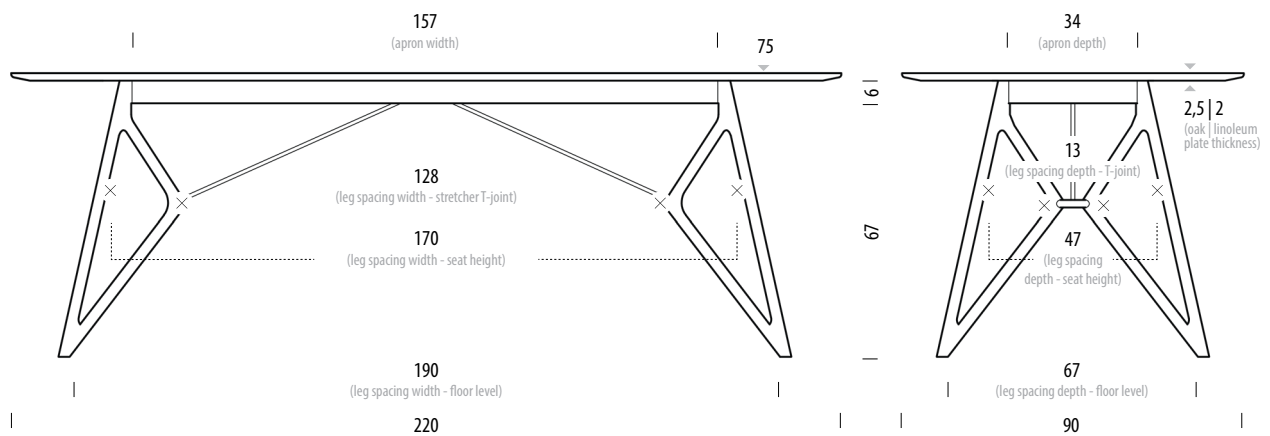

Selected options

Solid oak plate

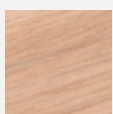

Oiled
1015
White oil

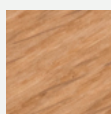

Oiled
1505
Natural oil

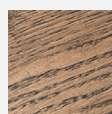

Oiled
163
Smoked oil

Linoleum plate



4023
Nero

Indicated materials and colours are selected by Gazzda as best-selling items. The lead time of selected options is 1-5 weeks. For an accurate lead time, please consult customer service.

For other material options, please see the Available materials section at the end of the product sheet.

Tink table 240

Base Solid wood, Plate Solid wood / Linoleum



reddot award 2016
winner

Version: 8-1-2024

Basic info

Design	Salih Teskeredžić	
Product size	W: 240, D: 90, H: 75	
Packaging	W: 245, D: 97, H: 13,5	
Volume	0,32 m ³	
Net weight	53,4 kg	40 kg
Gross weight	60,7 kg (wood)	47,3 kg (linoleum)



Item no. 3FD / 44E / 3D6

Assembly 15 min / 2 persons

Leg spacing	Width	Depth	Height
Floor level	210	67	
Seat height	190	47	
Stretcher T-joint	148	13	
Apron	177	34	

Plate	Thickness
	2 / 2,5

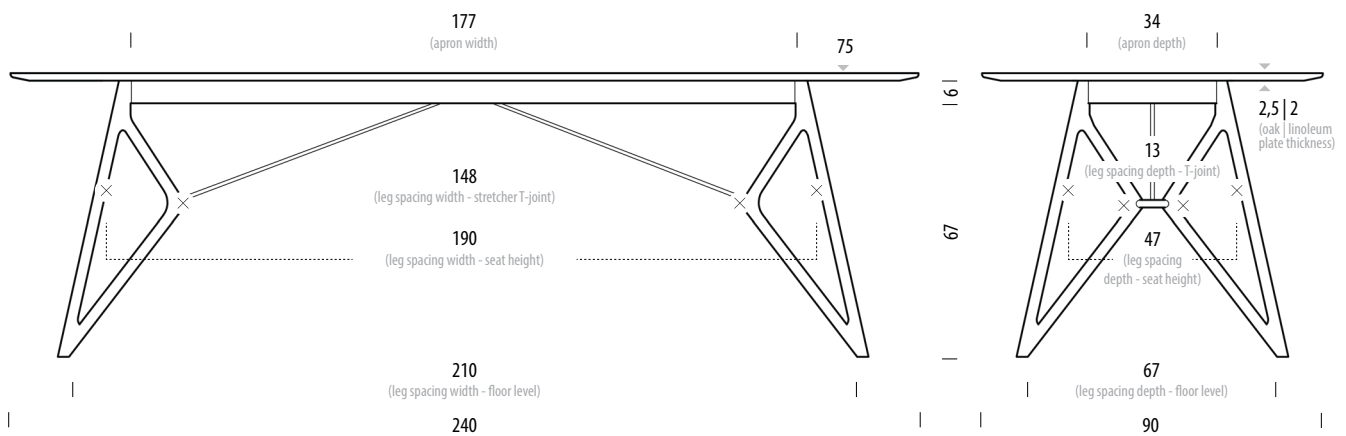

Selected options

Solid oak plate

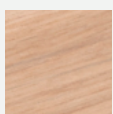

Oiled
1015
White oil

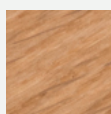

Oiled
1505
Natural oil

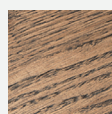

Oiled
163
Smoked oil

Linoleum plate



4023
Nero

Indicated materials and colours are selected by Gazzda as best-selling items. The lead time of selected options is 1-5 weeks. For an accurate lead time, please consult customer service.

For other material options, please see the Available materials section at the end of the product sheet.

Tink table

Seating overview - Muna chair | W: 53, D: 53, H: 75

0cm 100 140 160 180 200 220 240

Scale: 1:40

Version: 8-1-2024

Tink table 160 x 90 Size (cm)
Item no: 03B / 09F / 378 W: 160 D: 90 H: 75

deepest chair fit 4 chairs ↔ max. seating places 6 chairs

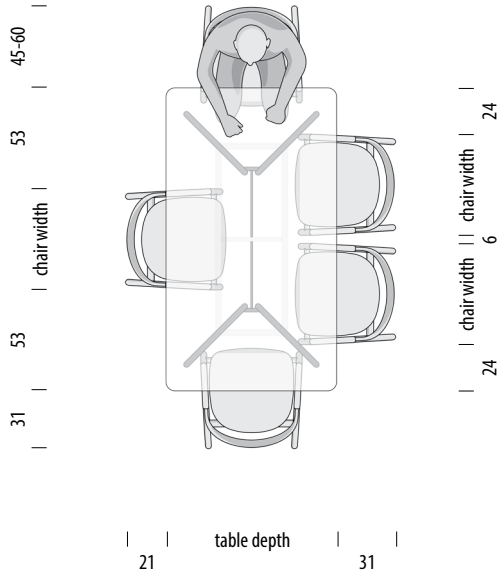

Tink table 180 x 90 Size (cm)
Item no: 03C / 0A0 / 5A4 W: 180 D: 90 H: 75

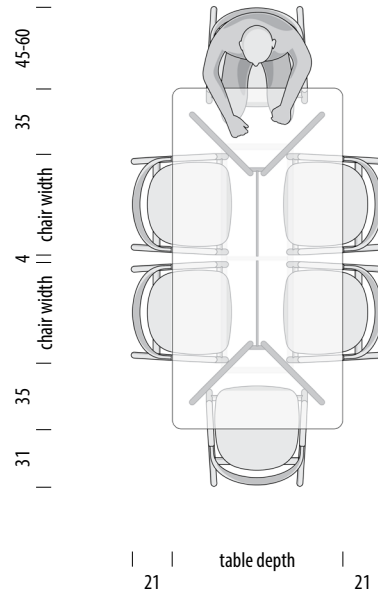

Tink table 200 x 90 Size (cm)
Item no: 03D / 0A1 / 5A5 W: 200 D: 90 H: 75

deepest chair fit 6 chairs ↔ max. seating places 8 chairs

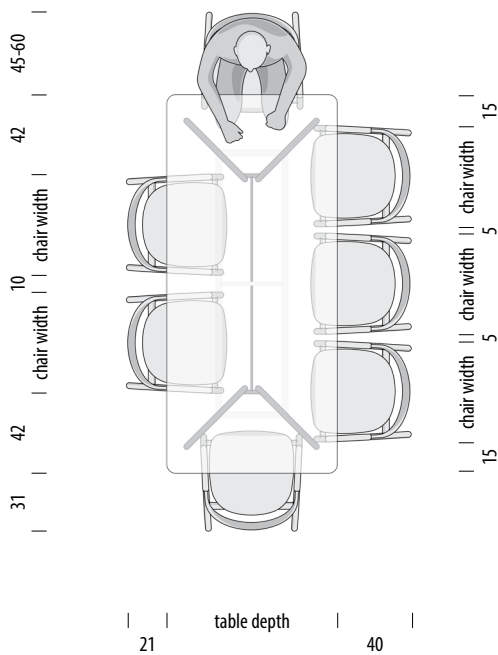

Tink table 220 x 90 Size (cm)
Item no: 03E / 0A2 / 5A6 W: 220 D: 90 H: 75

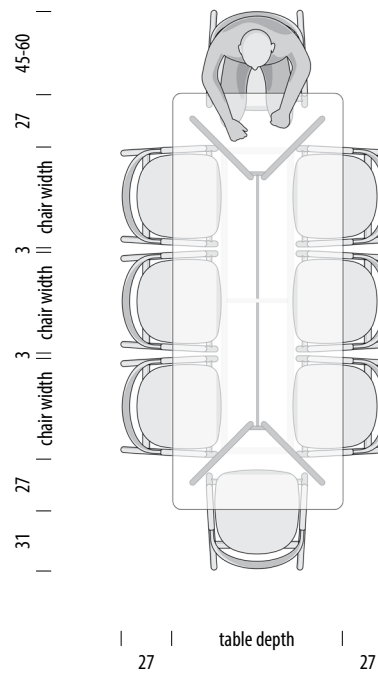

Tink table

Seating overview - Muna chair | W: 53, D: 53, H: 75

0cm 100 140 160 180 200 220 240

Scale: 1:40

Version: 8-1-2024

Tink table 240 x 90 **Size (cm)**
 Item no: 3FD / 44E / 3D6 W: 240 D: 90 H: 75

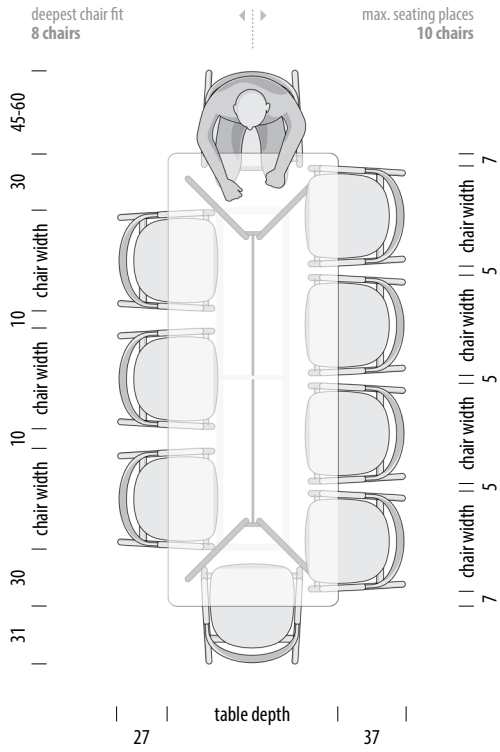

Tink table

Seating overview - Ava chair | W: 56, D: 53, H: 77

0cm 100 140 160 180 200 220 240

Scale: 1:40

Version: 8-1-2024

Tink table 160 x 90 Size (cm)
Item no: 03B / 09F / 378 W: 160 D: 90 H: 75

deepest chair fit 4 chairs ↔ max. seating places 6 chairs

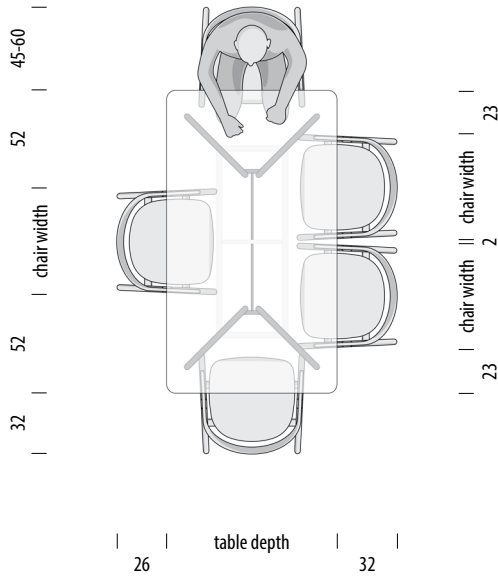

Tink table 180 x 90 Size (cm)
Item no: 03C / 0A0 / 5A4 W: 180 D: 90 H: 75

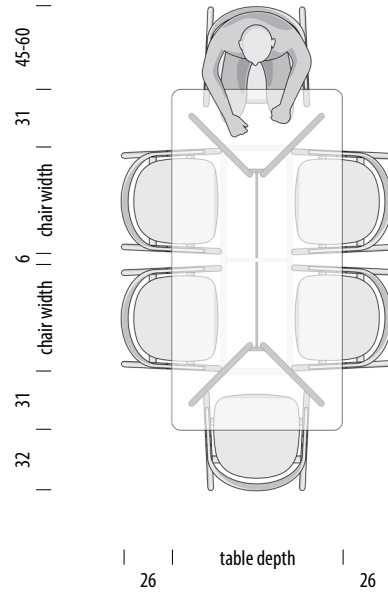

Tink table 200 x 90 Size (cm)
Item no: 03D / 0A1 / 5A5 W: 200 D: 90 H: 75

deepest chair fit 6 chairs ↔ max. seating places 8 chairs

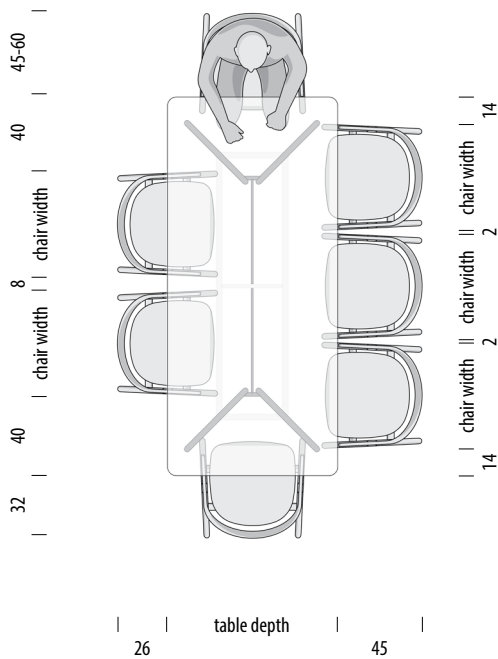

Tink table 220 x 90 Size (cm)
Item no: 03E / 0A2 / 5A6 W: 220 D: 90 H: 75

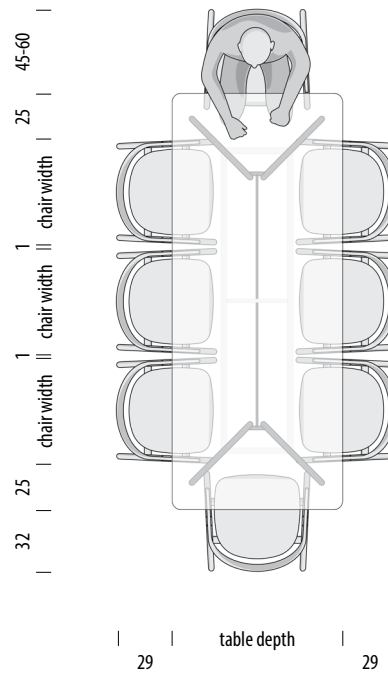

Tink table

Seating overview - Ava chair | W: 56, D: 53, H: 77

0cm 100 140 160 180 200 220 240

Scale: 1:40

Version: 8-1-2024

Tink table 240 x 90 **Size (cm)**
 Item no: 3FD / 44E / 3D6 W: 240 D: 90 H: 75

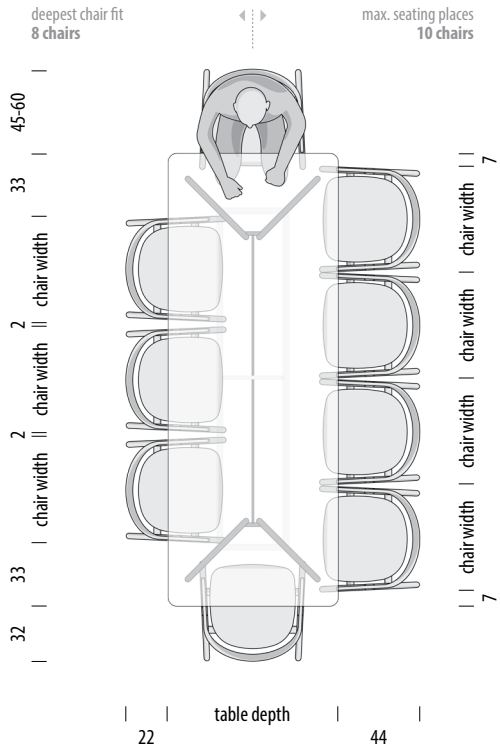

Tink table

Seating overview - Ava bench | W: 120, D: 53, H: 77,5

0cm 100 140 160 180 200 220 240

Scale: 1:40

Version: 8-1-2024

Tink table 160 x 90 Size (cm)
Item no: 03B / 09F / 378 W: 160 D: 90 H: 75

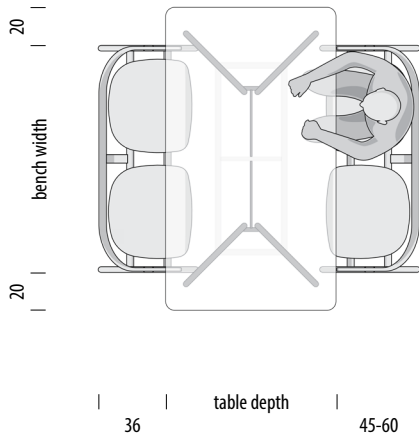

Tink table 180 x 90 Size (cm)
Item no: 03C / 0A0 / 5A4 W: 180 D: 90 H: 75

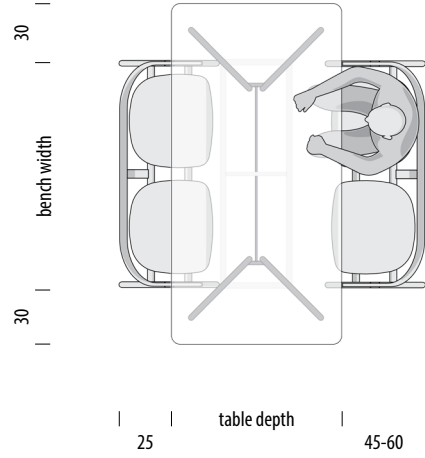

Tink table 200 x 90 Size (cm)
Item no: 03D / 0A1 / 5A5 W: 200 D: 90 H: 75

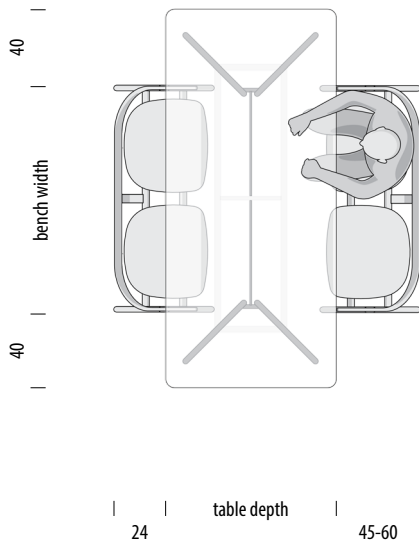

Tink table 220 x 90 Size (cm)
Item no: 03E / 0A2 / 5A6 W: 220 D: 90 H: 75

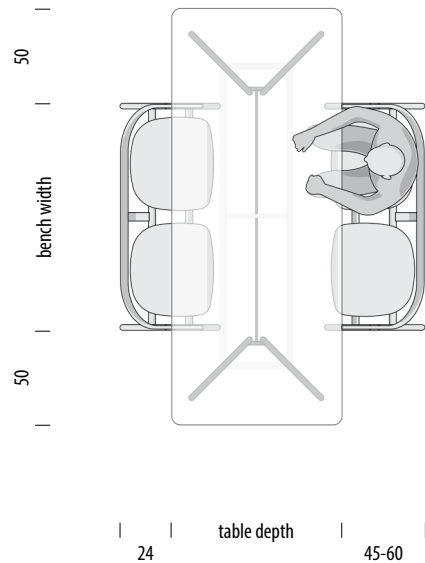

Tink table

Seating overview - Ava bench | W: 120, D: 53, H: 77,5

0cm 100 140 160 180 200 220 240

Scale: 1:40

Version: 8-1-2024

Tink table 240 x 90 **Size (cm)**
Item no: 3FD / 44E / 3D6 W: 240 D: 90 H: 75

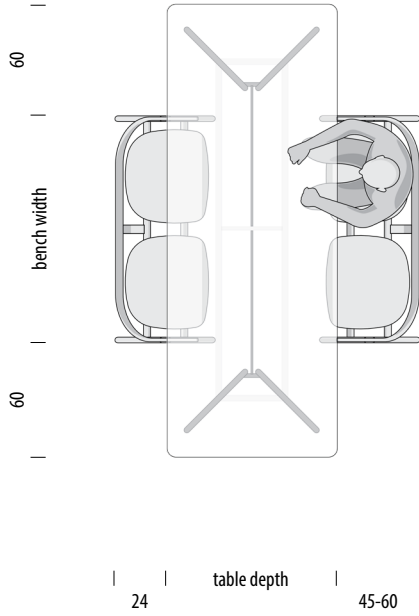

Tink table

Seating overview - Fawn chair | W: 48, D: 48, H: 79

0cm 100 140 160 180 200 220 240

Scale: 1:40

Version: 8-1-2024

Tink table 160 x 90 Size (cm)
Item no: 03B / 09F / 378 W: 160 D: 90 H: 75

deepest chair fit 4 chairs max. seating places 6 chairs

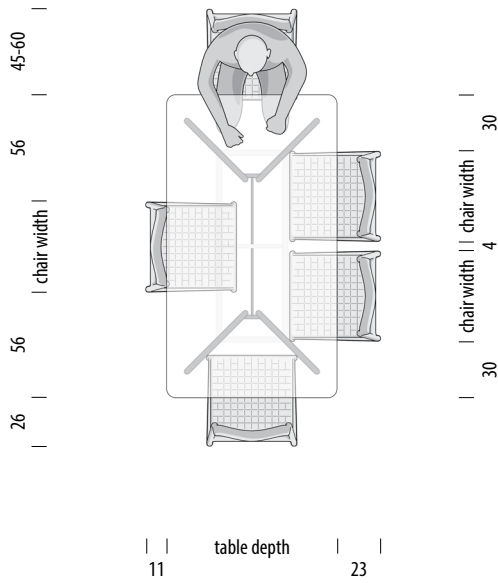

Tink table 180 x 90 Size (cm)
Item no: 03C / 0A0 / 5A4 W: 180 D: 90 H: 75

deepest chair fit 6 chairs max. seating places 8 chairs

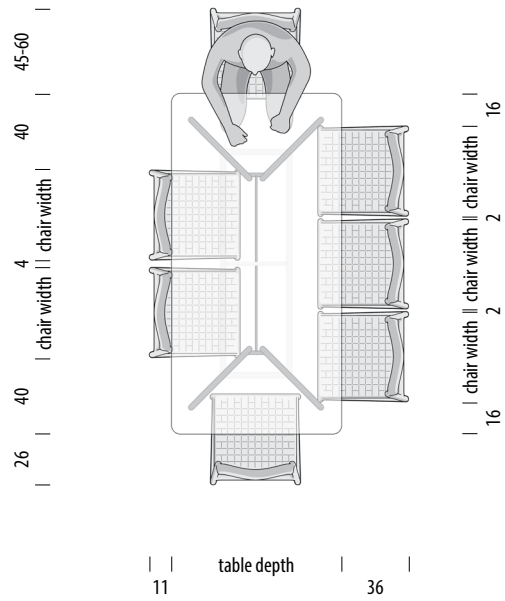

Tink table 200 x 90 Size (cm)
Item no: 03D / 0A1 / 5A5 W: 200 D: 90 H: 75

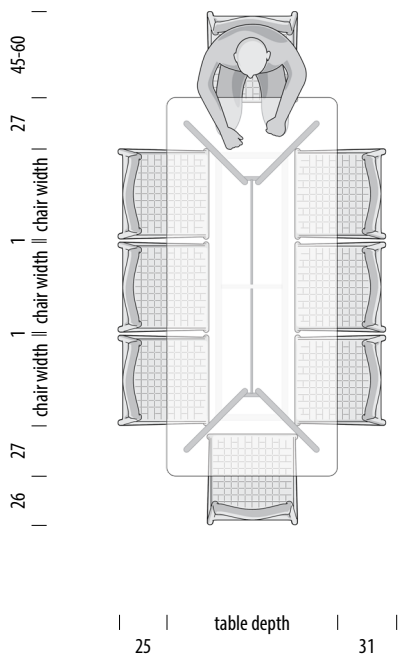

Tink table 220 x 90 Size (cm)
Item no: 03E / 0A2 / 5A6 W: 220 D: 90 H: 75

deepest chair fit 8 chairs max. seating places 10 chairs

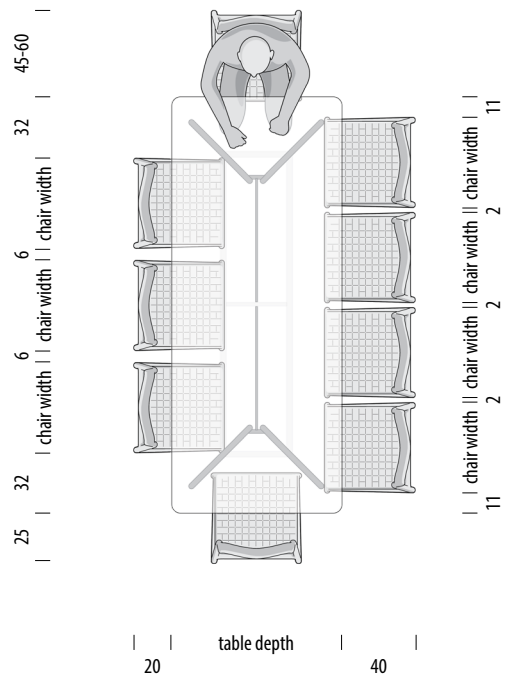

Tink table

Seating overview - Fawn chair | W: 48, D: 48, H: 79

0cm 100 140 160 180 200 220 240

Scale: 1:40

Version: 8-1-2024

Tink table 240 x 90 **Size (cm)**
 Item no: 3FD / 44E / 3D6 W: 240 D: 90 H: 75

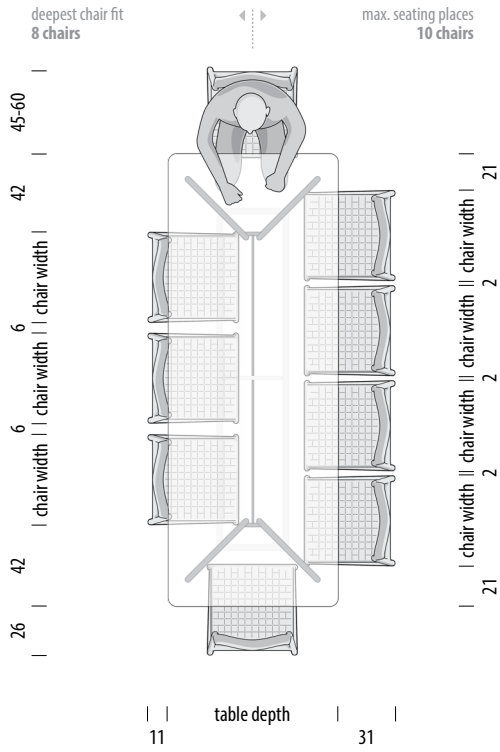

Tink table

Seating overview - Nora chair | W: 45, D: 47, H: 79

0cm 100 140 160 180 200 220 240

Scale: 1:40

Version: 8-1-2024

Tink table 160 x 90 Size (cm)
Item no: 03B / 09F / 378 W: 160 D: 90 H: 75

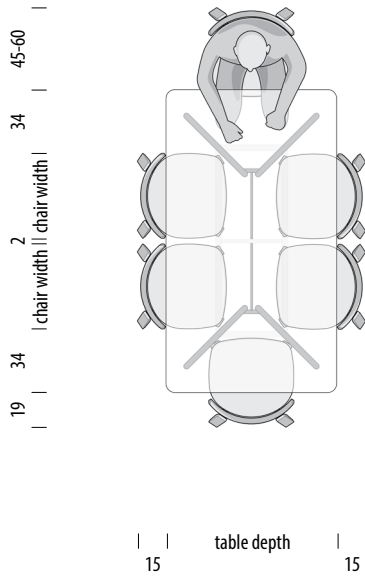

Tink table 180 x 90 Size (cm)
Item no: 03C / 0A0 / 5A4 W: 180 D: 90 H: 75

deepest chair fit 6 chairs | max. seating places 8 chairs

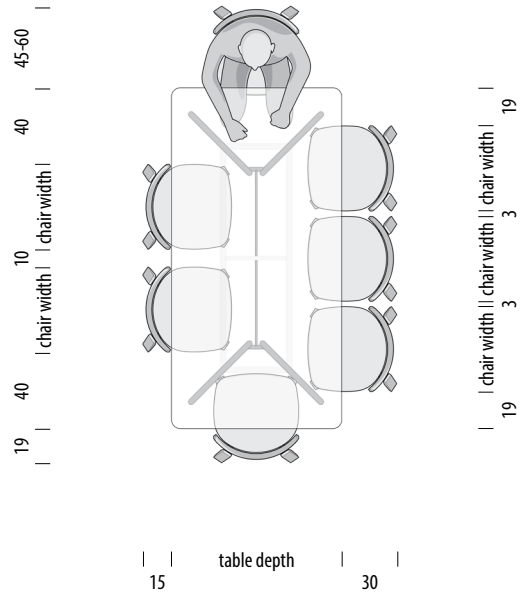

Tink table 200 x 90 Size (cm)
Item no: 03D / 0A1 / 5A5 W: 200 D: 90 H: 75

deepest chair fit 6 chairs | max. seating places 8 chairs

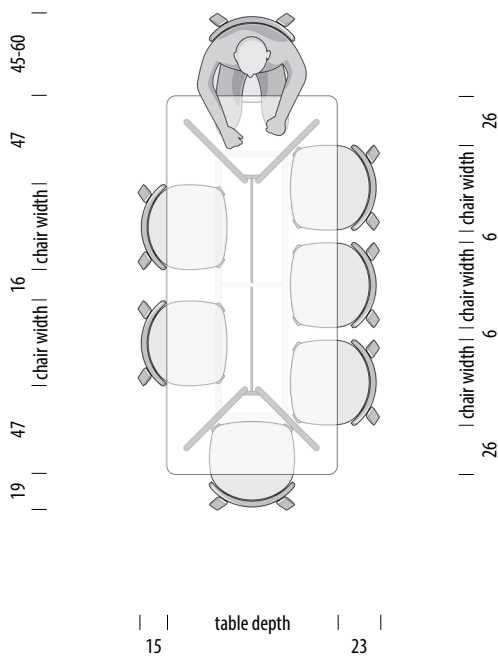

Tink table 220 x 90 Size (cm)
Item no: 03E / 0A2 / 5A6 W: 220 D: 90 H: 75

deepest chair fit 8 chairs | max. seating places 10 chairs

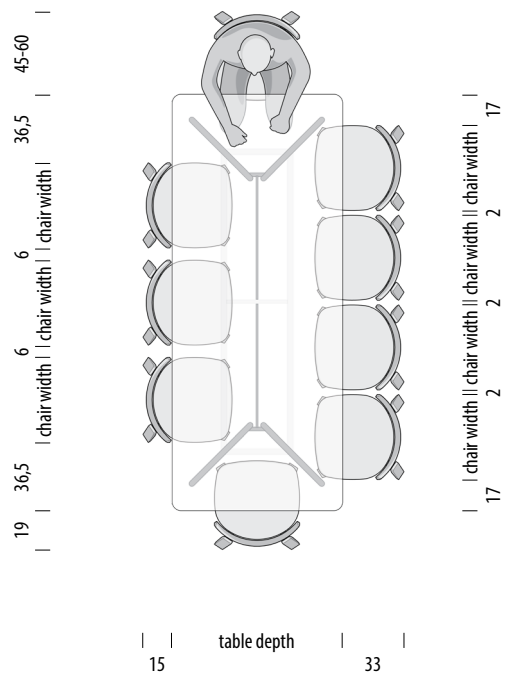

Tink table

Seating overview - Nora chair | W: 45, D: 47, H: 79

0cm 100 140 160 180 200 220 240

Scale: 1:40

Version: 8-1-2024

Tink table 240 x 90 **Size (cm)**
 Item no: 3FD / 44E / 3D6 W: 240 D: 90 H: 75

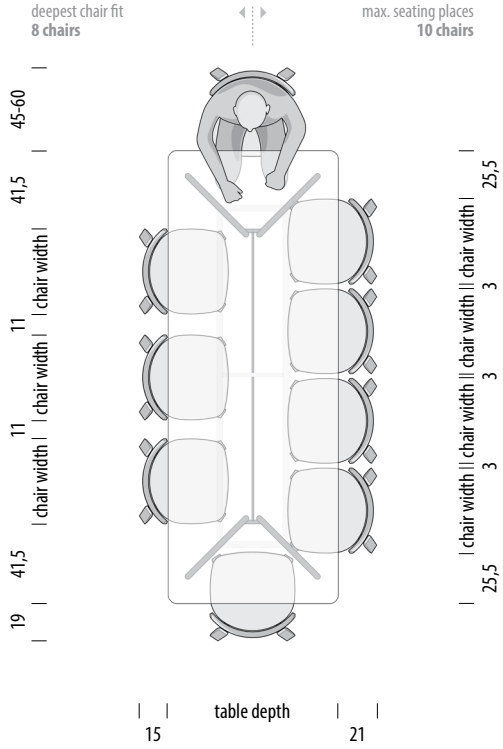

Tink table

Seating overview - Ena chair | W: 45, D: 56, H: 84

0cm 100 140 160 180 200 220 240

Scale: 1:40

Version: 8-1-2024

Tink table 160 x 90 Size (cm)
Item no: 03B / 09F / 378 W: 160 D: 90 H: 75

deepest chair fit 4 chairs
max. seating places 6 chairs

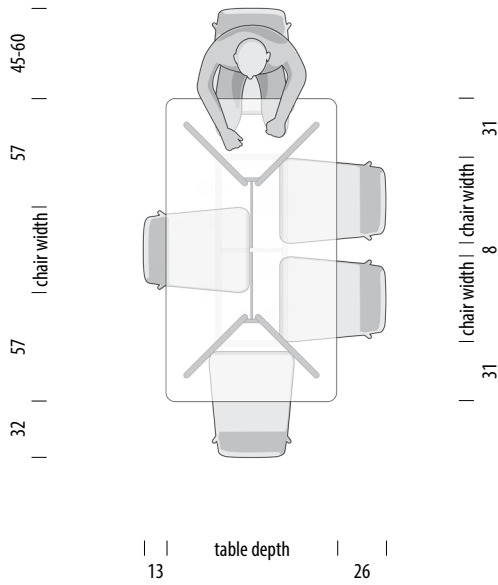

Tink table 180 x 90 Size (cm)
Item no: 03C / 0A0 / 5A4 W: 180 D: 90 H: 75

deepest chair fit 6 chairs
max. seating places 8 chairs

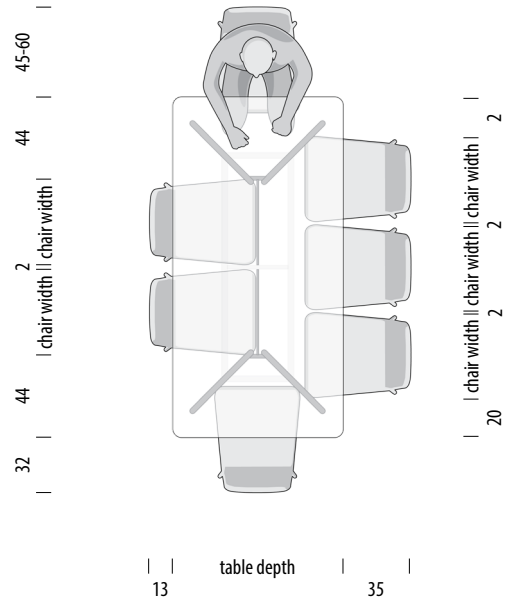

Tink table 200 x 90 Size (cm)
Item no: 03D / 0A1 / 5A5 W: 200 D: 90 H: 75

deepest chair fit 6 chairs
max. seating places 8 chairs

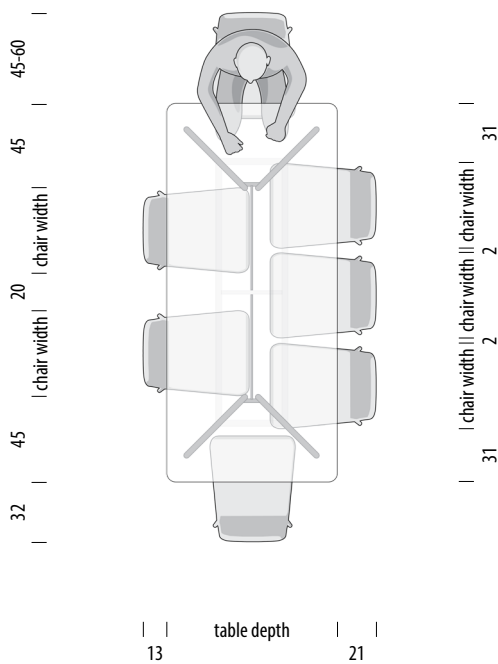

Tink table 220 x 90 Size (cm)
Item no: 03E / 0A2 / 5A6 W: 220 D: 90 H: 75

deepest chair fit 8 chairs
max. seating places 10 chairs

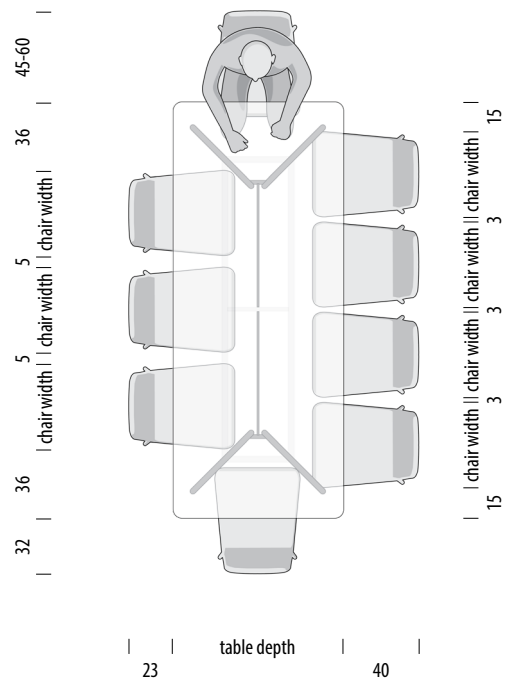

Tink table

Seating overview - Ena chair | W: 45, D: 56, H: 84

0cm 100 140 160 180 200 220 240

Scale: 1:40

Version: 8-1-2024

Tink table 240 x 90 **Size (cm)**
 Item no: 3FD / 44E / 3D6 W: 240 D: 90 H: 75

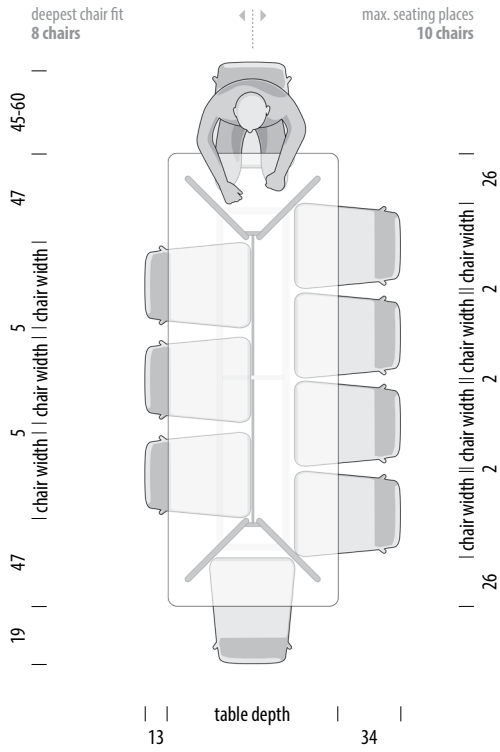

Available materials

Legs | Solid wood

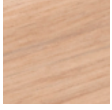

Oiled
1015
White oil

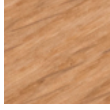

Oiled
1505
Natural oil

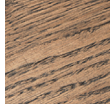

Oiled
163
Smoked oil



European walnut
1505
Natural oil

Plate | Solid wood



Oiled
1015
White oil

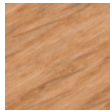

Oiled
1505
Natural oil

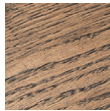

Oiled
163
Smoked oil

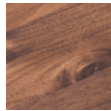

European walnut
1505
Natural oil

Plate | Desktop linoleum - by Forbo



4176
Mushroom



4184
Dark olive



4179
Smokey blue



4023
Nero