



NEMOSTUDIO

Architectural Lighting

Nemo Studio was born from thirty-year research experience led by Ilti Luce in Turin, a company that has constantly dedicated itself to the development of innovative and sustainable technologies which have brought it to be among the pioneers of optical fiber and LED in the world. For over 10 years within the Philips Group, the company has contributed to the implementation of cutting-edge projects for cultural institutions such as the Louvre in Paris, the Palace of Versailles, the Egyptian Museum, the Royal Armory and Palazzo Madama in Turin. All projects have high technological and aesthetic content on the basis of which new paradigms have been defined, especially related to museums and artwork lighting. Based on this unique experience, Nemo Studio today is a reality strongly focused on the study of lighting solutions for the hospitality, retail and outdoor sectors, with a deep vocation for special custom-made projects. In 2020 Ilti Luce joins Nemo Lighting and this first Nemo Studio catalogue presents collections of products and solutions extensively tested in projects on behalf of the most prestigious museums in the world, private collections as well as public and commercial spaces. The wide range of professional products offers new lighting solutions for the most complex environments, capable of responding to various display and use needs. The design challenge is part of Nemo Studio's spirit, through tested production capabilities and a constantly updated design and know-how.

Nemo Studio nasce dall'esperienza di ricerca trentennale della Ilti Luce di Torino, azienda che si è costantemente dedicata allo sviluppo di tecnologie innovative e sostenibili che l'hanno portata a essere tra i pionieri della fibra ottica e del LED nel mondo. Per oltre 10 anni all'interno del Gruppo Philips, l'azienda ha contribuito alla realizzazione di progetti all'avanguardia, per istituzioni quali il Louvre di Parigi, la Reggia di Versailles, il Museo Egizio, l'Armeria Reale e Palazzo Madama a Torino. Si tratta di realizzazioni con elevati contenuti tecnologici ed estetici e che hanno definito nuovi paradigmi, soprattutto per l'illuminazione museale e delle opere d'arte. Sulla base di quest'esperienza così unica, Nemo Studio oggi è una realtà fortemente focalizzata sullo studio di soluzioni illuminotecniche nell'hospitality, nel retail e nell'outdoor, con una forte vocazione alla realizzazione di progetti speciali. A partire dal 2020, Ilti Luce entra a far parte di Nemo Lighting e questo primo catalogo Nemo Studio presenta collezioni di prodotti e soluzioni ampiamente testate in progetti per conto dei più prestigiosi musei del mondo, collezioni private e spazi pubblici e commerciali. L'ampia gamma di apparecchi professionali offre spunti per l'idonea illuminazione degli ambienti più complessi, in grado di rispondere alle diverse esigenze espositive e di utilizzo. La sfida progettuale fa parte dello spirito di Nemo Studio, attraverso capacità produttive testate e con un design e know-how in costante aggiornamento.

Nemo Studio entsteht aus der dreißigjährigen Erfahrung in der Forschung von Ilti Luce in Turin, einem Unternehmen, das sich ständig die Entwicklung innovativer und nachhaltiger Technologien verschrieben hat, die es zu einem der Vorreiter der Glasfaser- und LED-Technik weltweit gemacht haben. 10 Jahre lang gehörte das Unternehmen zur Philips-Gruppe und hat dazu beigetragen, hochmoderne Projekte für Institutionen wie den Louvre in Paris, das Schloss von Versailles, das Ägyptische Museum, die Königliche Waffenkammer und den Palazzo Madama in Turin zu realisieren. Diese Projekte von hohem technologischem und ästhetischem Wert haben neue Paradigmen definiert, insbesondere im Bereich der Museums- und der Kunstwerksbeleuchtung. Durch diese einzigartige Erfahrung ist Nemo Studio heute ein Unternehmen, das sich stark auf die Entwicklung von Beleuchtungslösungen im Bereich Hospitality, Retail und Outdoor spezialisiert hat und sich auf die Ausführung von besonderen Projekten konzentriert. 2020 wurde Ilti Luce von Nemo Lighting übernommen. Dieser erste Nemo Studio Katalog präsentiert verschiedene Kollektionen von Produkten und Lösungen, die in den renommiertesten Museen der Welt, in privaten Sammlungen sowie in öffentlichen und kommerziellen Bereichen ausgiebig getestet wurden. Das umfangreiche Angebot an professionellen Leuchten bietet optimale Lösungen für die verschiedensten Bereiche und komplexen Anforderungen. Mit geprüften Design- und Produktionsfähigkeiten und einem ständig-aktualisiertem Know-how stellt sich Nemo Studio der Herausforderung mit Leidenschaft.

Nemo Studio naît de l'expérience de trente ans de recherche d'Ilti Luce de Turin, une entreprise qui s'est toujours consacrée au développement de technologies innovantes et durables l'amenant ainsi à figurer parmi les pionniers de la fibre optique et de la LED dans le monde. Au-delà des 10 ans au sein du groupe Philips, l'entreprise a également contribué à la mise en œuvre de projets de pointe, pour des institutions telles que Le Louvre à Paris, le Château de Versailles, le Musée Égyptien, l'Armurerie Royale et le Palais Madama de Turin. Ces projets ont un contenu technologique et esthétique élevé sur la base duquel de nouveaux paradigmes ont été définis, en particulier liés aux musées et à l'éclairage des œuvres d'art.. Fort de cette expérience unique, Nemo Studio est aujourd'hui fortement centrée aussi sur l'étude de solutions d'éclairage dans hôtellerie, dans le secteur des magasins de détail, dans l'outdoor, avec une forte vocation pour la réalisation de projets spéciaux. À partir de 2020, Ilti Luce rejoint Nemo Lighting et ce premier catalogue Nemo Studio présente des collections de produits et de solutions largement testées dans des projets tels des musées les plus prestigieux du monde, des collections privées et des espaces publics et commerciaux. La large gamme de luminaires professionnels offre des idées pour l'éclairage approprié des environnements les plus complexes, capables de répondre aux différents besoins d'exposition et d'utilisation. Le défi de conception fait partie de l'esprit de Nemo Studio, à travers des capacités de production testées et une constante mise à jour de la conception et du savoir-faire.



THE CULTURAL AND SPORTS CENTER WANGARI MAATHAI

*The cultural and sports center Wangari Maathai is located in one of the highest density area of Paris, it does not host diversity – of activities, architectures, populations, uses – which could define it as a urban and sustainable neighborhood. Compact, the project becomes landmark in this dense neighborhood ; it saves ground, real resource of the area. By the transparency and porosity of its urban hall, the centre invites, welcomes and links populations and uses. Along its four faces, the project offers and stacks a range of materialities, more or less transparent, in relation with the different activities. Generosity as a common denominator of all spaces, to allow reinterpretation and refurbishment following evolutions of uses and needs. It is a single volume, with slightly curved faces, expressing the superposition of distinct functions in elevation, with strips surrounding the building.**

Bruther is an agency founded in 2007 in Paris by Stéphanie Bru and Alexandre Theriot. They practice an architecture of resistance, free from all traces of mannerism, style, fashion and the superfluous. Their projects are open infrastructures capable of responding to a multitude of possible futures and a great malleability of uses. Bruther is part of a ‘new wave’ of practices that contribute to a radical renewal of architectural culture in France. In 2018, they obtained the « Equerre d’argent » price for the Residence for researchers in Paris XIV.

**Extract text description provided by Studio Bruther*



The cultural and sports center Wangari Maathai, Paris



LE MUSÉE DÉPARTEMENTAL DE LA PRÉHISTOIRE

Architectural manifesto of the second modernism, the 'Musée départemental de la Préhistoire', built by Roland Simounet in Nemours (France) between 1976 and 1980, was born from a new museological thought, that of Georges-Henri Rivière, inventor of the ecomuseums.

Going beyond the simple technical response to the program, the rudimentary expression of this work emerges from a true architectural narrative. Listed in the supplementary inventory of historical monuments since 2002 and labeled "20th century heritage", the building reveals Simounet's taste for empirical subjects. In addition to pure functionalism, the syncretism of form and structure is the privilege of architecture. Borrowing from both the profane and the sacred, it alludes to both the figure of a fortified medieval castle and that of an ancient temple surrounded by nature, thus reviewing the basics of its practice.

The collections are set up with Roland Simounet, who designed the museum's furniture and all the museology. The perfect integration of the wall showcases with the architecture reinforces unity of this presentation for which only gray, black and white are present in order to enhance the colours and patinas of the archaeological pieces, as well as the environment of the courtyards and the park that surround the museum. The large and wide glass windows that frame the landscape, alternate with the circuit of windows that connect the archaeological pieces.

Today the weathered concrete is fond of the surrounding vegetation and the millennial rocks of the park.



THE LINEAR COLLECTION

INDOOR

PENDANT



ZIRKOL
p.12

ZIRKOL
CUSTOM
p.42

SLACKLINE
p.160

WALL/CEILING/
RECESSED



SLACKLINE
p.161

WALL/CEILING/
RECESSED

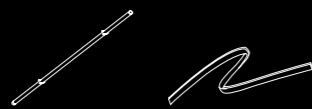

MINIFLUX
p.185

RIGA
p.215

RECESSED

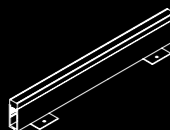

WALKLINE
p.195

OUTDOOR

THE MUSEUM COLLECTION

INDOOR

TRACK

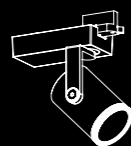

SHARP
p.165

SURFACE/
CEILING



LED EYE
p.179

THE SPOTLIGHT COLLECTION

INDOOR

RECESSED



ALICUDI
p.109

SALINA
p.113

LIPARI
p.117

DRAGSTER-T
p.235

GILDOR
p.241

LUX
INDOOR
p.124

FLOOR



PLINT
p.79

TRACK/
CEILING



VULCANO
p.70

ELBA
p.72

CAPRI
p.76

FLEX
p.87

OUTDOOR

RECESSED



LUX
OUTDOOR
p.130

LUX R
p.134

SKILLED
p.2223

WALKBY
p.209

SURFACE/
CEILING



LUX S
p.146

KIROPS
CEILING
p.229

WALL

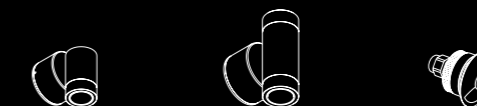

LUX W-S
p.138

LUX W-D
p.142

WALKWAY
p.203

GROUND



LUX GARDEN
p.150



La collezione di lampade a sospensione ZIRKOL nasce con forma circolare e si estende a molteplici figure. È composta da diversi elementi con una struttura in alluminio precisa ed elegante.

ZIRKOL racchiude il perfetto equilibrio tra design e illuminazione, combinazione che la rende irrinunciabile nel mondo dell'architettura e dell'interior design.

La collezione ZIRKOL è adatta a qualsiasi tipo di applicazione indoor in ambienti residenziali e pubblici.

Ogni prodotto è disponibile in diverse finiture e dimensioni. Tutte le forme ZIRKOL sono realizzate con lo stesso profilo per unire design ed estetica. Disponibile sia con emissione singola downlight, sia doppia uplight/downlight per garantire un comfort visivo più omogeneo.

The ZIRKOL suspension lamp family emerges from the evolution of the classic round luminaire with its precise and elegant frame and extends to several different aluminum shapes.

With its variable sizes, finishes and light emission, the ZIRKOL family represents the optimal balance between design and lighting, making it essential in the world of architecture and interior design.

ZIRKOL is suitable for any kind of application, both in residential and public spaces.

Each model is available in different sizes and finishes.

All ZIRKOL shapes are made from the same aluminum profile to unify design and aesthetic.

Available with a single downlight emission and with double emission for a more homogeneous visual comfort.

Die Pendelleuchten-Kollektion ZIRKOL entsteht aus der kreisförmigen Form und erstreckt sich auf mehrere unterschiedliche Versionen. Sie besteht aus mehreren Formen mit einer präzisen und eleganten Aluminiumstruktur.

ZIRKOL verkörpert die perfekte Balance zwischen Design und Beleuchtung, eine Kombination, die sie in der Welt der Architektur und Innenarchitektur unverzichtbar macht. Die ZIRKOL-Kollektion ist für jede Art von Innenanwendung im Wohnbereich und in öffentlichen Räumen geeignet. Jedes Produkt ist in verschiedenen Ausführungen und Größen erhältlich. Alle ZIRKOL-Formen werden mit dem gleichen Profil hergestellt und verbinden somit Design und Ästhetik. Erhältlich mit einfachem Downlight oder doppeltem Uplight/Downlight-Ausgang, um einen homogenen Sehkomfort zu gewährleisten.

La collection de suspensions ZIRKOL naît de la forme circulaire classique et s'agrandit à de multiples figures. Elle est composée de divers éléments avec une structure en aluminium précise et élégante. ZIRKOL réunit l'équilibre parfait entre le design et l'éclairage, qui la rend essentielle dans le monde de l'architecture et du design d'intérieur. La collection ZIRKOL est adaptée à toutes les applications indoor dans les espaces résidentiels ou publics. Chaque produit est disponible en différentes finitions et dimensions. Toutes les formes ZIRKOL sont réalisées avec le même profilé pour unir design et esthétique. Disponible soit en émission simple directe soit en double émission directe/indirecte pour garantir un confort visuel plus homogène.



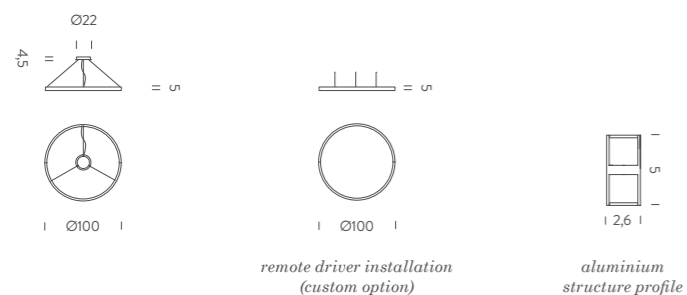

HOME - CIRCLE | 1m

DOWNLIGHT

CCT	max power	source	voltage	lum. flux	CRI	switching	code	finish
2700K	45W	linear LED	110/240V	2616lm	90	DALI 1-100%	BZRC1610G15DBO	white
							BZRC1610G15DNE	black
							BZRC1610G15DOR	matt gold
3000K				2769lm			BZRC1610G15WBO	white
							BZRC1610G15WNE	black
							BZRC1610G15WOR	matt gold
4000K				3077lm			BZRC1610G15NBO	white
							BZRC1610G15NNE	black
							BZRC1610G15NOR	matt gold

note RAL 9005 black | RAL 9016 white | shipped assembled

included round canopy with 1 x driver WALIMLED100/24 | 1 x dimmer interface WDIMDALIHP | 1 x electrical cable 4m | 3 x adjustable metal cables (length from 3m to 0,5m)

customizations optional accessories and customizable features on p.58-61

◆ IP40

UP-DOWNLIGHT

CCT	max power	source	voltage	lum. flux	CRI	switching	code	finish
2700K	90W	linear LED	110/240V	5231lm	90	DALI 1-100%	BZRC1710G15DBO	white
							BZRC1710G15DNE	black
							BZRC1710G15DOR	matt gold
3000K				5539lm			BZRC1710G15WBO	white
							BZRC1710G15WNE	black
							BZRC1710G15WOR	matt gold
4000K				6154lm			BZRC1710G15NBO	white
							BZRC1710G15NNE	black
							BZRC1710G15NOR	matt gold

note RAL 9005 black | RAL 9016 white | shipped assembled

included round canopy with 1 x driver WALIMLED100/24 | 1 x dimmer interface WDIMDALIHP | 1 x electrical cable 4m | 3 x adjustable metal cables (length from 3m to 0,5m)

customizations optional accessories and customizable features on p.58-61

◆ IP40

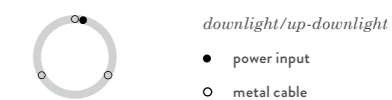
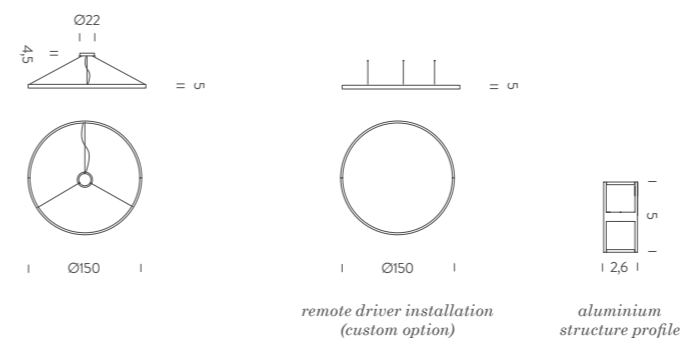

HOME - CIRCLE | 1,5m

DOWNLIGHT

CCT	max power	source	voltage	lum. flux	CRI	switching	code	finish
2700K	68W	linear LED	110/240V	3923lm	90	DALI 1-100%	BZRC1615G15DBO	white
							BZRC1615G15DNE	black
							BZRC1615G15DOR	matt gold
3000K				4154lm			BZRC1615G15WBO	white
							BZRC1615G15WNE	black
							BZRC1615G15WOR	matt gold
4000K				4616lm			BZRC1615G15NBO	white
							BZRC1615G15NNE	black
							BZRC1615G15NOR	matt gold

note RAL 9005 black | RAL 9016 white | shipped assembled

included round canopy with 1 x driver WALIMLED100/24 | 1 x dimmer interface WDIMDALIHP | 1 x electrical cable 4m | 3 x adjustable metal cables (length from 3m to 0,5m)

customizations optional accessories and customizable features on p.58-61

◆ IP40

UP-DOWNLIGHT

CCT	max power	source	voltage	lum. flux	CRI	switching	code	finish
2700K	136W	linear LED	220/240V	7847lm	90	DALI 1-100%	BZRC1715G15DBO	white
							BZRC1715G15DNE	black
							BZRC1715G15DOR	matt gold
3000K				8308lm			BZRC1715G15WBO	white
							BZRC1715G15WNE	black
							BZRC1715G15WOR	matt gold
4000K				9232lm			BZRC1715G15NBO	white
							BZRC1715G15NNE	black
							BZRC1715G15NOR	matt gold

note RAL 9005 black | RAL 9016 white | shipped assembled

included round canopy with 1 x driver WALIM150W24VIN | 1 x dimmer interface WDIMDALIHP | 1 x electrical cable 4m | 3 x adjustable metal cables (length from 3m to 0,5m)

customizations optional accessories and customizable features on p.58-61

◆ IP40

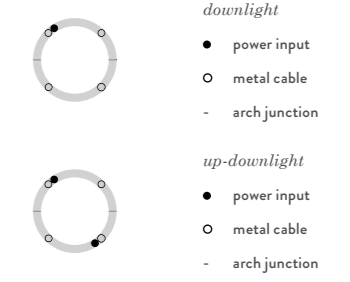
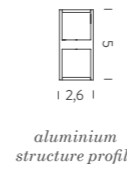
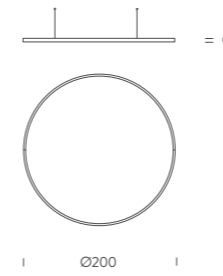

CIRCLE | 2m

DOWNLIGHT

CCT	max power	source	voltage	lum. flux	CRI	switching	code	finish
2700K	90W	linear LED	110/240V	5260lm	90	DALI 1-100%	BZRC1620G15DBO	white
							BZRC1620G15DNE	black
							BZRC1620G15DOR	matt gold
3000K				5539lm			BZRC1620G15WBO	white
							BZRC1620G15WNE	black
							BZRC1620G15WOR	matt gold
4000K				6154lm			BZRC1620G15NBO	white
							BZRC1620G15NNE	black
							BZRC1620G15NOR	matt gold

note remote driver | RAL 9005 black | RAL 9016 white | shipped in 2 pieces

included 1 x driver WALIMLED100/24 | 1 x dimmer interface WDIMDALIHP | 1 x electrical cable 5m | 4 x adjustable metal cables length 3m (including ceiling attachment)

optional accessory driver box | ceiling plate for remote driver (more specification at p.58-59)

customizations find customizable features on p.60-61

IP40

UP-DOWNLIGHT

CCT	max power	source	voltage	lum. flux	CRI	switching	code	finish
2700K	180W	linear LED	220/240V	10500lm	90	DALI 1-100%	BZRC1720G15DBO	white
							BZRC1720G15DNE	black
							BZRC1720G15DOR	matt gold
3000K				11078lm			BZRC1720G15WBO	white
							BZRC1720G15WNE	black
							BZRC1720G15WOR	matt gold
4000K				12309lm			BZRC1720G15NBO	white
							BZRC1720G15NNE	black
							BZRC1720G15NOR	matt gold

note remote driver | RAL 9005 black | RAL 9016 white | shipped in 2 pieces

included 1 x driver WALIM250W24VIN | 1 x dimmer interface WDIMDALIHP | 2 x electrical cables 5m | 4 x adjustable metal cables length 3m (including ceiling attachment)

optional accessory driver box | ceiling plate for remote driver (more specification at p.58-59)

customizations find customizable features on p.60-61

IP40

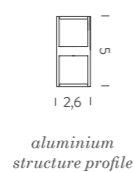
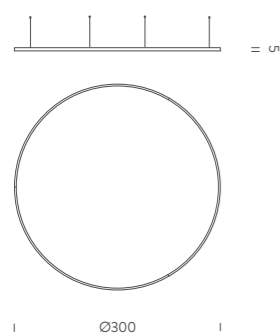
aluminium
structure profile**downlight**

- power input
- metal cable
- arch junction

**up-downlight**

- power input
- metal cable
- arch junction

CIRCLE | 3m**DOWNLIGHT**

CCT	max power	source	voltage	lum. flux	CRI	switching	code	finish
2700K	134W	linear LED	220/240V	7820lm	90	DALI 1-100%	BZRC1630G15DBO	white
							BZRC1630G15DNE	black
							BZRC1630G15DOR	matt gold
3000K				8238lm			BZRC1630G15WBO	white
							BZRC1630G15WNE	black
							BZRC1630G15WOR	matt gold
4000K				9153lm			BZRC1630G15NBO	white
							BZRC1630G15NNE	black
							BZRC1630G15NOR	matt gold

note remote driver | RAL 9005 black | RAL 9016 white | shipped in 3 pieces

included 1 x driver WALIM150W24VIN | 1 x dimmer interface WDIMDALIHP | 1 x electrical cable 5m | 6 x adjustable metal cables length 3m (including ceiling attachment)

optional accessory driver box | ceiling plate for remote driver (more specification at p.58-59)

customizations find customizable features on p.60-61

◆ IP40

UP-DOWNLIGHT

CCT	max power	source	voltage	lum. flux	CRI	switching	code	finish
2700K	268W	linear LED	110/240V	15640lm	90	DALI 1-100%	BZRC1730G15DBO	white
							BZRC1730G15DNE	black
							BZRC1730G15DOR	matt gold
3000K				16476lm			BZRC1730G15WBO	white
							BZRC1730G15WNE	black
							BZRC1730G15WOR	matt gold
4000K				18306lm			BZRC1730G15NBO	white
							BZRC1730G15NNE	black
							BZRC1730G15NOR	matt gold

note remote driver | RAL 9005 black | RAL 9016 white | shipped in 3 pieces

included 3 x drivers WALIMLED100/24 | 3 x dimmer interface WDIMDALIHP | 3 x electrical cables 5m | 6 x adjustable metal cables length 3m (including ceiling attachment)

optional accessory driver box | ceiling plate for remote driver (more specification at p.58-59)

customizations find customizable features on p.60-61

◆ IP40

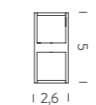
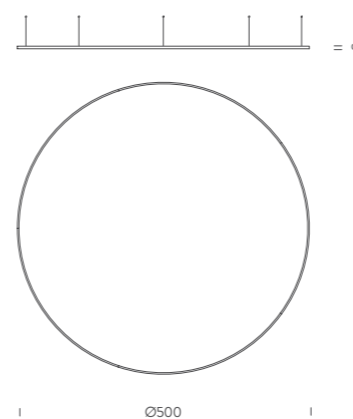
aluminium
structure profile**downlight**

- power input
- metal cable
- split

**up-downlight**

- power input
- metal cable
- split

CIRCLE | 5m**DOWNLIGHT**

CCT	max power	source	voltage	lum. flux	CRI	switching	code	finish
2700K	226W	linear LED	220/240V	13100lm	90	DALI 1-100%	BZRC1650G15DBO	white
							BZRC1650G15DNE	black
							BZRC1650G15DOR	matt gold
3000K				13847lm			BZRC1650G15WBO	white
							BZRC1650G15WNE	black
							BZRC1650G15WOR	matt gold
4000K				15386lm			BZRC1650G15NBO	white
							BZRC1650G15NNE	black
							BZRC1650G15NOR	matt gold

note remote driver | RAL 9005 black | RAL 9016 white | shipped in 5 pieces

included 1 x driver WALIM250W24VIN | 1 x dimmer interface WDIMDALIHP | 2 x electrical cables 5m | 10 x adjustable metal cables length 3m (including ceiling attachment)

optional accessory driver box | ceiling plate for remote driver (more specification at p.58-59)

customizations find customizable features on p.60-61

◆ IP40

UP-DOWNLIGHT

CCT	max power	source	voltage	lum. flux	CRI	switching	code	finish
2700K	452W	linear LED	220/240V	26100lm	90	DALI 1-100%	BZRC1750G15DBO	white
							BZRC1750G15DNE	black
							BZRC1750G15DOR	matt gold
3000K				27695lm			BZRC1750G15WBO	white
							BZRC1750G15WNE	black
							BZRC1750G15WOR	matt gold
4000K				30772lm			BZRC1750G15NBO	white
							BZRC1750G15NNE	black
							BZRC1750G15NOR	matt gold

note remote driver | RAL 9005 black | RAL 9016 white | shipped in 5 pieces

included 5 x driver WALIM120W24VIN | 5 x dimmer interface WDIMDALIHP | 5 x electrical cables 5m | 10 x adjustable metal cables 3m (including ceiling attachment)

optional accessory driver box | ceiling plate for remote driver (more specification at p.58-59)

customizations find customizable features on p.60-61

◆ IP40

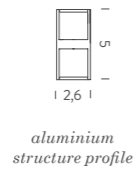
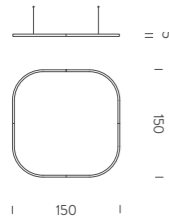

aluminium
structure profile



downlight/up-downlight

- power input
- metal cable
- split

SQUARE | 1,5 x 1,5m

DOWNLIGHT

CCT	max power	source	voltage	lum. flux	CRI	switching	code	finish
2700K	77W	linear LED	110/240V	4432lm	90	DALI 1-100%	BZRQ1606G15DBO	white
							BZRQ1606G15DNE	black
							BZRQ1606G15DOR	matt gold
3000K				4692lm			BZRQ1606G15WBO	white
							BZRQ1606G15WNE	black
							BZRQ1606G15WOR	matt gold
4000K				5214lm			BZRQ1606G15NBO	white
							BZRQ1606G15NNE	black
							BZRQ1606G15NOR	matt gold

note remote driver | RAL 9005 black | RAL 9016 white | shipped assembled

included 1 x driver WALIMLED100/24 | 1 x dimmer interface WDIMDALIHP | 1 x electrical cable 5m | 4 x adjustable metal cables length 3m (including ceiling attachment)

optional accessory driver box | ceiling plate for remote driver (more specification at p.58-59)

customizations find customizable features on p.60-61

◆ IP40

UP-DOWNLIGHT

CCT	max power	source	voltage	lum. flux	CRI	switching	code	finish
2700K	154W	linear LED	220/240V	8863lm	90	DALI 1-100%	BZRQ1712G15DBO	white
							BZRQ1712G15DNE	black
							BZRQ1712G15DOR	matt gold
3000K				9384lm			BZRQ1712G15WBO	white
							BZRQ1712G15WNE	black
							BZRQ1712G15WOR	matt gold
4000K				10427lm			BZRQ1712G15NBO	white
							BZRQ1712G15NNE	black
							BZRQ1712G15NOR	matt gold

note remote driver | RAL 9005 black | RAL 9016 white | shipped assembled

included 1 x driver WALIM250W24VIN | 1 x dimmer interface WDIMDALIHP | 1 x electrical cable 5m | 4 x adjustable metal cables length 3m (including ceiling attachment)

optional accessory driver box | ceiling plate for remote driver (more specification at p.58-59)

customizations find customizable features on p.60-61

◆ IP40



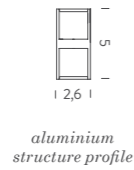
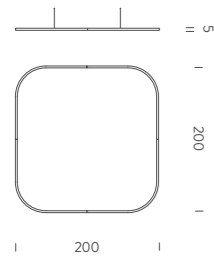

aluminium structure profile



downlight

- power input
- metal cable
- split



up-downlight

- power input
- metal cable
- split

SQUARE | 2 x 2m

DOWNLIGHT

CCT	max power	source	voltage	lum. flux	CRI	switching	code	finish
2700K	105W	linear LED	220/240V	6098lm	90	DALI 1-100%	BZRQ1608G15DBO	white
							BZRQ1608G15DNE	black
							BZRQ1608G15DOR	matt gold
3000K				6456lm			BZRQ1608G15WBO	white
							BZRQ1608G15WNE	black
							BZRQ1608G15WOR	matt gold
4000K				7174lm			BZRQ1608G15NBO	white
							BZRQ1608G15NNE	black
							BZRQ1608G15NOR	matt gold

note remote driver | RAL 9005 black | RAL 9016 white | shipped in 2 pieces

included 1 x driver WALIM150W24VIN | 1 x dimmer interface WDIMDALIHP | 1 x electrical cable 5m | 4 x adjustable metal cables length 3m (including ceiling attachment)

optional accessory driver box | ceiling plate for remote driver (more specification at p.58-59)

customizations find customizable features on p.60-61

◆ IP40

UP-DOWNLIGHT

CCT	max power	source	voltage	lum. flux	CRI	switching	code	finish
2700K	211W	linear LED	220/240V	12195lm	90	DALI 1-100%	BZRQ1716G15DBO	white
							BZRQ1716G15DNE	black
							BZRQ1716G15DOR	matt gold
3000K				12912lm			BZRQ1716G15WBO	white
							BZRQ1716G15WNE	black
							BZRQ1716G15WOR	matt gold
4000K				14347lm			BZRQ1716G15NBO	white
							BZRQ1716G15NNE	black
							BZRQ1716G15NOR	matt gold

note remote driver | RAL 9005 black | RAL 9016 white | shipped in 2 pieces

included 1 x driver WALIM250W24VIN | 1 x dimmer interface WDIMDALIHP | 2 x electrical cables 5m | 4 x adjustable metal cables length 3m (including ceiling attachment)

optional accessory driver box | ceiling plate for remote driver (more specification at p.58-59)

customizations find customizable features on p.60-61

◆ IP40

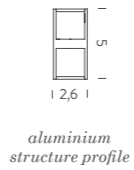
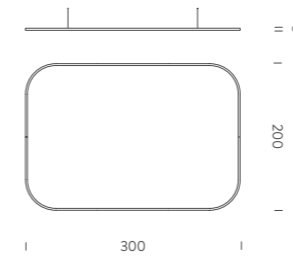

aluminium structure profile

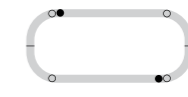

downlight/up-downlight

- power input
- metal cable
- split

SQUARE | 3 x 2m

DOWNLIGHT

CCT	max power	source	voltage	lum. flux	CRI	switching	code	finish
2700K	134W	linear LED	220/240V	7764lm	90	DALI 1-100%	BZRQ1610G15DBO	white
							BZRQ1610G15DNE	black
							BZRQ1610G15DOR	matt gold
3000K				8220lm			BZRQ1610G15WBO	white
							BZRQ1610G15WNE	black
							BZRQ1610G15WOR	matt gold
4000K				9134lm			BZRQ1610G15NBO	white
							BZRQ1610G15NNE	black
							BZRQ1610G15NOR	matt gold

note remote driver | RAL 9005 black | RAL 9016 white | shipped in 2 pieces

included 1 x driver WALIM150W24VIN | 1 x dimmer interface WDIMDALIHP | 2 x electrical cables 5m | 4 x adjustable metal cables length 3m (including ceiling attachment)

optional accessory driver box | ceiling plate for remote driver (more specification at p.58-59)

customizations find customizable features on p.60-61

◆ IP40

UP-DOWNLIGHT

CCT	max power	source	voltage	lum. flux	CRI	switching	code	finish
2700K	268W	linear LED	220/240V	15527lm	90	DALI 1-100%	BZRQ1720G15DBO	white
							BZRQ1720G15DNE	black
							BZRQ1720G15DOR	matt gold
3000K				16440lm			BZRQ1720G15WBO	white
							BZRQ1720G15WNE	black
							BZRQ1720G15WOR	matt gold
4000K				18267lm			BZRQ1720G15NBO	white
							BZRQ1720G15NNE	black
							BZRQ1720G15NOR	matt gold

note remote driver | RAL 9005 black | RAL 9016 white | shipped in 2 pieces

included 2 x drivers WALIM150W24VIN | 2 x dimmer interface WDIMDALIHP | 2 x electrical cables 5m | 4 x adjustable metal cables length 3m (including ceiling attachment)

optional accessory driver box | ceiling plate for remote driver (more specification at p.58-59)

customizations find customizable features on p.60-61

◆ IP40

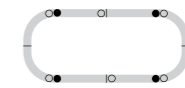
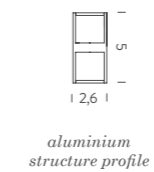
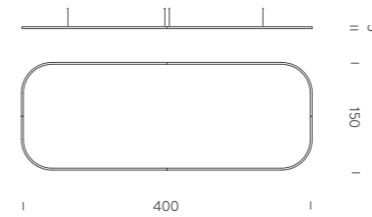

- downlight/up-downlight
- power input
 - metal cable
 - split

aluminium structure profile

SQUARE | 4 x 1,5m

DOWNLIGHT

CCT	max power	source	voltage	lum. flux	CRI	switching	code	finish
2700K	149W	linear LED	220/240V	8597lm	90	DALI 1-100%	BZRQ1611G15DBO	white
							BZRQ1611G15DNE	black
							BZRQ1611G15DOR	matt gold
3000K				9102lm			BZRQ1611G15WBO	white
							BZRQ1611G15WNE	black
							BZRQ1611G15WOR	matt gold
4000K				10114lm			BZRQ1611G15NBO	white
							BZRQ1611G15NNE	black
							BZRQ1611G15NOR	matt gold

note remote driver | RAL 9005 black | RAL 9016 white | shipped in 4 pieces

included 1 x driver WALIM150W24VIN | 1 x dimmer interface WDIMDALIHP | 4 x electrical cables 5m | 6 x adjustable metal cables length 3m (including ceiling attachment)

optional accessory driver box | ceiling plate for remote driver (more specification at p.58-59)

customizations find customizable features on p.60-61

IP40

UP-DOWNLIGHT

CCT	max power	source	voltage	lum. flux	CRI	switching	code	finish
2700K	297W	linear LED	220/240V	17193lm	90	DALI 1-100%	BZRQ1722G15DBO	white
							BZRQ1722G15DNE	black
							BZRQ1722G15DOR	matt gold
3000K				18204lm			BZRQ1722G15WBO	white
							BZRQ1722G15WNE	black
							BZRQ1722G15WOR	matt gold
4000K				20227lm			BZRQ1722G15NBO	white
							BZRQ1722G15NNE	black
							BZRQ1722G15NOR	matt gold

note remote driver | RAL 9005 black | RAL 9016 white | shipped in 4 pieces

included 2 x drivers WALIM150W24VIN | 2 x dimmer interface WDIMDALIHP | 4 x electrical cables 5m | 4 x adjustable metal cables length 3m (including ceiling attachment)

optional accessory driver box | ceiling plate for remote driver (more specification at p.58-59)

customizations find customizable features on p.60-61

IP40

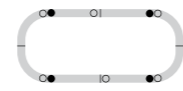
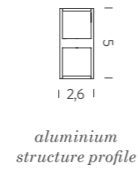
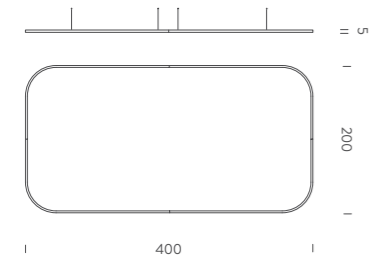

- downlight/up-downlight*
- power input
 - metal cable
 - split

SQUARE | 4 x 2m

DOWNLIGHT

CCT	max power	source	voltage	lum. flux	CRI	switching	code	finish
2700K	163W	linear LED	220/240V	9430lm	90	DALI 1-100%	BZRQ1612G15DBO	white
							BZRQ1612G15DNE	black
							BZRQ1612G15DOR	matt gold
3000K				9984lm			BZRQ1612G15WBO	white
							BZRQ1612G15WNE	black
							BZRQ1612G15WOR	matt gold
4000K				11094lm			BZRQ1612G15NBO	white
							BZRQ1612G15NNE	black
							BZRQ1612G15NOR	matt gold

note remote driver | RAL 9005 black | RAL 9016 white | shipped in 4 pieces

included 1 x driver WALIM250W24VIN | 1 x dimmer interface WDIMDALIHP | 4 x electrical cables 5m | 6 x adjustable metal cables length 3m (including ceiling attachment)

optional accessory driver box | ceiling plate for remote driver (more specification at p.58-59)

customizations find customizable features on p.60-61

◆ IP40

UP-DOWNLIGHT

CCT	max power	source	voltage	lum. flux	CRI	switching	code	finish
2700K	326W	linear LED	220/240V	18859lm	90	DALI 1-100%	BZRQ1724G15DBO	white
							BZRQ1724G15DNE	black
							BZRQ1724G15DOR	matt gold
3000K				19968lm			BZRQ1724G15WBO	white
							BZRQ1724G15WNE	black
							BZRQ1724G15WOR	matt gold
4000K				22187lm			BZRQ1724G15NBO	white
							BZRQ1724G15NNE	black
							BZRQ1724G15NOR	matt gold

note remote driver | RAL 9005 black | RAL 9016 white | shipped in 4 pieces

included 2 x driver WALIM250W24VIN | 2 x dimmer interface WDIMDALIHP | 4 x electrical cables length 5m | 6 x adjustable metal cables length 3m (including ceiling attachment)

optional accessory driver box | ceiling plate for remote driver (more specification at p.58-59)

customizations find customizable features on p.60-61

◆ IP40

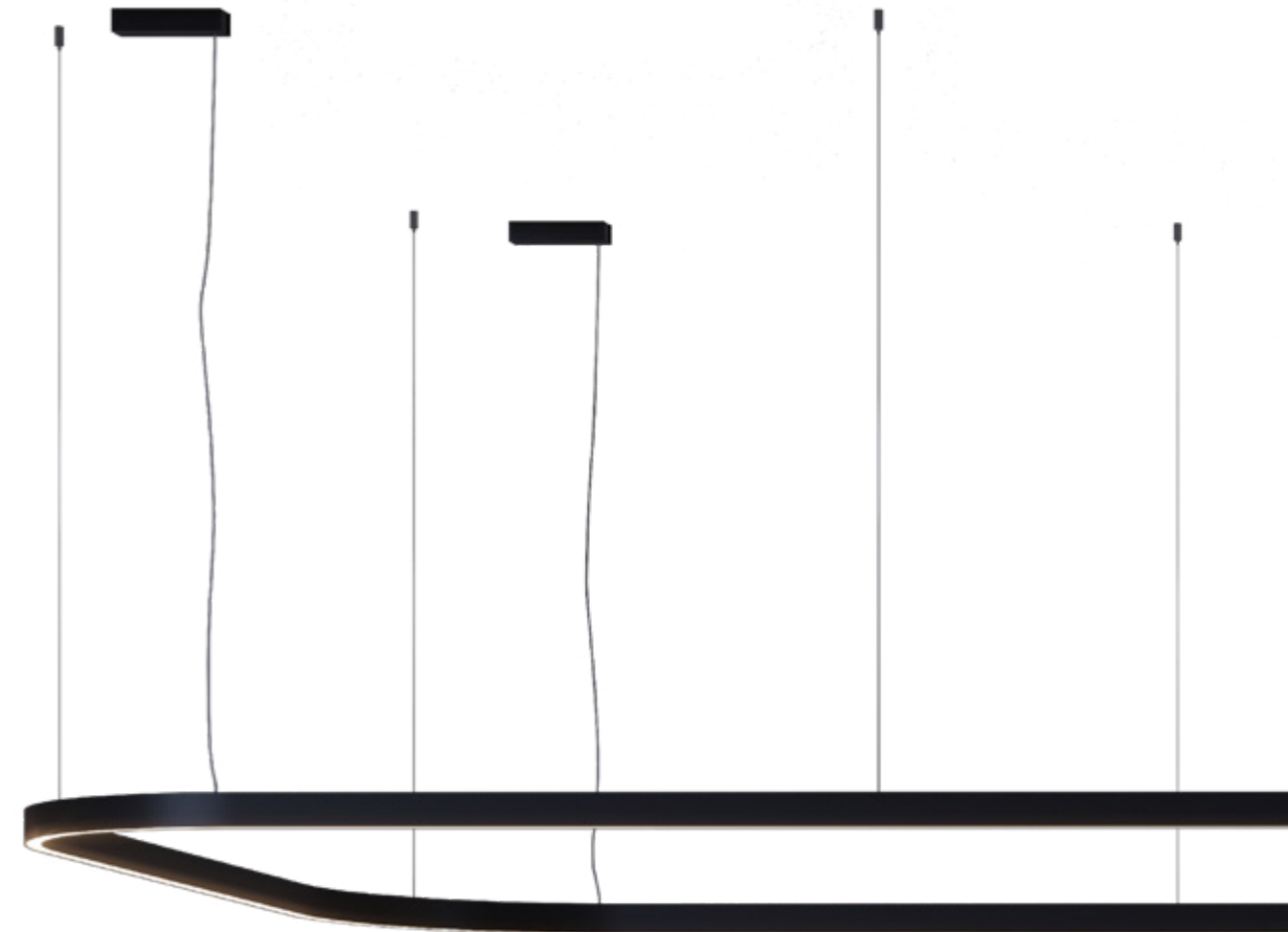

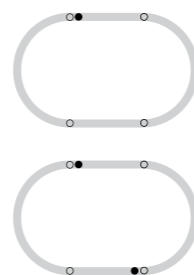
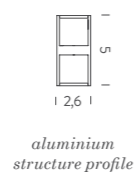
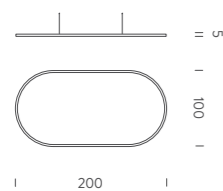

**downlight**

- power input
- metal cable

up-downlight

- power input
- metal cable

OVAL | 2 x 1m**DOWNLIGHT**

CCT	max power	source	voltage	lum. flux	CRI	switching	code	finish
2700K	74W	linear LED	100/240V	4282lm	90	DALI 1-100%	BZRO16A20G15DBO	white
							BZRO16A20G15DNE	black
							BZRO16A20G15DOR	matt gold
3000K				4533lm			BZRO16A20G15WBO	white
							BZRO16A20G15WNE	black
							BZRO16A20G15WOR	matt gold
4000K				5037lm			BZRO16A20G15NBO	white
							BZRO16A20G15NNE	black
							BZRO16A20G15NOR	matt gold

note remote driver | RAL 9005 black | RAL 9016 white | shipped assembled

included 1 x driver WALIMLED100/24 | 1 x dimmer interface WDIMDALIHP | 1 x electrical cable 5m | 4 x adjustable metal cables length 3m (including ceiling attachment)

optional accessory driver box | ceiling plate for remote driver (more specification at p.58-59)

customizations find customizable features on p.60-61

◆ IP40

UP-DOWNLIGHT

CCT	max power	source	voltage	lum. flux	CRI	switching	code	finish
2700K	148W	linear LED	220/240V	8563lm	90	DALI 1-100%	BZRO17A20G15DBO	white
							BZRO17A20G15DNE	black
							BZRO17A20G15DOR	matt gold
3000K				9067lm			BZRO17A20G15WBO	white
							BZRO17A20G15WNE	black
							BZRO17A20G15WOR	matt gold
4000K				10074lm			BZRO17A20G15NBO	white
							BZRO17A20G15NNE	black
							BZRO17A20G15NOR	matt gold

note remote driver | RAL 9005 black | RAL 9016 white | shipped assembled

included 1 x driver WALIM150W24VIN | 1 x dimmer interface WDIMDALIHP | 2 x electrical cables 5m | 4 x adjustable metal cables length 3m (including ceiling attachment)

optional accessory driver box | ceiling plate for remote driver (more specification at p.58-59)

customizations find customizable features on p.60-61

◆ IP40

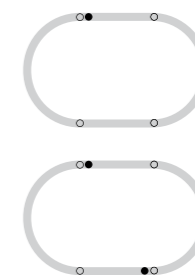
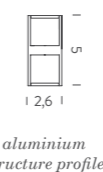
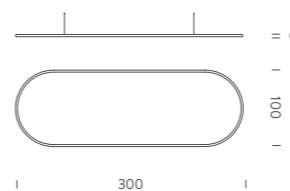
**downlight**

- power input
- metal cable

up-downlight

- power input
- metal cable

OVAL | 3 x 1m**DOWNLIGHT**

CCT	max power	source	voltage	lum. flux	CRI	switching	code	finish
2700K	103W	linear LED	220/240V	5948lm	90	DALI 1-100%	BZRO16A30G15DBO	white
							BZRO16A30G15DNE	black
							BZRO16A30G15DOR	matt gold
3000K				6297lm			BZRO16A30G15WBO	white
							BZRO16A30G15WNE	black
							BZRO16A30G15WOR	matt gold
4000K				6997lm			BZRO16A30G15NBO	white
							BZRO16A30G15NNE	black
							BZRO16A30G15NOR	matt gold

note remote driver | RAL 9005 black | RAL 9016 white | shipped assembled

included 1 x driver WALIM150W24VIN | 1 x dimmer interface WDIMDALIHP | 1 x electrical cable 5m | 4 x adjustable metal cables length 3m (including ceiling attachment)

optional accessory driver box | ceiling plate for remote driver (more specification at p.58-59)

customizations find customizable features on p.60-61

◆ IP40

UP-DOWNLIGHT

CCT	max power	source	voltage	lum. flux	CRI	switching	code	finish
2700K	206W	linear LED	220/240V	11895lm	90	DALI 1-100%	BZRO17A30G15DBO	white
							BZRO17A30G15DNE	black
							BZRO17A30G15DOR	matt gold
3000K				12595lm			BZRO17A30G15WBO	white
							BZRO17A30G15WNE	black
							BZRO17A30G15WOR	matt gold
4000K				13994lm			BZRO17A30G15NBO	white
							BZRO17A30G15NNE	black
							BZRO17A30G15NOR	matt gold

note remote driver | RAL 9005 black | RAL 9016 white | shipped assembled

included 1 x driver WALIM250W24VIN | 1 x dimmer interface WDIMDALIHP | 2 x electrical cables 5m | 4 x adjustable metal cables length 3m (including ceiling attachment)

optional accessory driver box | ceiling plate for remote driver (more specification at p.58-59)

customizations find customizable features on p.60-61

◆ IP40

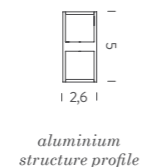
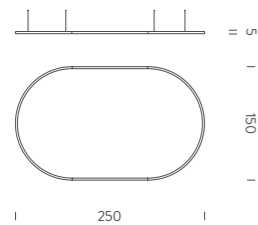
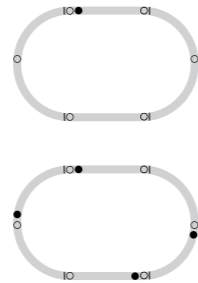
aluminium
structure profile*downlight*

- power input
- metal cable
- split

up-downlight

- power input
- metal cable
- split

OVAL | 2,5 x 1,5m**DOWNLIGHT**

CCT	max power	source	voltage	lum. flux	CRI	switching	code	finish
2700K	97W	linear LED	220/240V	5589lm	90	DALI 1-100%	BZRO16B25G15DBO	white
							BZRO16B25G15DNE	black
							BZRO16B25G15DOR	matt gold
3000K				5918lm			BZRO16B25G15WBO	white
							BZRO16B25G15WNE	black
							BZRO16B25G15WOR	matt gold
4000K				6576lm			BZRO16B25G15NBO	white
							BZRO16B25G15NNE	black
							BZRO16B25G15NOR	matt gold

note remote driver | RAL 9005 black | RAL 9016 white | shipped in 4 pieces

included 1 x driver WALIM150W24VIN | 1 x dimmer interface WDIMDALIHP | 1 x electrical cable 5m | 6 x adjustable metal cables length 3m (including ceiling attachment)

optional accessory driver box | ceiling plate for remote driver (more specification at p.58-59)

customizations find customizable features on p.60-61

◆ IP40

UP-DOWNLIGHT

CCT	max power	source	voltage	lum. flux	CRI	switching	code	finish
2700K	193W	linear LED	220/240V	11179lm	90	DALI 1-100%	BZRO17B25G15DBO	white
							BZRO17B25G15DNE	black
							BZRO17B25G15DOR	matt gold
3000K				11836lm			BZRO17B25G15WBO	white
							BZRO17B25G15WNE	black
							BZRO17B25G15WOR	matt gold
4000K				13152lm			BZRO17B25G15NBO	white
							BZRO17B25G15NNE	black
							BZRO17B25G15NOR	matt gold

note remote driver | RAL 9005 black | RAL 9016 white | shipped in 4 pieces

included 1 x driver WALIM250W24VIN | 1 x dimmer interface WDIMDALIHP | 4 x electrical cables 5m | 6 x adjustable metal cables length 3m (including ceiling attachment)

optional accessory driver box | ceiling plate for remote driver (more specification at p.58-59)

customizations find customizable features on p.60-61

◆ IP40



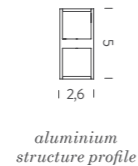
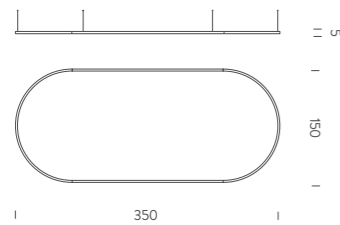

aluminium structure profile

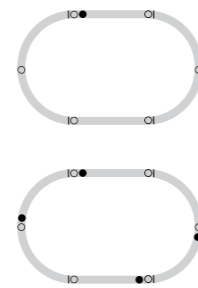
*downlight*

- power input
- metal cable
- split

up-downlight

- power input
- metal cable
- split

OVAL | 3,5 x 1,5m

DOWNLIGHT

CCT	max power	source	voltage	lum. flux	CRI	switching	code	finish
2700K	125W	linear LED	220/240V	7255lm	90	DALI 1-100%	BZRO16B35G15DBO	white
							BZRO16B35G15DNE	black
							BZRO16B35G15DOR	matt gold
3000K				7682lm			BZRO16B35G15WBO	white
							BZRO16B35G15WNE	black
							BZRO16B35G15WOR	matt gold
4000K				8536lm			BZRO16B35G15NBO	white
							BZRO16B35G15NNE	black
							BZRO16B35G15NOR	matt gold

note remote driver | RAL 9005 black | RAL 9016 white | shipped in 4 pieces

included 1 x driver WALIM150W24VIN | 1 x dimmer interface WDIMDALIHP | 1 x electrical cable 5m | 6 x adjustable metal cables length 3m (including ceiling attachment)

optional accessory driver box | ceiling plate for remote driver (more specification at p.58-59)

customizations find customizable features on p.60-61

◆ IP40

UP-DOWNLIGHT

CCT	max power	source	voltage	lum. flux	CRI	switching	code	finish
2700K	251W	linear LED	220/240V	14511lm	90	DALI 1-100%	BZRO17B35G15DBO	white
							BZRO17B35G15DNE	black
							BZRO17B35G15DOR	matt gold
3000K				15364lm			BZRO17B35G15WBO	white
							BZRO17B35G15WNE	black
							BZRO17B35G15WOR	matt gold
4000K				17072lm			BZRO17B35G15NBO	white
							BZRO17B35G15NNE	black
							BZRO17B35G15NOR	matt gold

note remote driver | RAL 9005 black | RAL 9016 white | shipped in 4 pieces

included 2 x drivers WALIM150W24VIN | 2 x dimmer interface WDIMDALIHP | 4 x electrical cables 5m | 6 x adjustable metal cables length 3m (including ceiling attachment)

optional accessory driver box | ceiling plate for remote driver (more specification at p.58-59)

customizations find customizable features on p.60-61

◆ IP40

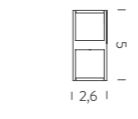
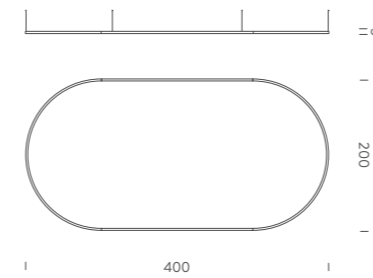

aluminium structure profile

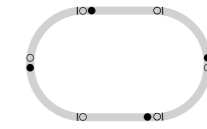
*downlight/up-downlight*

- power input
- metal cable
- split

OVAL | 4 x 2m

DOWNLIGHT

CCT	max power	source	voltage	lum. flux	CRI	switching	code	finish
2700K	148W	linear LED	220/240V	8536lm	90	DALI 1-100%	BZRO16C40G15DBO	white
							BZRO16C40G15DNE	black
							BZRO16C40G15DOR	matt gold
3000K				9067lm			BZRO16C40G15WBO	white
							BZRO16C40G15WNE	black
							BZRO16C40G15WOR	matt gold
4000K				10074lm			BZRO16C40G15NBO	white
							BZRO16C40G15NNE	black
							BZRO16C40G15NOR	matt gold

note remote driver | RAL 9005 black | RAL 9016 white | shipped in 4 pieces

included 1 x drivers WALIM250W24VIN | 1 x dimmer interface WDIMDALIHP | 4 x electrical cables 5m | 6 x adjustable metal cables length 3m (including ceiling attachment)

optional accessory driver box | ceiling plate for remote driver (more specification at p.58-59)

customizations find customizable features on p.60-61

◆ IP40

UP-DOWNLIGHT

CCT	max power	source	voltage	lum. flux	CRI	switching	code	finish
2700K	296W	linear LED	220/240V	17126lm	90	DALI 1-100%	BZRO17C40G15DBO	white
							BZRO17C40G15DNE	black
							BZRO17C40G15DOR	matt gold
3000K				18134lm			BZRO17C40G15WBO	white
							BZRO17C40G15WNE	black
							BZRO17C40G15WOR	matt gold
4000K				20149lm			BZRO17C40G15NBO	white
							BZRO17C40G15NNE	black
							BZRO17C40G15NOR	matt gold

note remote driver | RAL 9005 black | RAL 9016 white | shipped in 4 pieces

included 2 x drivers WALIM150W24VIN | 2 x dimmer interface WDIMDALIHP | 4 x electrical cables 5m | 6 x adjustable metal cables length 3m (including ceiling attachment)

optional accessory driver box | ceiling plate for remote driver (more specification at p.58-59)

customizations find customizable features on p.60-61

◆ IP40

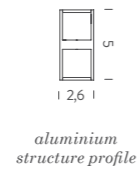
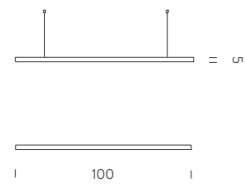

downlight/up-downlight

- power input
- metal cable

LINEAR | 1m

DOWNLIGHT

CCT	max power	source	voltage	lum. flux	CRI	switching	code	finish
2700K	14,5W	linear LED	220/240V	833lm	90	DALI 1-100%	BZRL1610G15DBO	white
							BZRL1610G15DNE	black
							BZRL1610G15DOR	matt gold
3000K				882lm			BZRL1610G15WBO	white
							BZRL1610G15WNE	black
							BZRL1610G15WOR	matt gold
4000K				980lm			BZRL1610G15NBO	white
							BZRL1610G15NNE	black
							BZRL1610G15NOR	matt gold

note remote driver | RAL 9005 black | RAL 9016 white | shipped assembled

included 1 x driver WALIMLED020/24 | 1 x dimmer interface WDIMDALIHP | 1 electrical cable length 5m | 2 x adjustable metal cables length 3m (including ceiling attachment)

optional accessory driver box | ceiling plate for remote driver (more specification at p.58-59)

customizations find customizable features on p.60-61

◆ IP40

UP-DOWNLIGHT

CCT	max power	source	voltage	lum. flux	CRI	switching	code	finish
2700K	29W	linear LED	220/240V	1666lm	90	DALI 1-100%	BZRL1710G15DBO	white
							BZRL1710G15DNE	black
							BZRL1710G15DOR	matt gold
3000K				1764lm			BZRL1710G15WBO	white
							BZRL1710G15WNE	black
							BZRL1710G15WOR	matt gold
4000K				1960lm			BZRL1710G15NBO	white
							BZRL1710G15NNE	black
							BZRL1710G15NOR	matt gold

note remote driver | RAL 9005 black | RAL 9016 white | shipped assembled

included 1 x driver WALIM60W24VIN | 1 x dimmer interface WDIMDALIHP | 1 electrical cable length 5m | 2 adjustable metal cables length 3m (including ceiling attachment)

optional accessory driver box | ceiling plate for remote driver (more specification at p.58-59)

customizations find customizable features on p.60-61

◆ IP40

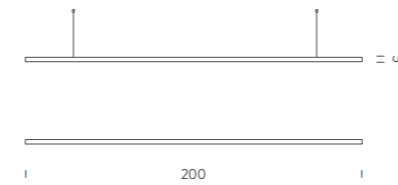

downlight/up-downlight

- power input
- metal cable

LINEAR | 2m

DOWNLIGHT

CCT	max power	source	voltage	lum. flux	CRI	switching	code	finish
2700K	29W	linear LED	220/240V	1666lm	90	DALI 1-100%	BZRL1620G15DBO	white
							BZRL1620G15DNE	black
							BZRL1620G15DOR	matt gold
3000K				1764lm			BZRL1620G15WBO	white
							BZRL1620G15WNE	black
							BZRL1620G15WOR	matt gold
4000K				1960lm			BZRL1620G15NBO	white
							BZRL1620G15NNE	black
							BZRL1620G15NOR	matt gold

note remote driver | RAL 9005 black | RAL 9016 white | shipped assembled

included 1 x driver WALIM60W24VIN | 1 x dimmer interface WDIMDALIHP | 1 electrical cable length 5m | 2 adjustable metal cables length 3m (including ceiling attachment)

optional accessory driver box | ceiling plate for remote driver (more specification at p.58-59)

customizations find customizable features on p.60-61

◆ IP40

UP-DOWNLIGHT

CCT	max power	source	voltage	lum. flux	CRI	switching	code	finish
2700K	58W	linear LED	220/240V	3332lm	90	DALI 1-100%	BZRL1720G15DBO	white
							BZRL1720G15DNE	black
							BZRL1720G15DOR	matt gold
3000K				3528lm			BZRL1720G15WBO	white
							BZRL1720G15WNE	black
							BZRL1720G15WOR	matt gold
4000K				3920lm			BZRL1720G15NBO	white
							BZRL1720G15NNE	black
							BZRL1720G15NOR	matt gold

note remote driver | RAL 9005 black | RAL 9016 white | shipped assembled

included 1 x driver WALIM60W24VIN | 1 x dimmer interface WDIMDALIHP | 1 electrical cable length 5m | 2 adjustable metal cables length 3m (including ceiling attachment)

optional accessory driver box | ceiling plate for remote driver (more specification at p.58-59)

customizations find customizable features on p.60-61

◆ IP40

ZIRKOL | LINEAR

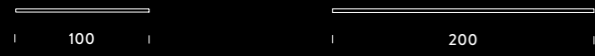

ZIRKOL | CIRCLE

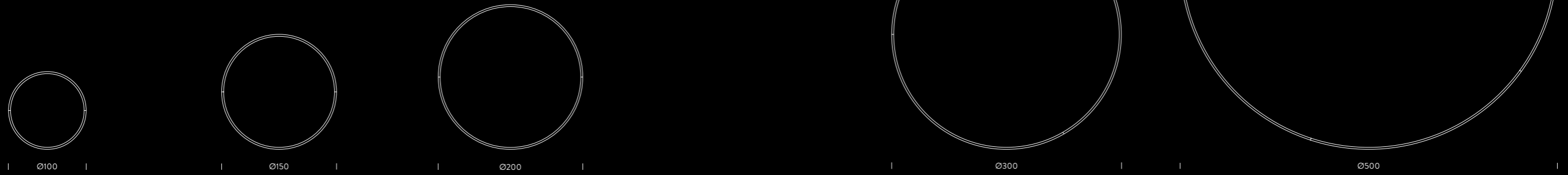

ZIRKOL | SQUARE

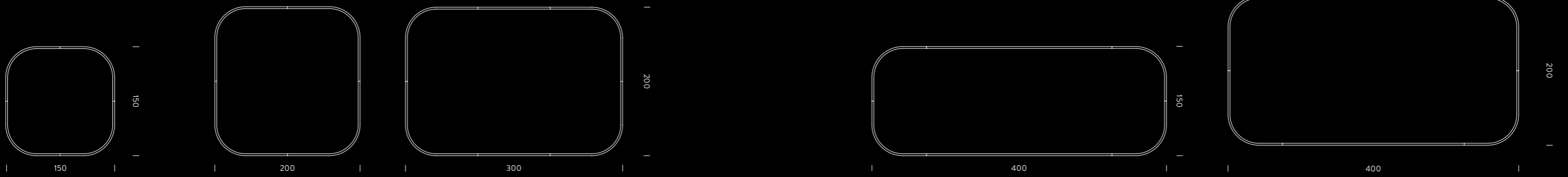

ZIRKOL | OVAL

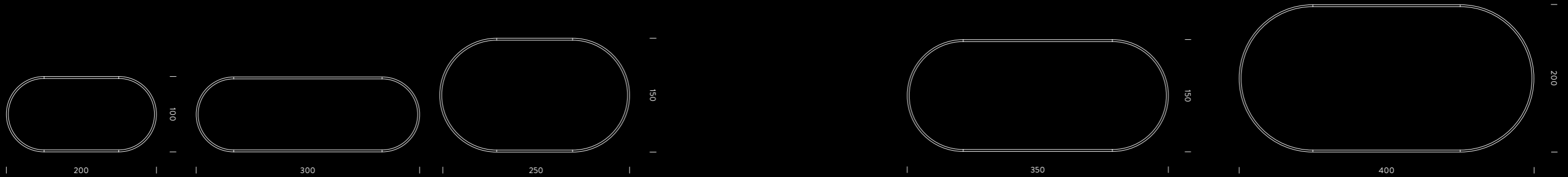

Le infinite forme di ZIRKOL possono essere create su richiesta, per soddisfare qualsiasi esigenza di progetto. Profili lineari e curvi possono essere combinati e collegati per creare una lampada dal design unico perfettamente integrata all'ambiente per cui è stata realizzata, con una determinata emissione luminosa, temperatura colore e finitura. La volontà di soddisfare ogni esigenza progettuale è propria del dinamismo di Nemo Studio che si impegna ad offrire un servizio di supporto tecnico, fornendo soluzioni ad hoc per ottenere la luce perfetta. È possibile selezionare il tipo di emissione della luce (downlight e uplight), la temperatura colore (2700-3000-4000K, tunable white, RGB o RGBW), la dimmerazione (DALI, 0-10V, 1-10V o Push) e il controllo della luce (Casambi, DMX, etc.)

Custom ZIRKOL shapes can be created on request to meet any project requirement. Linear and curved profiles can be combined to create unique bespoke luminaire designs with different types of light emission (downlight and uplight), colour temperature (2700-3000-4000K, tunable white, RGB or RGBW), dimming capabilities (DALI, 0-10V, 1-10V or Push) and additional light controls (e.g. Casambi, DMX, or other). Nemo Studio's dynamic approach is to provide tailored solutions studied to look after each individual project and provide it with the optimal lighting solution. Our in-house Lighting Advice Department offers ad hoc support, product-customization and light-planning to make sure the lighting needs are met with the perfect light.

ZIRKOL kann je nach Projekt - und Designanforderung maßgeschneidert hergestellt werden. Kombinationen aus lineare und gebogenen Profilen formen einzigartige und maßgeschneiderte Design-Leuchten. Zudem sind Lichtabstrahlung (Downlight und Uplight), Farbtemperatur (2700-3000-4000K, abstimmbares Weiß, RGB oder RGBW), Dimmmöglichkeiten (DALI, 0-10V, 1-10V oder Push) und zusätzlichen Lichtsteuerungen (z.B. Casambi, DMX oder andere) frei wählbar. Der dynamische Ansatz von Nemo Studio ist es, maßgeschneiderte Lösungen anzubieten, die für jedes einzelne Projekt speziell gefertigt werden für eine optimale Beleuchtungslösung. Unsere hauseigene Lichtberatungsabteilung (Lighting Advice Department) bietet Unterstützung bei der Produktpassung und Lichtplanung, und stellt sicher, dass Ihre Beleuchtungskonzepte mit dem perfekten Licht realisiert werden.

Les formes infinies de ZIRKOL peuvent être créées sur mesure, pour satisfaire n'importe quelles exigences du projet. Les profilés linéaires et cintrés peuvent être associés et connectés pour créer une suspension d'un design unique parfaitement intégré à l'espace pour lequel elle est réalisée, avec un flux lumineux déterminé, température de couleur et finition. La volonté de satisfaire chaque exigence est propre au dynamisme de Nemo Studio qui s'emploie à offrir un service de support technique, fournissant des solutions ad hoc pour obtenir la lumière parfaite. Il est possible de sélectionner le type d'émission de la lumière (direct et indirecte), la température de couleur (2700-3000-4000K-lumière modulable tunable white- RGB ou RGBW), la variation (DALI, 0-10V, 1-10V ou Push) et le contrôle de la lumière (Casambi, DMX etc ..)



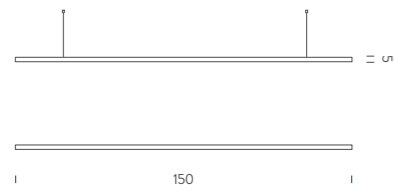

downlight

- power input
- metal cable

L1,5 | DOWNLIGHT

CCT 3000K | 22W | 1323lm

● structure black

Linear LED | diffused | typ cri 90 | DALI 1-100%

1 x canopy 1 driver - 1 x electrical cable lenght 5m | 2 x adjustable metal cables length 3m | dimmer interface | 2 x ceiling attachments | 2 x end cups

Shipped assembled

customizations: optional accessories and customizable features on p.58-61



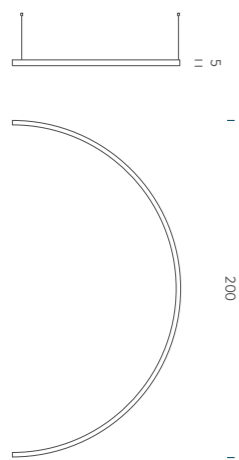

D2 | DOWNLIGHT

CCT 3000K | 45W | 2766lm

● structure black

Linear LED | diffused | typ cri 90 | DALI 1-100%

1 x ceiling plate for remote driver - 1 x electrical cable length 5m | 3 x adjustable metal cables length 3m |

1 x driver (remote) | dimmer interface | 3 x ceiling attachment | 2 x end cup

Shipped assembled

customizations: optional accessories and customizable features on p.58-61



downtlight

● power input

○ metal cable



Zirkol Custom D2

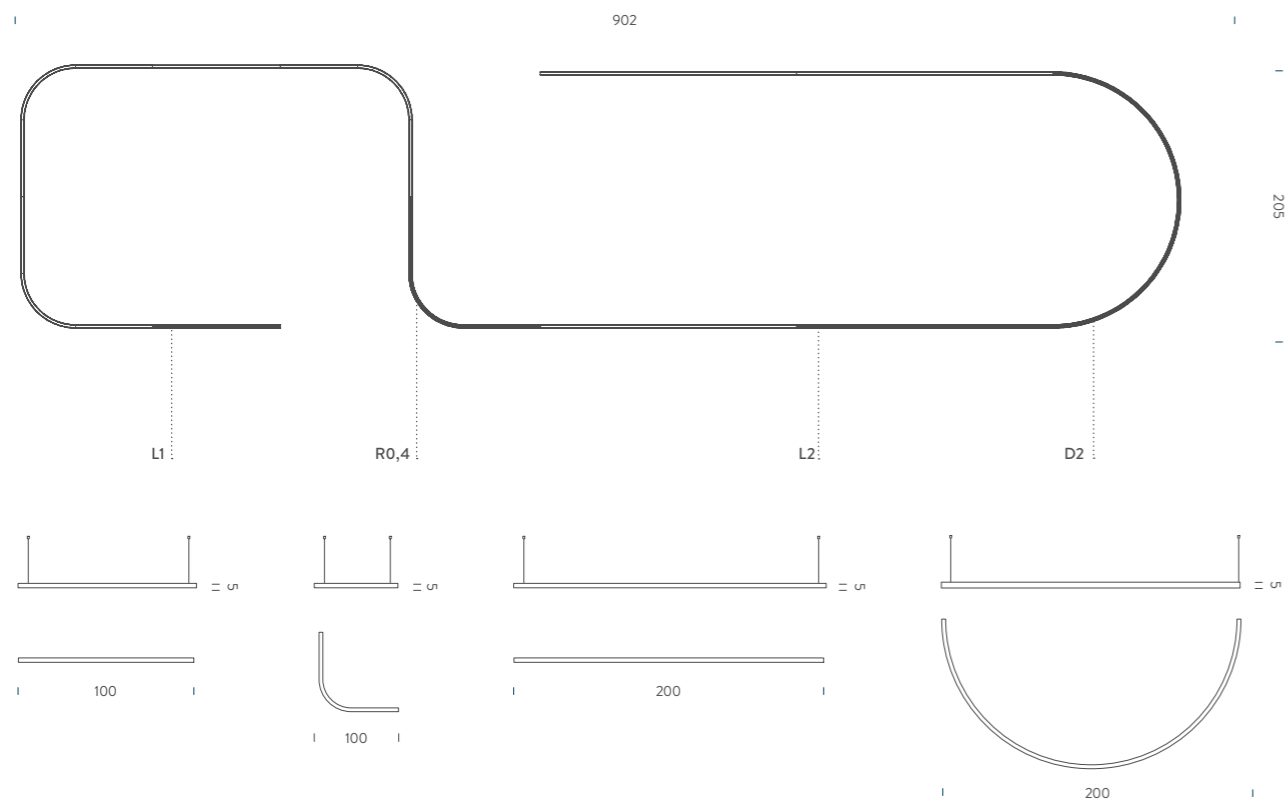

downtlight

- power input
- metal cable
- split



2xL1+4xL2+4xR0,4+D2 | DOWNLIGHT

CCT 4000K | 303W | 20904lm

● structure black

Linear LED | diffused | typ cri 90 | DALI 1-100%
 canopy 1 driver - electrical cable length 5m | adjustable metal cables length 3m | dimmer interface | ceiling attachments | end cups

customizations: optional accessories and customizable features on p.58-61

Zirkol Custom 2xL1+4xL2+4xR0,4+D2

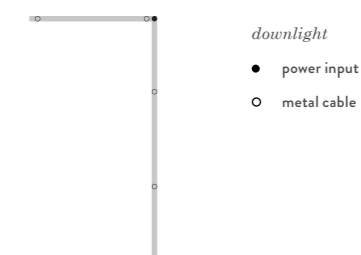
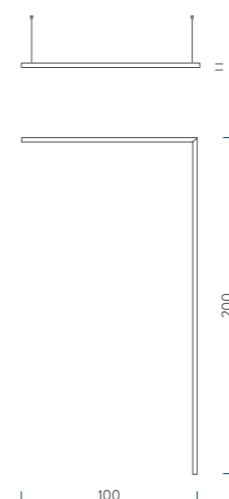

Zirkol Custom Linear Angle 90°

**LINEAR ANGLE 90° | DOWNLIGHT**

CCT 4000K | 45W | 2700lm

● structure black

Linear LED | diffused | typ cri 90 | DALI 1-100%

1 x ceiling plate for remote driver - 1 x electrical cable length 5m | 4 x adjustable metal cables length 3m |

1 x driver (remote) | dimmer interface | 3 x ceiling attachment | 2 x end cup

Shipped assembled

customizations: optional accessories and customizable features on p.58-61

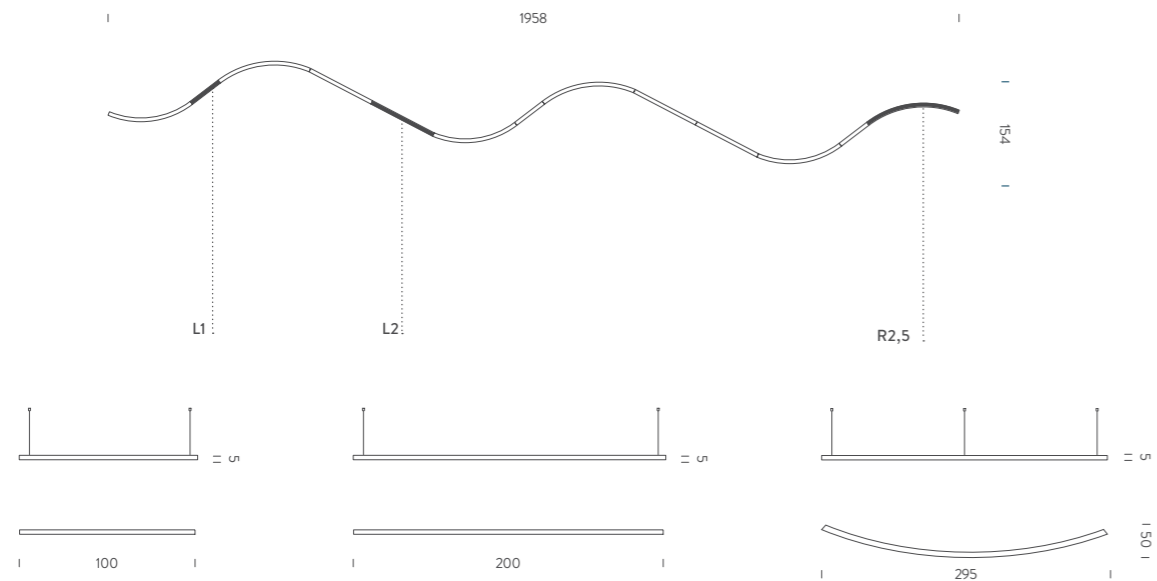

3xL1+4xL2+6xR2,5 | DOWNLIGHT

CCT 3000K | 435W | 26535lm

● structure black

Linear LED | diffused | typ cri 90 | DALI 1-100%

ceiling plate for remote driver - electrical cable length 5m | adjustable metal cables length 3m |

driver (remote) | dimmer interface | ceiling attachment | end cup

Shipped assembled

customizations: optional accessories and customizable features on p.58-61



downtlight

● power input

○ metal cable

- split



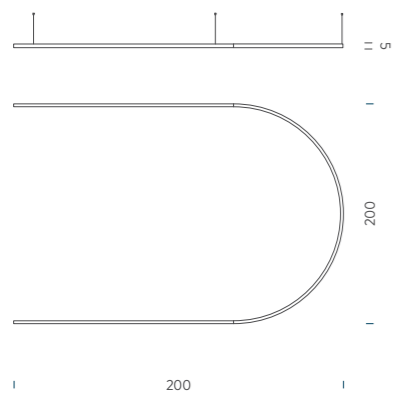

2xL2+D2 | DOWNLIGHT

CCT 2700K | 210W | 12600lm

● structure matt gold

Linear LED | diffused | typ cri 90 | DALI 1-100%
1 x canopy 1 driver - electrical cable length 5m | 5 x adjustable metal cables length 3m |
dimmer interface | 5 x ceiling attachment | 2 x end cup

customizations: optional accessories and customizable features on p.58-61

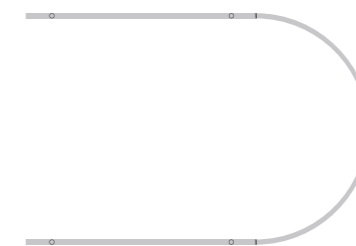

up-downlight

● power input

○ metal cable

- split



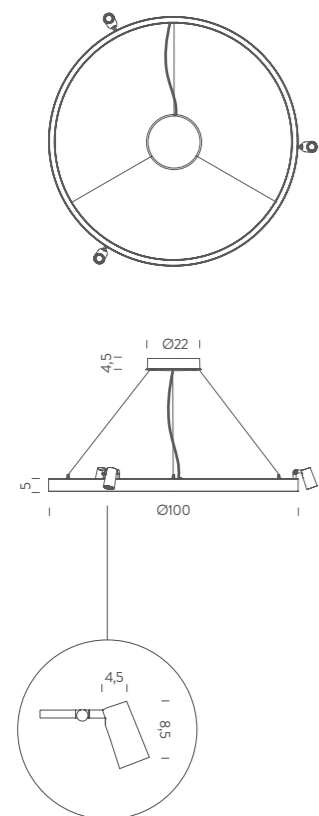

downlight
 ● power input
 ○ metal cable

ZIRKOL HOME SPOT | DOWNLIGHT

CCT 3000K | 45W Linear Led + 5W Single Spot | 2769lm + 365lm

● structure black

Linear LED + Spot | diffused + spotlight | typ cri 90 | DALI 1-100%

included: canopy with 1 x driver WALIMLED100/24 | 1 x dimmer interface WDIMDALIHP | 1 x electrical cable 4m | 3 x adjustable metal cables (length from 3m to 0,5m)

note: 3 x orientable spots in a fixed position | single switching

customizations: spot positioning | optional accessories and customizable features on p.58-61



orientable spot in a fixed position



ZIRKOL OPTIONAL ACCESSORIES

DRIVER

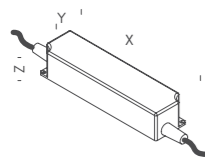

dimensions x,y,z	max power	voltage	switching	code
15x4x3	20W	24V	ON-OFF	WALIMLED020/24
18x5,2x3	60W			WALIM60W24VIN
14x6,3x3,2	100W			WALIMLED100/24
30x4x3	120W			WALIM120W24VIN
18x6,7x3,2	150W			WALIM150W24VIN
19,5x6,7x3,2	250W			WALIM250W24VIN

DIMMER INTERFACE

WIRED

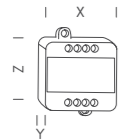

dimensions x,y,z	switching	code
4,4x1,9x5,7	0-10V 1-10V PUSH DALI	WDIMDALIHP

WIRELESS

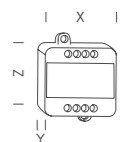

dimensions x,y,z	switching	code
4,4x1,9x5,7	CASAMBI PUSH	WBLTSMART
<i>note</i> on board (HOME version) or external mounting, iOS and Android compatible, set up by customer or by Nemo Studio on commission		

REMOTE CONTROL KIT



dimensions x,y,z	max power	voltage	switching	code
1,2x0,5x5	120W	5V - 24V	REMOTE	WDIMKITREM
<i>note</i> mono channel dimmer for LED with RF (radio frequency) wireless remote control , to be used as dimming solution in place of specific wiring				

ZIRKOL OPTIONAL ACCESSORIES

CEILING ATTACHMENT



version	finish	code
1 piece	chrome	BROSMINIST

CEILING PLATE FOR REMOTE DRIVERS

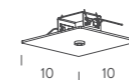
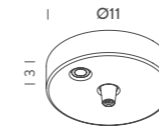

version	finish	code
surface application	white	BROSRONDBI
	black	BROSRONDBNE
	matt gold	BROSRONDBOR
recessed application	white	BROSINCBBI
	black	BROSINCBNE
	matt gold	BROSINCBOR
	white	BROSINCBBI
	black	BROSINCBNE
	matt gold	BROSINCBOR

note to be used for decentralized solutions or remote mounting driver

DRIVER BOX

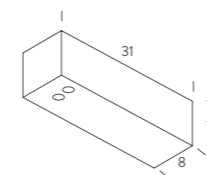
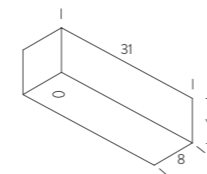

version	finish	code
1 driver-1 electrical cable	white	BROSPS1BI
	black	BROSPS1NE
	matt gold	BROSPS1OR
1 driver-2 electrical cables	white	BROSPS2BI
	black	BROSPS2NE
	matt gold	BROSPS2OR

ZIRKOL CUSTOMIZATIONS

EMISSION



CCT

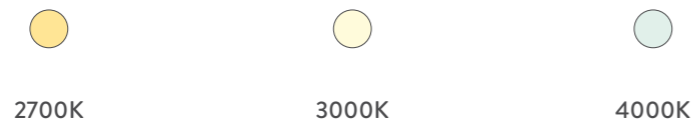

DIMMING



ZIRKOL CUSTOMIZATIONS

UGR VERSION

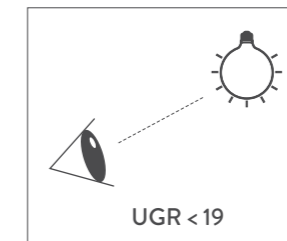

OTHER LIGHT CONFIGURATIONS



OPTIONAL CONTROLS



LINEAR

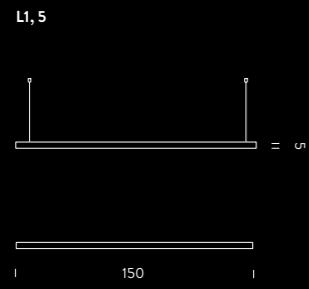

CIRCLE SPOT

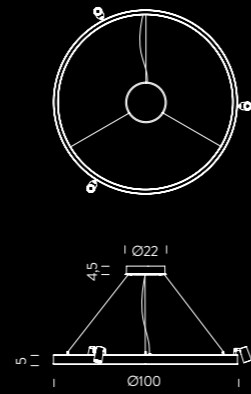

ANGLE

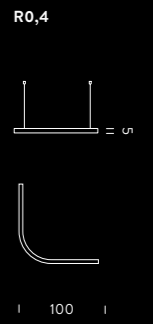
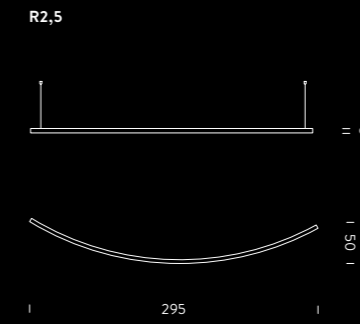
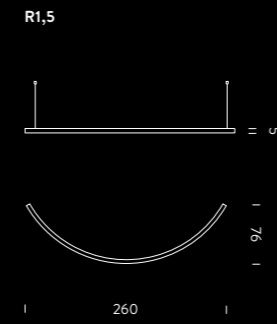

LINEAR ANGLE 90°

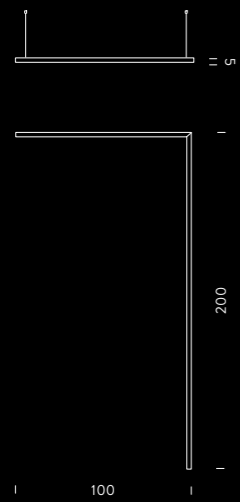

ROUND

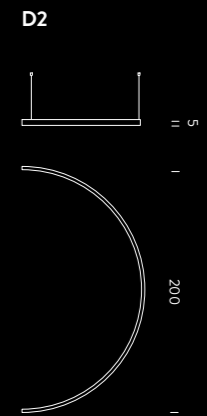
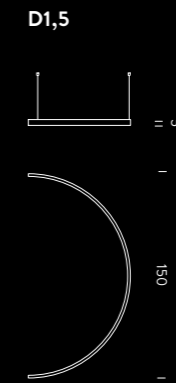



SPOTLIGHT
COLLECTION

1
VULCANO

2
ELBA

3
CAPRI



Famiglia di spots orientabili per un'illuminazione generale o d'accento in interni.

Gli apparecchi possono ruotare di 90° in verticale e di 355° in orizzontale per orientare la luce in qualsiasi direzione. Un design minimal dall'estetica compatta grazie alla struttura di dissipazione del calore e il driver integrato, rendono questa famiglia particolarmente adatta ad applicazioni nel retail. ELBA e CAPRI inoltre, sono dotati di ottica variabile con zoom on-board per soddisfare qualsiasi esigenza di illuminazione. VULCANO invece, è dotato di ottica fissa e louver modulabile antiabbagliamento. L'intera collezione è disponibile con finitura bianca e nera. Gli spots sono comprensivi di adattatore compatibile per fissaggio a binario 3-phase. ELBA e CAPRI sono proposti anche nella versione ceiling, con fissaggio a plafone.

Family of indoor spotlights for general and accent lighting.

The luminaire is rotatable by 90° vertically and 355° horizontally to allow the free orientation of the light beam. With built-in driver and integrated heat dissipation structure, the spot presents a compact solution with a minimalistic aesthetic, especially suitable for retail applications. ELBA and CAPRI are equipped with an adjustable light beam to meet any lighting requirement. VULCANO is provided with fixed optic and an adjustable anti-glare louver. The collection is available in black and white finish. The spots include a 3-phase track adaptor. ELBA and CAPRI are also available in the ceiling version, with surface mounting.

Familie von Innenraumstrahlern für die Allgemein- und Akzentbeleuchtung.

Die Spots sind um 90° vertikal und 355° horizontal orientierbar und ermöglichen die freie Ausrichtung des Lichtstrahls, je nach Bedarf. Der kompakte Spot hat einen eingebauten Treiber mit einer integrierten Wärmeableitungsstruktur, was ihn zu einem besonders-interessanten minimalistischen Strahler für Anwendungen im Einzelhandel macht. ELBA und CAPRI sind mit einer variablen Optik mit eingebautem Zoom ausgestattet, um jede Beleuchtungsanforderung zu erfüllen. VULCANO hingegen ist mit einer festen Optik und einem verstellbaren Entblendungsgitter ausgestattet. Die gesamte Kollektion ist in weißer und schwarzer Ausführung erhältlich. Die Spots enthalten einen kompatiblen Adapter für die 3-Phasen-Schienenbefestigung. ELBA und CAPRI sind auch als Aufbauspot für die direkte Anbringung an Decken erhältlich.

Famille de spots orientables pour un éclairage général ou ponctuel indoor en 230-240V. Les appareils sont orientables de 90° vertical et 355° horizontal pour une lumière multidirectionnelle. La conception intégrée - dissipateur de chaleur et driver - et l'esthétique compacte et minimale rendent cette famille particulièrement adaptée aux applications des boutiques. VULCANO a une optique fixe et un louvre anti-éblouissement. ELBA et CAPRI sont dotés chacun d'optique variable avec un zoom intégré pour un éclairage de précision. La collection est disponible en finition blanc et noir. Les spots sont pourvus d'adaptateurs compatibles pour rail tri-phasé. ELBA et CAPRI existent aussi en version plafonniers.



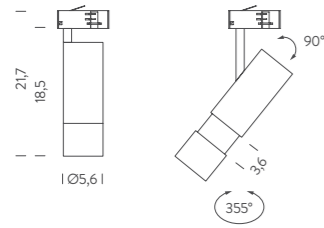

VULCANO

voltage/current	max power	source	flux	optic	CRI	switching	mounting	CCT	finish	code
220/240V	13W	LED spot	900lm	30°	>90	ON-OFF	track	3000K	white	VULLW3 82
									black	VULLN3 82

note driver on board, adjustable antiglare system, rotating body 355°, orientable spot 90°, compatible with TRACK 3~230V p.176

IP20

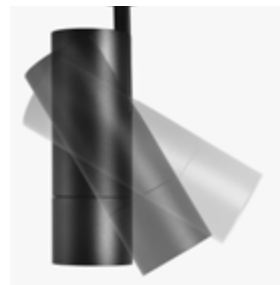

90° rotation



antiglare system

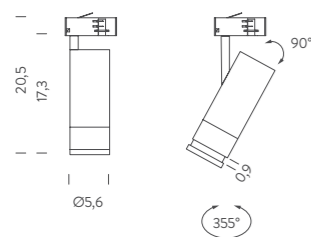

**ELBA**

voltage/current	max power	source	flux	optic	CRI	switching	mounting	CCT	finish	code
220/240V	13W	LED spot	900lm	15°/55°	>90	dimmable TRIAC	track	2700K	white	ELB LW2 81
									black	ELB LN2 81
								3000K	white	ELB LW3 81
									black	ELB LN3 81
								2700K	white	ELB LW2 82
									black	ELB LN2 82
	3000K	white	ELB LW3 82							
		black	ELB LN3 82							

note driver on board, adjustable beam 15°-55°, rotating body 355°, orientable spot 90°, compatible with TRACK 3-230V p.176

IP20

matt black finish



adjustable beam 15°-55°

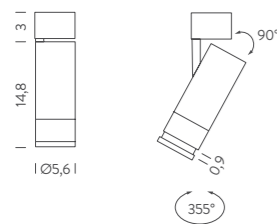

precise light distribution

**ELBA CEILING**

voltage/current	max power	source	flux	optic	CRI	switching	mounting	CCT	finish	code
220/240V	13W	LED spot	900lm	15°/55°	>90	dimmable TRIAC	track	2700K	white	ELB LW2 41
									black	ELB LN2 41
								3000K	white	ELB LW3 41
									black	ELB LN3 41
								2700K	white	ELB LW2 42
									black	ELB LN2 42
								3000K	white	ELB LW3 42
									black	ELB LN3 42

note driver on board, adjustable beam 15°-55°, rotating body 355°, orientable spot 90°

IP20

matt black finish



orientable spot



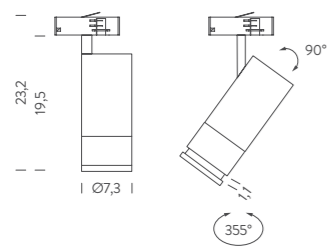

CAPRI

voltage/current	max power	source	flux	optic	CRI	switching	mounting	CCT	finish	code	
220/240V	28W	LED spot	1500lm	15°/55°	>90	dimmable TRIAC	track	2700K	white	CAP LW2 81	
									black	CAP LN2 81	
									3000K	white	CAP LW3 81
								dimmable 0-10V	2700K	black	CAP LN3 81
										white	CAP LW2 82
										black	CAP LN2 82
								3000K	white	CAP LW3 82	
									black	CAP LN3 82	
									dimmable DALI	2700K	white
								black	CAP LN2 83		
								3000K	white		CAP LW3 83

note driver on board, adjustable beam 15°-55°, rotating body 355°, orientable spot 90°, compatible with TRACK 3-230V p.176

IP20



matt black finish



precise light distribution

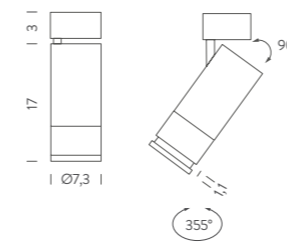

CAPRI CEILING

voltage/current	max power	source	flux	optic	CRI	switching	mounting	CCT	finish	code	
220/240V	28W	LED spot	1500lm	15°/55°	>90	dimmable TRIAC	track	2700K	white	CAP LW2 41	
									black	CAP LN2 41	
									3000K	white	CAP LW3 41
								dimmable 0-10V	2700K	black	CAP LN3 41
										white	CAP LW2 42
										black	CAP LN2 42
								3000K	white	CAP LW3 42	
									black	CAP LN3 42	
									dimmable DALI	2700K	white
								black	CAP LN2 43		
								3000K	white		CAP LW3 43

note driver on board, adjustable beam 15°-55°, rotating body 355°, orientable spot 90°

IP20



matt black finish

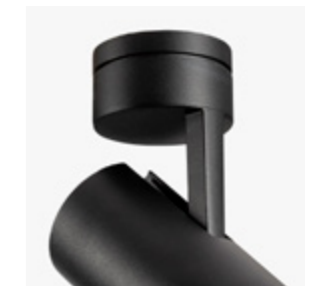

orientable spot



PLINT è uno spot a LED che irrompe nel mondo dell'illuminazione d'accento invertendone il paradigma, grazie ad un'elevata flessibilità di posizionamento.

Racchiude al suo interno design e contenuto tecnologico consentendo un'illuminazione discreta e al tempo stesso precisa. All'interno di una struttura metallica è integrato uno spot ad alte prestazioni con ottica variabile con zoom on-board, che ne permette la regolazione del fascio di luce. L'orientabilità del faretto direziona l'emissione luminosa a seconda delle specifiche necessità. PLINT è proposto con finitura nera e con due differenti temperature colore. Il dimmer on-board inoltre, permette di modulare l'illuminazione in modo puntuale.

PLINT is a LED spot that bursts into the world of accent lighting, challenging the notions of conventional spotlights with its flexibility of installation and excellent light quality. The integrated design of the high-performing spot with variable optics in a solid metal structure allow PLINT to be freely positioned for optimal and precise, yet discreet accent lighting. On-board dimming and the vast adjustability possibilities of PLINT's light emission make it a versatile and innovative tool for any project. Available in matt black finish and in two different colour temperatures.

PLINT ist ein LED-Strahler, der das Paradigma der Akzentbeleuchtung dank seiner Flexibilität in Positionierung und Anwendung auf den Kopf stellt. Das integrierte Design des leistungsstarken Spots mit einstellbarer Zoom-Optik in einer soliden Metallstruktur ermöglicht die freie Positionierung von PLINT für eine optimale und präzise, aber dennoch diskrete Akzentbeleuchtung. Die integrierte Dimmbarkeit und die umfangreichen Einstellmöglichkeiten der Lichtabstrahlung machen PLINT zu einem vielseitigen und innovativen Instrument für die Akzentbeleuchtung. Erhältlich in mattschwarzer Ausführung und in zwei verschiedenen Farbtemperaturen. Mit On-Board Dimmer.

PLINT est un spot à LED qui fait irruption dans le monde de l'éclairage ponctuel, inversant le paradigme grâce à une grande flexibilité d'implantation. Il renferme un contenu design et technologique, permettant un éclairage discret et en même temps précis. A l'intérieur d'une structure métallique est intégré un spot haute performance à optique variable avec zoom embarqué, qui permet le réglage du faisceau lumineux en fonction des besoins spécifiques.

PLINT est proposé avec une finition noire et avec deux températures de couleur différentes.

Le dimmer intégré permet également de moduler l'éclairage de façon ponctuelle.



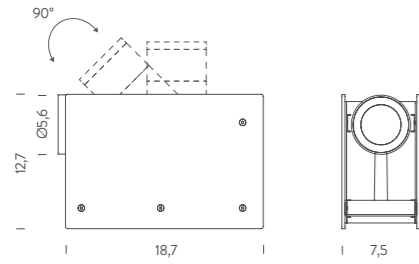

PLINT

<i>voltage/current</i>	<i>max power</i>	<i>source</i>	<i>flux</i>	<i>optic</i>	<i>CRI</i>	<i>switching</i>	<i>mounting</i>	<i>CCT</i>	<i>finish</i>	<i>code</i>
220/240V	13W	LED	900lm	direct adjustable 15°-55°	90	push dimm. on board	floor/table	2700K	black	PLT LN2 11
								3000K	black	PLT LN3 11

note driver integrated, adjustable beam 15°-55°, orientable spot 90°, cable length 3m

IP20



dimming control on board



adjustable beam 15°-55°



black finish





Plint, vertical positioning

Plint, horizontal positioning



FLEX è una famiglia di spots orientabili miniaturizzati dedicati all'illuminazione d'accento.

A seconda dell'ambiente e delle necessità di illuminazione, FLEX propone spots con fissaggio, ottiche e finiture differenti. La collezione FLEX è composta da FLEX CEILING, la gamma con ottica fissa e zoom 15° - 45°, disponibile nelle finiture nero, oro, grigio anodizzato naturale e grigio bronzo e da FLEX TRACK SYSTEM, un sistema nel quale gli spots in alluminio anodizzato nero, vengono installati a binario tramite un sistema di aggancio magnetico/meccanico. Lo snodo, presente in entrambe le versioni, consente di fissare gli spots a plafone o a binario e di orientarli a piacere, secondo le necessità di illuminazione, senza che ci siano cavi visibili all'esterno.

FLEX is a family of miniaturized adjustable spots dedicated to accent lighting.

Available in numerous fixings, optics and finishes to fulfil any installation requirement. The FLEX Collection is composed of FLEX CEILING with a fixed optic, variable beam angles and in black, gold, anodized grey and bronze grey finishes, and FLEX TRACK, a magnetic/mechanic spot system in black anodized aluminium. The integrated aluminium joint allows fixation and orientation without any visible cable.

FLEX ist eine Familie von miniaturisierten einstellbaren Strahlern für die Akzentbeleuchtung.

Je nach Projekt- und Beleuchtungsbedarf bietet die FLEX Familie mit unterschiedlichen Befestigungen, Optiken und Oberflächen an. Die FLEX-Kollektion besteht aus FLEX CEILING, der Serie mit fester Optik und 15°-45°-Zoom, die in den Ausführungen Schwarz, Gold, Natur eloxiert Grau und Bronze Grau erhältlich ist, und FLEX TRACK SYSTEM, einem System, bei dem die schwarz eloxierten Aluminiumspots mit Hilfe eines magnetisch-mechanischen Kupplungssystems auf einer Schiene installiert werden. Das in beiden Versionen vorhandene Gelenk ermöglicht die Deckenbefestigung der Strahler und die freie Ausrichtung des Lichtstrahls, je nach Beleuchtungsbedarf, ohne sichtbare Kabel.

Flex est une famille de spots miniaturisés orientables 24V pour l'éclairage ponctuel. FLEX propose des spots avec fixations, optiques et finitions diverses. La collection FLEX est composé de FLEX CEILING, la gamme avec optique fixe et zoom 15-45°, disponible dans les finitions noir, doré, gris anodisé naturel et gris bronze, de FLEX TRACK SYSTEM, un système de spots en aluminium anodisé noir sur rail avec fixation magnétique/mécanique. L'articulation, présente sur toutes les versions, permet de fixer les spots au plafond ou sur rail et de les orienter selon les exigences de l'éclairage, sans câbles apparents.

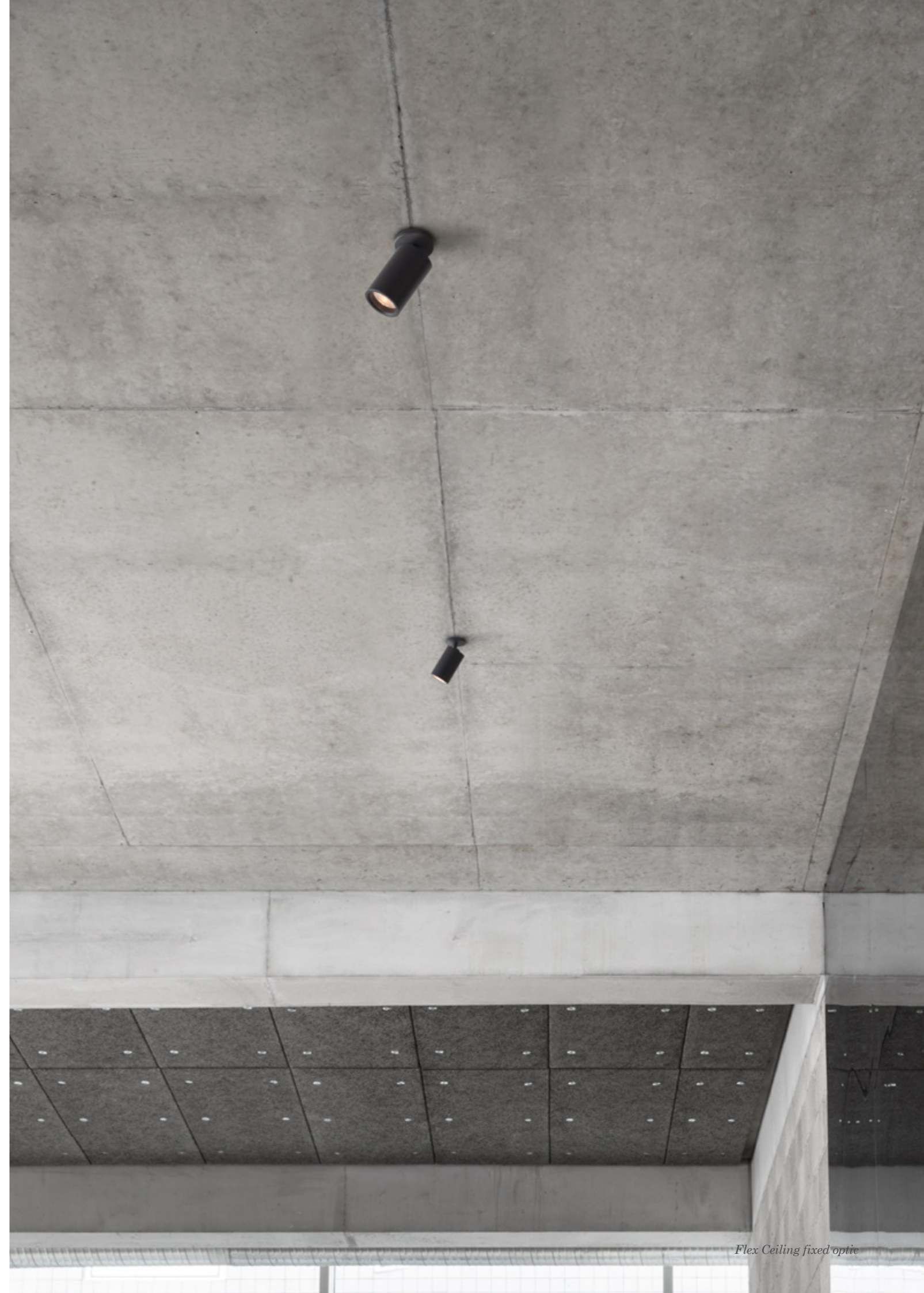

FIXED OPTIC

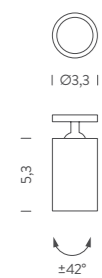

ZOOM OPTIC

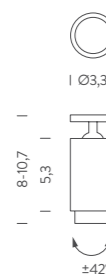

FLEX CEILING

FIXED OPTIC

voltage/current	max power	source	flux	optic	CRI	switching	mounting	CCT	finish	code	
350mA	4,2W	LED spot	362lm	20°	90	according to driver	wall-ceiling	3000K	black	BFLE0401F21WAN	
			323lm	30°						BFLE0401421WAN	
			362lm	20°						4000K	BFLE0401F21NAN
			323lm	30°						BFLE0401421NAN	
			362lm	20°				3000K	gold	BFLE0401F21WAO	
			323lm	30°				BFLE0401421WAO			
			362lm	20°				4000K	BFLE0401F21NAO		
			323lm	30°				BFLE0401421NAO			
			362lm	20°				3000K	grey	BFLE0401F21WAA	
			323lm	30°				BFLE0401421WAA			
			362lm	20°				4000K	BFLE0401F21NAA		
			323lm	30°				BFLE0401421NAA			
			362lm	20°				3000K	bronze grey	BFLE0401F21WAB	
			323lm	30°				BFLE0401421WAB			
			362lm	20°				4000K	BFLE0401F21NAB		
			323lm	30°				BFLE0401421NAB			

ZOOM OPTIC

350mA	4,2W	76lm (45°)	15°-45°	90	3000K	black	BFLE0401921WAN
		80lm (45°)	4000K		BFLE0401921NAN		

note driver not included (more specifications on p.92), orientable spot ±42°, orientable spot on ball joint 360°, series connection

customizations 1-10V, DALI, DMX, Casambi, CCT 2700K

IP40



black finish



grey finish



bronze grey finish



gold finish





FLEX CEILING DRIVER

FIXED OPTIC

<i>version</i>	<i>voltage/current</i>	<i>max power</i>	<i>switching</i>	<i>dimensions cm</i>	<i>code</i>
for 1-2 spots	350mA	12W	ON-OFF	9,8x3,3x2,2	WALIMLED08350
for 3 spots		17W		12,2x3,8x2,4	WALIMLED12350
		15W	dimnable 1-10V	10,3x6,7x2,1	WALI/DIMM/JOLLY
for 5 spots		25W		12,4x7,9x2,2	WALI/MAXI/JOLLY
<i>note</i>	series connection				

ZOOM OPTIC

<i>version</i>	<i>voltage/current</i>	<i>max power</i>	<i>switching</i>	<i>dimensions cm</i>	<i>code</i>
for 1-2 spots	350mA	12W	ON-OFF	9,8x3,3x2,2	WALIMLED08350
for 3 spots		17W		12,2x3,8x2,4	WALIMLED12350
		15W	dimnable 1-10V	10,3x6,7x2,1	WALI/DIMM/JOLLY
for 5 spots		25W		12,4x7,9x2,2	WALI/MAXI/JOLLY
<i>note</i>	series connection				



Flex Ceiling fixed optic, gold finish





FIXED OPTIC

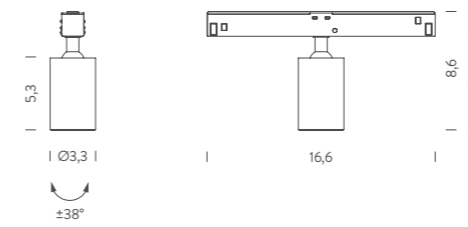

ZOOM OPTIC

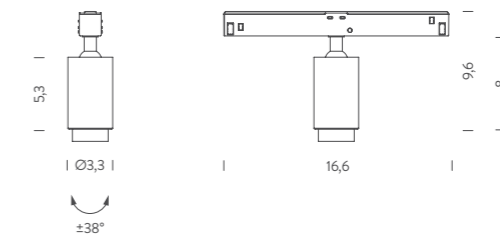

FLEX TRACK

FIXED OPTIC

voltage/current	max power	source	flux	optic	CRI	switching	mounting	CCT	finish	code
24VDC	5W	LED spot	362lm	20°	90	according to driver	track	3000K	black	MFLE5101N21WAN
			323lm	30°						MFLE5101421WAN
			362lm	20°	4000K			MFLE5101N21NAN		
			323lm	30°				MFLE5101421NAN		

ZOOM OPTIC

24VDC	76lm (45°)	15° - 45°	90	3000K	black	MFLE5101921WAN
	80lm (45°)	4000K		MFLE5101921NAN		

note driver, track and accessory not included (more specifications on next page), orientable spot ±38°, orientable spot on ball joint 360°

customizations 1-10V, DALI, Casambi, CCT 2700K

IP20



zoom optic: magnetic-mechanic fixing system on track



fixed optic: magnetic-mechanic fixing system on track



orientable spot ±38°

TRACK

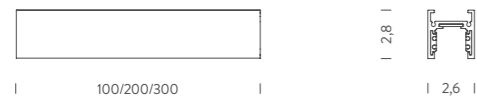

FLEX TRACK / TRACK AND ACCESSORIES

version	voltage/current	mounting	finish	code
Track 1m	24VDC	ceiling/wall	black	MFLEBKBINARIO1E
Track 2m				MFLEBKBINARIO2E
Track 3m				MFLEBKBINARIO3E
Feeding	/			MFLEBKALIM
Joint	/			MFLEBKGIUNTOAL
End-cap flex	/			MFLEBKTESTATA
End-cap flex with hole	/			MFLEBKTESTATAF
<i>note</i>	recessed mounting track available on request			

FLEX TRACK DRIVER

version	voltage/current	max power	switching	dimensions cm	code
up to 3 spots	24VDC	20W	ON-OFF	15x4x3	WALIMLED020/24
up to 8 spots		60W		18x5,2x3	WALIM60W24VIN
up to 18 spots		120W		30x4x3	WALIM120W24VIN
up to 36 spots		240W		24,4x7,1x3,8	WALIMLED240/24

ASSEMBLY AND ORIENTATION

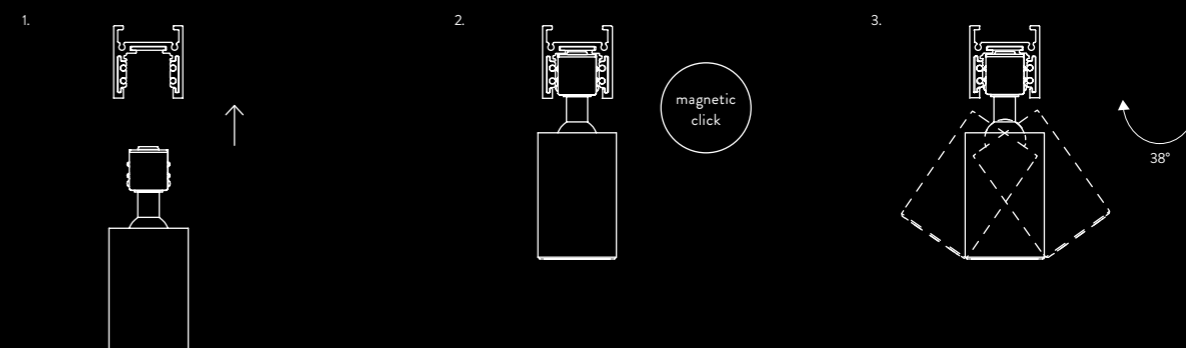

OPTICS

FIXED OPTIC

ZOOM OPTIC

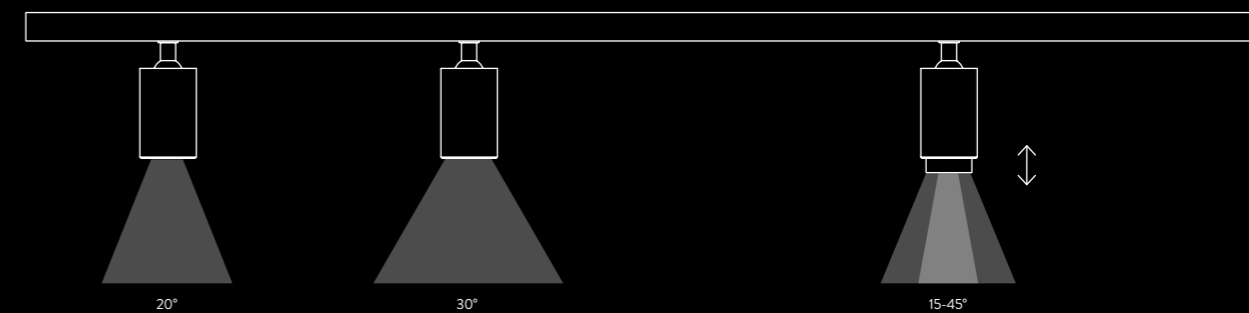

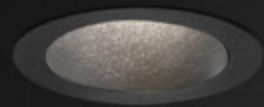

THE SPOTLIGHT
COLLECTION

1
ALICUDI

2
SALINA

3
LIPARI

Famiglia di faretti ad incasso downlight per un'illuminazione generale e d'accento in interni.

Questa collezione è caratterizzata dal design minimal, la luce soft con sistema antiabbagliamento e la facilità di installazione. Trova la sua perfetta applicazione sia in ambienti residenziali che pubblici.

Disponibile in differenti finiture, fasci ottici e temperature colore. SALINA e LIPARI inoltre, ruotano di 30° in verticale e di 355° in orizzontale, per orientare la luce a piacere e creare un'illuminazione dedicata. Gli anelli decorativi esterni, proposti in quattro finiture lucide e satinare, possono essere facilmente sostituiti grazie ad un sistema magnetico.

Family of indoor recessed downlight spotlights for indoor general and accent lighting.

This collection is characterized by minimal design, soft light without glare and a simple installation process. Perfectly suitable for residential and public applications. The versatile spotlight series are available in various finishes, beam angles and colour temperatures. SALINA and LIPARI are rotatable by 30° vertically and 355° horizontally for the free orientation of the light beam. The outer rings proposed in four matt or glossy finishes, can be easily replaced through a magnetic connection.

Familie von Downlight-Einbaustrahlern für Innenräume zur Allgemein- und Akzentbeleuchtung.

Die Kollektion an minimalistischen Einbaustrahlern verfügt über ein diffuses Licht mit Blendschutz, besonders gut geeignet für Wohnbereiche und öffentliche Gebäude. Die vielseitige Strahlerserie ist mit verschiedenen Farbausführungen, Ausstrahlungswinkeln und Farbtemperaturen erhältlich und einfach zu installieren. SALINA und LIPARI sind um 30° vertikal und 355° horizontal orientierbar, um das Licht nach Wunsch zu orientieren und eine gezielte Beleuchtung zu ermöglichen. Die äußeren Ringe sind in vier glänzenden und satinierten Ausführungen erhältlich und können dank des Magnetsystems leicht ausgetauscht werden.

Famille d'encastres downlight per un éclairage général et ponctuel indoor. Cette collection est caractérisée par le design minimal, la lumière soft avec le système anti-éblouissement et la facilité d'installation pour une application parfaite dans les espaces privés ou publics. Disponible en différentes finitions, faisceaux et températures de couleur. SALINA et LIPARI s'inclinent et pivotent de 30° vertical et 355° horizontal, permettant d'orienter de la lumière dans toute direction. Les anneaux décoratifs externes proposés dans quatre finitions polies et satin, peuvent être facilement remplacés grâce à un système magnétique.





EDGE

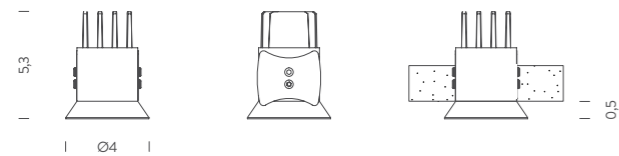

TRIM

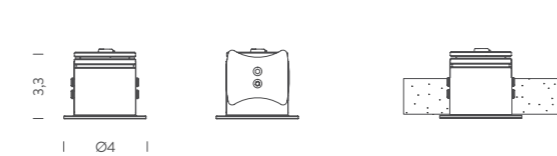

ALICUDI

voltage/current	max power	source	flux	optic	CRI	switching	mounting	CCT	finish	code	
IN 3V - 700mA	3W	LED spot	150lm	30°	>90	according to driver	recessed edge	2700K	white	ALI LW2 63	
									black	ALI LN2 63	
									3000K	white	ALI LW3 63
									black	ALI LN3 63	
				30°	recessed trim	2700K	white	ALT LW2 63			
							black	ALT LN2 63			
							3000K	white	ALT LW3 63		
							black	ALT LN3 63			

note driver not included (more specifications in the table below), edge/trim spot recessed hole Ø 35mm, depth 100mm, cable length 0,5m, series connection

IP20



recessed edge



recessed trim



ALICUDI DRIVER

version	voltage/current	max power	switching	dimensions cm	code
for 1 spot	INPUT 220-240V OUTPUT 2-4V/700mA	3W	ON-OFF	2,85x4,34x2,1	ALI ALI 61
for 1 to 4 spots	INPUT 220-240V OUTPUT 2-14V/700mA	10W	dimmmable TRIAC	11x3x2,2	ALI ALI 62
for 1 to 4 spots	INPUT 220-240V OUTPUT 2-14V/700mA	10W	dimmmable 1-10V	11x3x2,2	ALI ALI 63
for 1 to 8 spots	INPUT 110-240V OUTPUT 3-28V/700mA	20W	dimmmable DALI	12x5,2x2,2	ALI ALI 64

note series connection



TRIMLESS

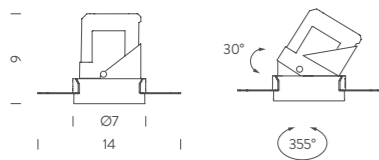

TRIM

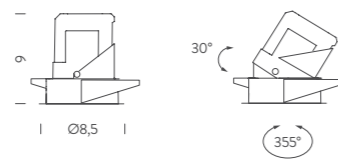

SALINA

voltage/current	max power	source	flux	optic	CRI	switching	mounting	CCT	finish	code		
IN 36V - 300mA	10W	LED spot	700lm	15°	>90	according to driver	recessed trimless	2700K	white	SAL LW2 61		
								3000K	white	SAL LW3 61		
								2700K	white	SAL LW2 63		
								3000K	white	SAL LW3 63		
								15°	recessed trim	2700K	white	SAT LW2 61
											black	SAT LN2 61
				3000K			white			SAT LW3 61		
							black			SAT LN3 61		
				35°						2700K	white	SAT LW2 63
											black	SAT LN2 63
								3000K	white	SAT LW3 63		
									black	SAT LN3 63		

note driver and ring not included (more specifications on next page), orientable spot, anti light loss system, trimless recessed hole Ø 77mm, depth 150mm, trim recessed hole Ø 75mm, depth 150mm, cable length 0,4m

IP20

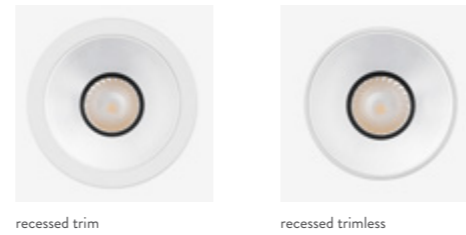

SALINA RING

finish	dimension cm	code
white matt	Ø 6,8	SAR LW1 61
black matt	Ø 6,8	SAR LB1 61
black glossy	Ø 6,8	SAR LB2 61
silver glossy	Ø 6,8	SAR LD1 61

note magnetic fixing

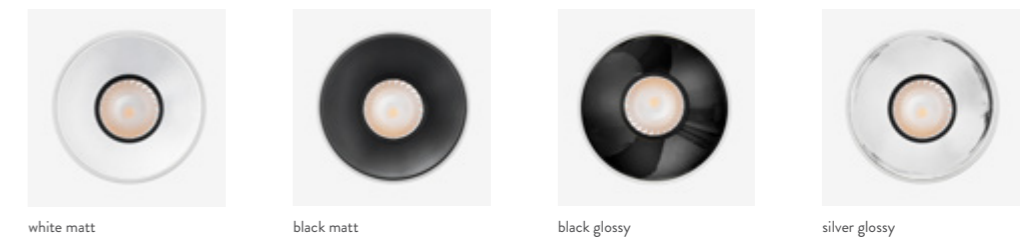

SALINA DRIVER

version	voltage/current	max power	switching	dimensions cm	code
for 1 spot	INPUT 220-20V OUTPUT 40V/250mA	10W	ON-OFF	8,8x3,9x2,2	SAL ALI 61
for 1 spot	INPUT 220-240V OUTPUT 9-42V/300mA	10W	dimnable TRIAC	11x3x2,2	SAL ALI 62
for 1 spot	INPUT 220-240V OUTPUT 9-42V/300mA	10W	dimnable 1-10V	11x3x2,2	SAL ALI 63
for 1 spot	INPUT 220-240V OUTPUT 9-40V/300mA	10W	dimnable DALI	15x4,3x2,9	SAL ALI 64



Lipari Trim, black finish



Lipari Trim, black finish

TRIMLESS

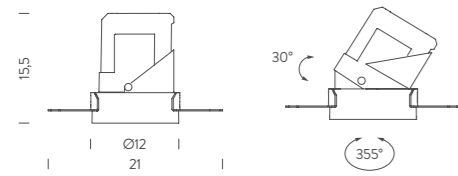

TRIM

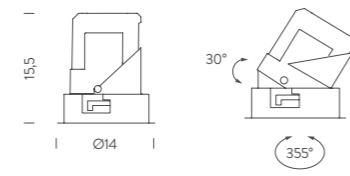

LIPARI

voltage/current	max power	source	flux	optic	CRI	switching	mounting	CCT	finish	code		
IN 36V - 600mA	28W	LED spot	1400lm	15°	>90	according to driver	recessed trimless	2700K	white	LIP LW2 61		
								3000K	white	LIP LW3 61		
								35°	2700K	white	LIP LW2 63	
									3000K	white	LIP LW3 63	
								15°	recessed trim	2700K	white	LIT LW2 61
											black	LIT LN2 61
				3000K	white	LIT LW3 61						
					black	LIT LN3 61						
				35°	2700K	white	LIT LW2 63					
					3000K	white	LIT LW3 63					
						black	LIT LN3 63					

note driver and ring not included (more specifications on next page), orientable spot, anti light loss system, trimless recessed hole Ø 130mm, depth 200mm, trim recessed hole Ø 125mm, depth 200mm, cable length 0,4m

IP20



recessed trim

recessed trimless



LIPARI RING

finish	dimension cm	code
white matt	Ø11,8	LIR LW1 61
black matt	Ø11,8	LIR LB1 61
black glossy	Ø11,8	LIR LB2 61
silver glossy	Ø11,8	LIR LD1 61
<i>note</i>	magnetic fixing	

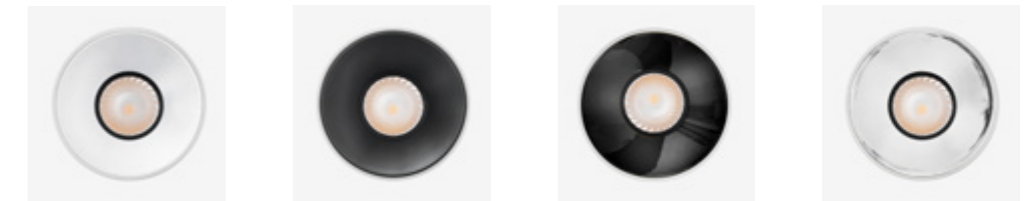

white matt

black matt

black glossy

silver glossy

LIPARI DRIVER

version	voltage/current	max power	switching	dimensions cm	code
for 1 spot	INPUT 220-240V OUTPUT 31-46V/ 600mA	28W	ON-OFF	9,72x4,3x3	LIP ALI 61
for 1 spot	INPUT 220-240V OUTPUT 9-42V/ 600mA	30W	dimmmable TRIAC	15x4,3x2,9	LIP ALI 62
for 1 spot	INPUT 220-240V OUTPUT 9-42V/ 600mA	30W	dimmmable 1-10V	15x4,3x2,9	LIP ALI 63
for 1 spot	INPUT 220-240V OUTPUT 9-42V/ 600mA	30W	dimmmable DALI	15x4,3x3	LIP ALI 64

ALICUDI

EDGE

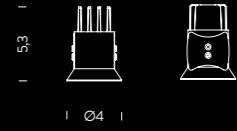

TRIM

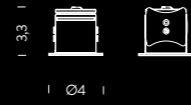

LIPARI

TRIMLESS

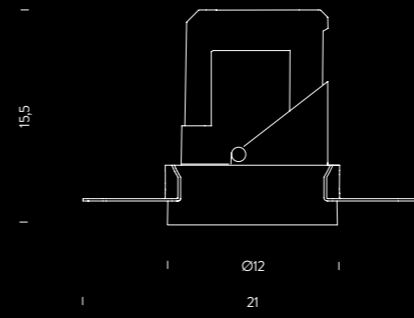

TRIM

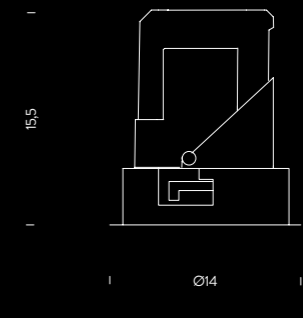

SALINA

TRIMLESS

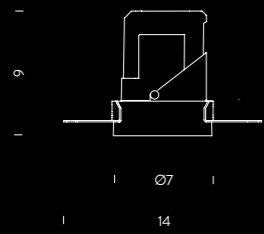

TRIM

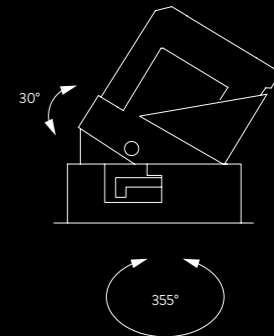
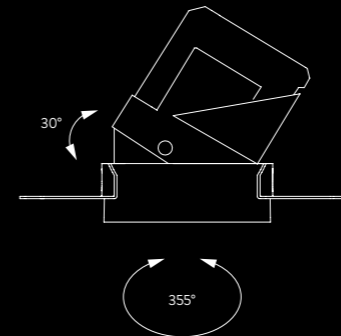
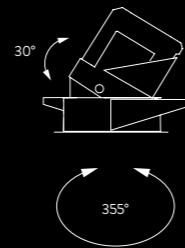
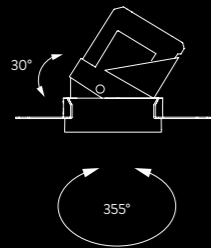
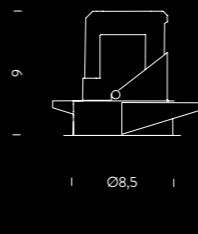



LUX INDOOR è un mini spot ad incasso dalle ridotte dimensioni dedicato ad un'illuminazione decorativa e di segnalazione in interni.

Corpo in alluminio anodizzato di ridotte dimensioni e con ottica da 100° o opal, per un'illuminazione omogenea. Può essere fissato tramite dado, con due O-ring in gomma o con molla di fissaggio.

LUX INDOOR is a small recessed spot for decorative and signalization indoor lighting.

Made of an aluminium body with a 100° optic or opal beam for a homogeneous lighting effect.

Installation through nut, two O-rings or fixing springs.

Die Kollektion LUX INDOOR ist der dekorativen Akzentbeleuchtung für Innenräume gewidmet.

Eloxiertes Aluminiumgehäuse und 100°- oder Opal-Optik für einen homogenen Lichteffect.

Befestigung mit einer Mutter, mit zwei Gummi-O-Ringen oder mit einer Befestigungsfeder.

LUX INDOOR est plutôt dédié à l'éclairage décoratif et de balisage indoor.

Corps en aluminium anodisé de petite taille avec optique 100° ou opale, pour un éclairage homogène. Il peut être fixé avec un écrou, avec deux joints toriques en caoutchouc ou avec un ressort de fixation.



Lux Indoor, aluminium finish

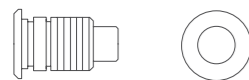

2,8

Ø1,9

LUX INDOOR

voltage/current	max power	source	flux	optic	CRI	switching	mounting	CCT	finish	code
IN 3V - 350mA	1,2W	LED spot	53lm	100°	90	according to driver	recessed	3000K	Grey	BLUX0101717WAA
				opal						BLUX0101G17WAA
			84lm	100°	80			4000K		BLUX0101717NAA
				opal						BLUX0101G17NAA
<i>note</i>	driver not included (more specifications in the table below), recessed hole Ø 16mm, depth 50mm, cable length 0,25m, spring/nut/O-ring mounting accessory (included), series connection									
<i>customizations</i>	DALI, DMX, Casambi									

 IP40

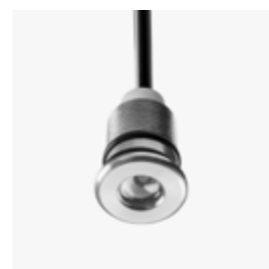

anodized aluminium body

LUX INDOOR DRIVER

version	voltage/current	max power	IP	switching	dimensions cm	code
for 1 spot	350mA	1,4W	66	ON-OFF	3,8x3x2,3	WALIMLED01350
for 3 spots		4W	20		4x4x2,1	WALIMLED03350
for 3-8 spots		12W	20		9,8x3,3x2,2	WALIMLED08350
for 3-12 spots		17W	20		12,2x3,8x2,4	WALIMLED12350
for 12 spots		15W	20	dimmmable 1-10V	10,3x6,7x2,1	WALI/DIMM/JOLLY
<i>note</i>	series connection					

La collezione LUX racchiude una selezione di spots dalle ridotte dimensioni ed alte performance, dedicati all'illuminazione in esterni. A seconda del tipo di fissaggio e della tipologia di illuminazione necessaria, la collezione LUX propone spots realizzati in alluminio anodizzato, ottone cromato satinato e tecno-polimero ad incasso (R e OUTDOOR) e con fissaggio esterno (S, W e GARDEN). Gli spots sono disponibili con differenti finiture, temperature colore, fasci ottici e dimmerabili 1-10V e DALI. La versione LUX GARDEN è orientabile e regolabile nell'installazione outdoor nel terreno grazie ad un'apposita asticella, il faretto scorre sull'asta permettendone il posizionamento a piacere. LUX OUTDOOR è caratterizzato da un corpo in ottone cromato satinato, calpestabile e con grado di protezione IP68 che consente un'applicazione in immersione fino ad un massimo di 1m. LUX W è una famiglia di spots con fissaggio a parete dedicata all'illuminazione d'accento e decorativa di facciate. La collezione è realizzata in alluminio anodizzato con finitura naturale o nero. LUX W è proposto con emissione luminosa singola e doppia ed è disponibile con due diverse temperature colore e fasci ottici. Il corpo degli spots è orientabile in fase di installazione e permette quindi di direzionare l'emissione di luce a piacere. Indice di resa cromatica è maggiore di 90 e il fissaggio a parete avviene tramite una base che contiene l'alimentatore.

LUX collection includes a high-performance small spots selection, suitable for outdoor applications. The collection consists of the recessed aluminium, sanded chromed brass and techno-polymer spots, (R and OUTDOOR) and the surface solutions (S, W and GARDEN). Spots are available in different finishes, colour temperatures and beam angles. Dimmable via 1-10V and DALI. LUX GARDEN is proposed on a special rod for outdoor installations in the ground and is orientable and adjustable and the spot slides on the rod allowing positioning as desired. LUX OUTDOOR is realized in a resistant sanded chromed brass body with an IP68 rating, making it ideal for spaces with foot traffic and underwater installations up to 1m deep. LUX W is a spots collection suitable to accent and decorative lighting of façades. Spots are made from anodized aluminium in either natural grey or black finish. Available with single and double light emission and in varying colour temperatures and optic beams. The body is rotatable during installation and allows the adjustment of the light to adhere to specific project. The product features a color rendering index higher than 90 and an on-board driver.

Die LUX-Kollektion umfasst eine Auswahl an kleinen, leistungsstarken Strahlern für die Außenbeleuchtung. Je nach Befestigungs- und gewünschter Beleuchtungsart bietet die LUX-Kollektion Strahler aus eloxiertem Aluminium, satiniertem Chrommessing und Techno-Polymer für den Einbau (R und OUTDOOR) und für die Außenbefestigung (S, W und GARDEN). Die Strahler sind mit verschiedenen Oberflächen, Farbtemperaturen und Optiken erhältlich und sind 1-10V und DALI dimmbar. LUX GARDEN hat einen speziellen Fuß für die Außenmontage im Boden. Der Strahler wird auf ihrer Schiene nach Wunsch positioniert werden. Das Gehäuse des LUX OUTDOOR besteht aus verchromt satiniertem Messing. IP68. Begebar und für Installationen Unterwasser bis zu 1m Tiefe. LUX W ist eine Wandstrahler-Kollektion für die Akzent- und Dekorationsbeleuchtung von Fassaden. Die Spots sind aus eloxiertem Aluminium in naturgrauer oder schwarzer Ausführung gefertigt. Erhältlich mit einfachem und doppeltem Lichtaustritt und in verschiedenen Farbtemperaturen und optischen Ausstrahlungen. Der Körper ist während der Installation drehbar und ermöglicht die Anpassung des Lichts an die spezifischen Projektanforderungen. Farbwiedergabeindex > 90 und Wandbefestigung über einen Sockel mit integriertem Treiber.

La collection LUX contient une sélection de petits spots hautement performants, pour éclairage extérieur. En fonction du type de fixation et du type d'éclairage souhaité, la collection LUX propose des spots encastrés en aluminium anodisé, laiton chromé satiné et techno-polymère (R et OUTDOOR), avec fixation externe (S, W et GARDEN). Les spots sont disponibles en différentes finitions, températures de couleur, faisceaux et dimmables 1-10V et DALI. La version LUX GARDEN est orientable et réglable pour une installation extérieure dans le sol grâce à une tige spéciale. Le spot se glisse sur toute la tige permettant de le positionner librement. LUX OUTDOOR se caractérise par un corps en laiton chromé satiné, piétonnie. Degré de protection IP68 qui permet une immersion jusqu'à un maximum de 1 m. LUX W est une famille de spots avec fixation murale dédiée à l'éclairage ponctuel et décoratif de façade. La collection est en aluminium anodisé avec une finition naturelle ou noire. LUX W est proposé en émission lumineuse simple ou double, avec deux températures de couleur et faisceaux optiques différents. Le corps des spots est orientable lors de la phase d'installation et permet ainsi de fixer le flux lumineux au choix. L'indice de rendu des couleurs est supérieur à 90 et la fixation au mur se fait grâce à une patère incluant l'alimentation.





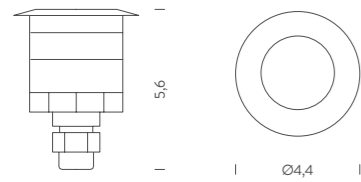

LUX OUTDOOR

voltage/current	max power	source	flux	optic	CRI	switching	mounting	CCT	finish	code
IN 3V - 350mA	1,2W	LED spot	73lm	11°	90	according to driver	recessed	3000K	grey	BLUX0201F17WCS
			68lm	25°						BLUX0201417WCS
			50lm	80°						BLUX0201617WCS
			100lm	11°	70	5000K	grey	BLUX0201F170CS		
			75lm	25°				BLUX02014170CS		
			55lm	80°	90	3000K	white	BLUX02016170CS		
			73lm	11°				BLUX0201F17WTF		
			68lm	25°				BLUX0201417WTF		
			50lm	80°				BLUX0201617WTF		
			100lm	11°				70	5000K	BLUX0201F170TF
			75lm	25°						BLUX02014170TF
			55lm	80°	BLUX02016170TF					

note driver not included, recessed box BLUXCASSA1 not included (more specifications on next page), cable length 1m, series connection

customizations 1-10V, DALI, DMX, Casambi, CCT 2700K

IP68



sanded chromed brass



techno-polymer

LUX OUTDOOR DRIVER

version	voltage/current	max power	IP	switching	dimensions cm	code
for 1 spot	350mA	1,4W	66	ON-OFF	3,8x3x2,3	WALIMLED01350
for 3 spots		4W	20		4x4x2,1	WALIMLED03350
for 3-8 spots		12W	20		9,8x3,3x2,2	WALIMLED08350
for 3-12 spots		17W	20		12,2x3,8x2,4	WALIMLED12350
for 12 spots		15W	20	dimnable 1-10V	10,3x6,7x2,1	WALI/DIMM/JOLLY
<i>note</i>	for outdoor installation IP connection system not included					

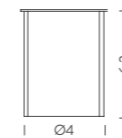

ACCESSORIES

version	finish	dimensions cm	code
RECESSED BOX for 1 spot	ABS	Ø4x6,2	BLUXCASSA1
<i>note</i>	installation BOX, not IP rated		



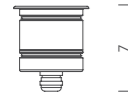

Ø5,25

LUX R

voltage/current	max power	source	flux	optic	CRI	switching	mounting	CCT	finish	code	
IN 12V-350mA	4,2W	LED spot	366lm	17°	90	according to driver	recessed	3000K	grey	BLUR1901N21WAA	
			372lm	46°						BLUR1901F21WAA	
			366lm	17°						4000K	BLUR1901N21NAA
			372lm	46°						BLUR1901F21NAA	
			366lm	17°				3000K	black	BLUR1901N21WAN	
			372lm	46°						BLUR1901F21WAN	
			366lm	17°						4000K	BLUR1901N21NAN
			372lm	46°						BLUR1901F21NAN	

note cable 1m, recessed box LUXCASSA4 not included, driver not included, compatible control: 1-10V, DALI, DMX, Casambi, series connection

IP67

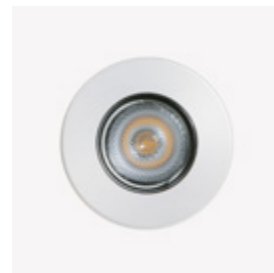

transparent diffuser



grey finish

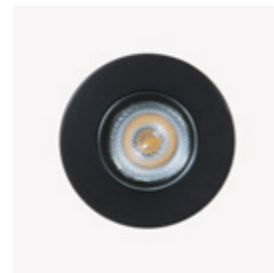

transparent diffuser



black finish

LUX R DRIVER

version	voltage/current	max power	IP	switching	dimensions cm	code
for 2 spots	350mA	12W	20	ON-OFF	9,8x3,3x2,2	WALIMLED08350
for 3 spots		17W			12,2x3,8x2,4	WALIMLED12350
for 5 spots		15W		dimnable 1-10V	10,3x6,7x2,1	WALI/DIMM/JOLLY
		25W			12,4x7,9x2,2	WALI/MAXI/JOLLY

note for outdoor installation IP connection system not included

ACCESSORIES

version	finish	dimensions cm	code
RECESSED BOX for 1 spot	ABS	Ø6,2x10	BLUXCASSA4
<i>note</i>	installation BOX, not IP rated		



Ø6,2





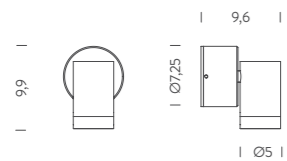

LUX W-S (SINGLE)

voltage/current	max power	source	flux	optic	CRI	switching	mounting	CCT	finish	code
220/240V	4,2W	LED spot	366lm	17°	90	on/off	wall	3000K	grey	BLUW4101N21WAA
			372lm	46°						BLUW4101F21WAA
			366lm	17°				4000K		BLUW4101N21NAA
			372lm	46°						BLUW4101F21NAA
			366lm	17°				3000K	black	BLUW4101N21WAN
			372lm	46°						BLUW4101F21WAN
			366lm	17°				4000K		BLUW4101N21NAN
			372lm	46°						BLUW4101F21NAN

note driver included

IP65



grey finish



black finish



Lux W-S, grey finish



Lux W-S, black finish



Lux W-D, black finish

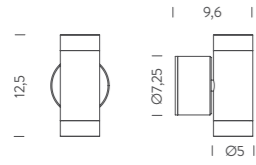

LUX W-D (DOUBLE)

voltage/current	max power	source	flux	optic	CRI	switching	mounting	CCT	finish	code
220/240V	8,4W	LED spot	732lm	17°	90	on/off	wall	3000K	grey	BLUW4102N2IWAA
			744lm	46°						BLUW4102F2IWAA
			732lm	17°					4000K	BLUW4102N2INAA
			744lm	46°					BLUW4102F2INAA	
			732lm	17°				3000K	black	BLUW4102N2IWAN
			744lm	46°						BLUW4102F2IWAN
			732lm	17°					4000K	BLUW4102N2INAN
			744lm	46°					BLUW4102F2INAN	

note driver included

IP65



grey finish



black finish



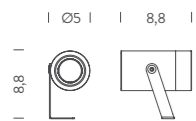

Lux W-D, grey finish

**LUX S**

voltage/current	max power	source	flux	optic	CRI	switching	mounting	CCT	finish	code		
IN 12V-350mA	4,2W	LED spot	366lm	17°	90	according to driver	surface	3000K	grey	BLUS1801N21WAA		
			372lm	46°						BLUS1801F21WAA		
			366lm	17°						4000K	BLUS1801N21NAA	
			372lm	46°						BLUS1801F21NAA		
			366lm	17°						3000K	black	BLUS1801N21WAN
			372lm	46°						BLUS1801F21WAN		
			366lm	17°						4000K	BLUS1801N21NAN	
			372lm	46°						BLUS1801F21NAN		

note cable 2m, peg BLUXSPEG not included, driver not included. Compatible control: 1-10V, DALI, DMX, Casambi, series connection

customizations CCT 2700K

IP67

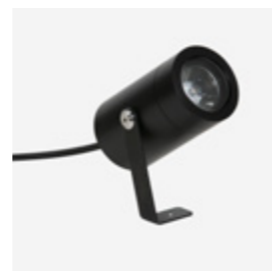

orientable spot

LUX S DRIVER

version	voltage/current	max power	IP	switching	dimensions cm	code
for 2 spots	350mA	12W	20	ON-OFF	9,8x3,3x2,2	WALIMLED08350
for 3 spots		17W			12,2x3,8x2,4	WALIMLED12350
for 5 spots		15W		dimnable 1-10V	10,3x6,7x2,1	WALI/DIMM/JOLLY
		25W			12,4x7,9x2,2	WALI/MAXI/JOLLY

note for outdoor installation IP connection system not included

**ACCESSORIES**

version	finish	dimensions cm	code
PEG for 1 spot	black	19x3x2	BLUXSPEG

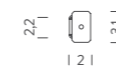

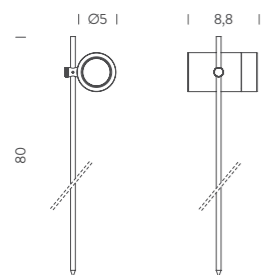

**LUX GARDEN**

voltage/current	max power	source	flux	optic	CRI	switching	mounting	CCT	finish	code	
IN 12V-350mA	4,2W	LED spot	366lm	17°	90	according to driver	ground	3000K	grey	BLUG3001N21WAA	
			372lm	46°					BLUG3001F21WAA		
			366lm	17°					4000K	BLUG3001N21NAA	
			372lm	46°					BLUG3001F21NAA		
			366lm	17°					3000K	black	BLUG3001N21WAN
			372lm	46°					BLUG3001F21WAN		
			366lm	17°					4000K	BLUG3001N21NAN	
			372lm	46°					BLUG3001F21NAN		
			366lm	17°					3000K	green	BLUG3001N21WVE
			372lm	46°					BLUG3001F21WVE		
			366lm	17°					4000K	BLUG3001N21NVE	
			372lm	46°					BLUG3001F21NVE		

note driver not included, cable length 2m, compatible control: 1-10V, DALI, DMX, Casambi, series connection

customizations CCT 2700K

IP67



grey finish



green finish



orientable spot

LUX GARDEN DRIVER

version	voltage/current	max power	IP	switching	dimensions cm	code
for 2 spots	350mA	12W	20	ON-OFF	9,8x3,3x2,2	WALIMLED08350
for 3 spots		17W			12,2x3,8x2,4	WALIMLED12350
		15W		dimmmable 1-10V	10,3x6,7x2,1	WALI/DIMM/JOLLY
for 5 spots		25W			12,4x7,9x2,2	WALI/MAXII/JOLLY

note for outdoor installation IP connection system not included

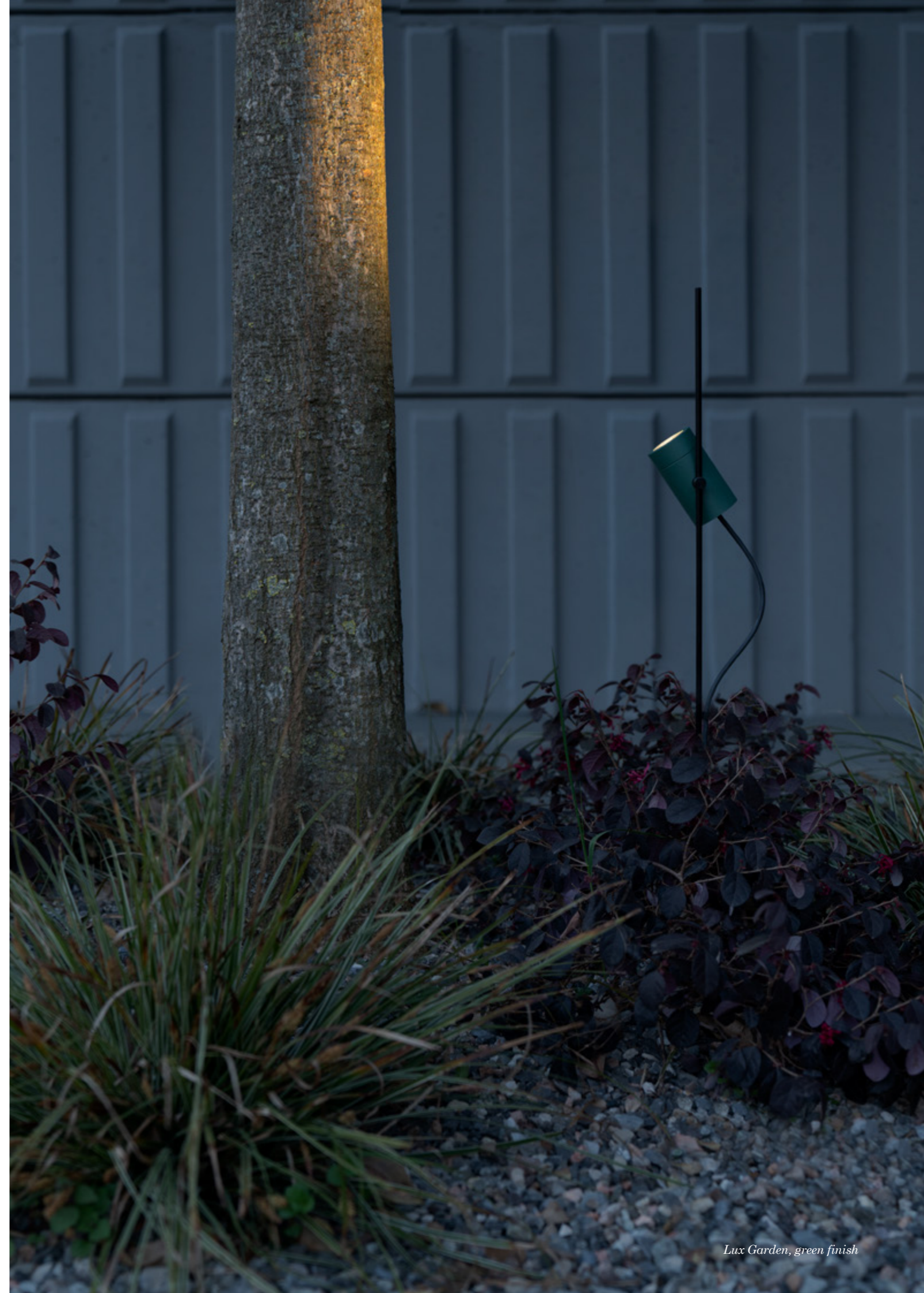

Lux Garden, green finish



Lux Garden, green finish



Lux Garden, green finish



La collezione SLACKLINE è composta da un'ampia selezione di profili in alluminio anodizzato naturale, proposti con quattro tipologie di fissaggio: recessed, ceiling, pendant e recessed trimless. Il sistema lineare si presenta così nelle versioni SLACKLINE REGULAR, SLACKLINE TRIM e SLACKLINE MICRO. Ogni profilo SLACKLINE è caratterizzato da un design minimal, da un'elevata qualità della luce garantita da un indice di resa cromatica superiore a 94 e da uno schermo opale che permette un'emissione luminosa omogenea.

A seconda del tipo di fissaggio, è proposto in differenti lunghezze standard. SLACKLINE rappresenta il prodotto ideale per realizzare soluzioni in linea continua, a fronte di specifiche necessità di progetto. La peculiarità del sistema SLACKLINE lo rendono particolarmente adatto ad applicazioni eterogenee che vanno da contesti retail, residenziali, sino al museale.

The versatile SLACKLINE is a profile luminaire available in a wide selection of versions: recessed, semi-recessed and surface-mounted for wall or ceiling mounting. The three versions SLACKLINE REGULAR, SLACKLINE TRIM and SLACKLINE MICRO are characterised by minimal design, ease of installation and excellent light quality (CRI > 94). Includes an opal diffuser for a homogenous light effect.

SLACKLINE is ideal for custom linear lighting solutions. Available in various standard lengths or in bespoke sizes on request, making it an extremely flexible system suitable for ambience lighting in any environment, including retail, residential and museum.

Die SLACKLINE-Kollektion besteht aus einer großen Auswahl an eloxiertem Aluminium-Profilen, die in vier verschiedenen Befestigungsarten angeboten werden: als Einbau- (recessed), als randlose Einbau- (recessed trimless), als Decken- (ceiling) und als Pendelversion (pendant). Alle SLACKLINE-Modelle haben ein minimales Design, eine einfache Montage und eine hervorragende Lichtqualität (CRI > 94). Der Opale Diffusor sorgt für eine homogene und blendfreie Lichtausstrahlung.

SLACKLINE ist ideal für lineare Lichtinstallationen.

Dank der Eigenschaften des Systems, ist SLACKLINE für heterogene Anwendungen geeignet, die von Einzelhandel über Wohnbereiche bis hin zu Museen reichen.

La collection SLACKLINE est composée d'une vaste sélection de profilés en aluminium anodisé naturel, proposés avec quatre typologies: encastré, plafonnier, suspension et encastré trimless. Le système linéaire se présente ainsi pour les versions SLACKLINE REGULAR, SLACKLINE TRIM et SLACKLINE MICRO. Chaque profilé SLACKLINE est caractérisé d'un design minimal, d'une haute qualité de lumière garantie par un indice de rendu chromatique supérieur à 94 et d'un diffuseur opale pour une émission lumineuse homogène. Selon le type de montage il est proposé différentes longueurs standards. SLACKLINE représente le produit idéal pour réaliser des solutions en ligne continue selon les besoins spécifiques du projet. Les caractéristiques du système SLACKLINE le rendent particulièrement adapté pour des applications multiples telles commerce, résidentiel et musée en indoor.



PENDANT

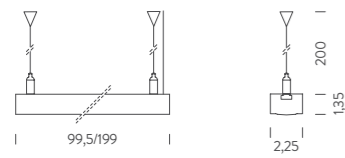

WALL

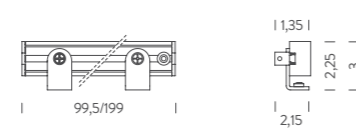

CEILING

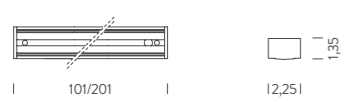

RECESSED

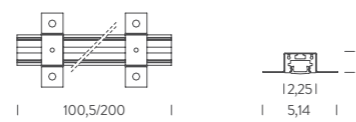

SLACKLINE

REGULAR PENDANT

version	voltage/current	max power	source	flux	optic	CRI	switching	mounting	CCT	finish	code
1m	24VDC	15W	linear LED	860lm	diffused	97	acc. to driver	pendant	3000K	grey	BSLA0310G26WAA
				890lm		94			4000K	BSLA0310G26NAA	
2m		30W		1720lm		97			3000K		BSLA0320G26WAA
				1780lm		94			4000K	BSLA0320G26NAA	

REGULAR WALL

1m	24VDC	15W	linear LED	860lm		97		wall	3000K		BSLA4010G26WAA
				890lm		94			4000K	BSLA4010G26NAA	
2m		30W		1720lm		97			3000K		BSLA4020G26WAA
				1780lm		94			4000K	BSLA4020G26NAA	

REGULAR CEILING

1m	24VDC	15W	linear LED	860lm		97		ceiling	3000K		BSLA0410G26WAA
				890lm		94			4000K	BSLA0410G26NAA	
2m		30W		1720lm		97			3000K		BSLA0420G26WAA
				1780lm		94			4000K	BSLA0420G26NAA	

REGULAR RECESSED

1m	24VDC	15W	linear LED	860lm		97		recessed	3000K		BSLA2110G26WAA
				890lm		94			4000K	BSLA2110G26NAA	
2m		30W		1720lm		97			3000K		BSLA2120G26WAA
				1780lm		94			4000K	BSLA2120G26NAA	

note driver not included (more specifications on p.161), cable length 0,5m (ceiling, wall, recessed), 2m (pendant),

customizations 1-10V, DALI, DMX, Casambi, CCT 2700K, body length

IP40



pendant



wall



ceiling



recessed

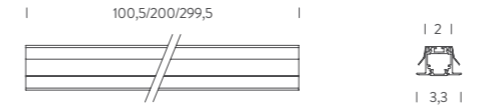

SLACKLINE

TRIM RECESSED

version	voltage/current	max power	source	flux	optic	CRI	switching	mounting	CCT	finish	code
1m	24VDC	15W	linear LED	560lm	diffused	97	acc. to driver	recessed	3000K	grey	BSLA0110G26WAA
				660lm		94			4000K	BSLA0110G26NAA	
2m		30W		1120lm		97			3000K		BSLA0120G26WAA
				1320lm		94			4000K	BSLA0120G26NAA	
3m		45W		1980lm		97			3000K		BSLA0130G26WAA
				1680lm		94			4000K	BSLA0130G26NAA	

note driver not included (more specifications on p.161), cable length 0,5m

customizations 1-10V, DALI, DMX, Casambi, CCT 2700K, body length

IP40

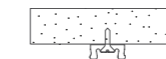

trim recessed

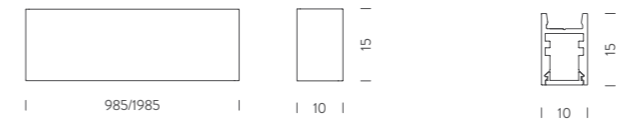

MICRO

version	voltage/current	max power	source	flux	optic	CRI	switching	mounting	CCT	finish	code
1m	24VDC	15W	linear LED	457lm	diffused	90	acc. to driver	surface	3000K	grey	BSLM0410G65WAA
				540lm					4000K	BSLM0410G65NAA	
2m		30W		914lm					3000K		BSLM0420G65WAA
				1080lm					4000K	BSLM0420G65NAA	

note driver not included (more specifications on p. 161), cable length 0,5m

customizations 1-10V, DALI, DMX, Casambi, CCT 2700K, body length

IP40



micro wall



SLACKLINE DRIVER

<i>version</i>	<i>voltage/current</i>	<i>max power</i>	<i>IP</i>	<i>switching</i>	<i>dimensions cm</i>	<i>code</i>
24VDC	IN 100/240VAC - OUT 24VDC	20W	20	ON-OFF	15x4x3	WALIMLED020/24
		25W	67		14,8x4x3,2	WALIMLED25/24IP
		60W	20		18x5,2x3	WALIM60W24VIN
		60W	67		17,2x5,3x3,7	WALIM60W24V
		80W	20		24,1x4,3x3	WALIM80W24V
		100W	67		14x6,3x3,2	WALIMLED100/24
		120W	20		30x4x3	WALIM120W24VIN
		150W	20		18x6,5x3,1	WALIM150W24VIN
		150W	67		25x6,8x4,5	WALIMLED150/24
		240W	67		24,4x7,1x3,8	WALIMLED240/24
		250W	20		19,5x6,7x3,2	WALIMLED250W24VIN

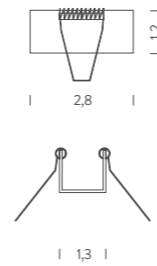

RECESSED FIX KIT

<i>version</i>	<i>dimensions cm</i>	<i>code</i>
for slackline trim recessed	2,8x1,2x1,3	BSLACKITSTAF01



La famiglia SHARP presenta una serie di proiettori museali, con fissaggio a binario, sviluppati per valorizzare e preservare al meglio le opere d'arte grazie alla grande flessibilità di utilizzo e all'elevata qualità della luce.

La collezione SHARP è composta da due versioni: SHARP FRAME, proiettore con ottica framing che permette di sagomare il fascio di luce secondo la necessità di progetto attraverso l'uso di lamelle laterali e SHARP ZOOM, dotato di ottica variabile con zoom on-board che consente di variare in modo semplice il fascio di luce passando da un minimo di 7° ad un massimo di 55°. La famiglia SHARP è disponibile con finiture e temperature colore differenti, fornita di dimmer on-board e alimentatore integrato.

The SHARP track-mounted spotlight was developed especially with museums in mind. With a CRI > 94, the spot family illuminates artworks with a high-quality light with near perfect colour reproduction. Focus and beam angle are adjustable. Projectors have an on-board dimmer and an integrated driver. Available in two product variants: SHARP ZOOM and SHARP FRAME. SHARP ZOOM has an integrated variable optic to adjust the light focus from 7° to 55°. SHARP FRAME features built-in framing optics to create sharp-edged light cut-outs and creates an even more exciting light effect. Available in white (with grey accents) or black anodized aluminium. Supplied with integrated dimmer and power supply unit and available in three colour temperatures.

SHARP ist eine Familie von Stromschienenstrahler, die speziell für Museen entwickelt wurde, um Kunstwerke dank ihrer großen Anwendungsflexibilität und der hohen Lichtqualität aufzuwerten und zu erhalten. Die SHARP-Kollektion besteht aus zwei Versionen: SHARP FRAME und SHARP ZOOM.

SHARP FRAME ist ein Projektor mit einer Rahmenoptik, die es ermöglicht, den Lichtstrahl durch den Einsatz von Seitenlamellen entsprechend den Anforderungen des Projekts zu formen. SHARP ZOOM hat eine integrierte variable Optik mit integriertem Zoom zur Einstellung des Lichtfokus von 7° bis 55°. Die SHARP-Familie ist mit verschiedenen Oberflächen und Farbtemperaturen erhältlich, ausgestattet mit On-Board-Dimmer und integriertem Treiber.

La famille SHARP présente une série de projecteurs muséographiques, sur rail, développés pour la mise en valeur et la préservation des œuvres d'art grâce à la grande flexibilité d'utilisation et la qualité élevée de la lumière LED. La collection SHARP est composée de deux versions: SHARP FRAME, projecteur avec cadre à volets orientables permettant le découpage du faisceau lumineux et SHARP ZOOM avec optique zoom variable de 7 à 55°. La famille SHARP est disponible en différentes finitions et températures de couleur. Driver intégré et dimmer on-board.



Sharp Zoom black finish

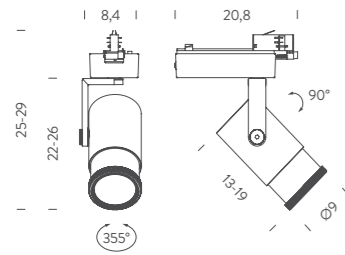

SHARP

ZOOM

voltage/current	max power	source	flux	optic	CRI	switching	mounting	CCT	finish	code
220/240V	25W	LED spot	1546lm (55°)	7°-55°	> 94	dimmable 1-10V	track	2700K	white	MPFB8001929DBG
									black	MPFB8001929DAN
			1560lm (55°)	3000K					white	MPFB8001929WBG
				black					MPFB8001929WAN	
			1890lm (55°)	4000K					white	MPFB8001929NBG
				black					MPFB8001929NAN	
<i>note</i>	driver on board, dimming control on board, rotating body 355°, orientable spot 90°, compatible with TRACK 3~230V p.174, black anodized finish or varnished white with grey details									
			1546lm (55°)			dimmable DALI		2700K	white	MPFBDA01929DBG
									black	MPFBDA01929DAN
			1560lm (55°)					3000K	white	MPFBDA01929WBG
									black	MPFBDA01929WAN
			1890lm (55°)					4000K	white	MPFBDA01929NBG
									black	MPFBDA01929NAN
<i>note</i>	driver on board, rotating body 355°, orientable spot 90°, compatible with TRACK 3~230V (DALI) p.174, black anodized finish or varnished white with grey details									
<i>accessory</i>	oval frontal lens									
<i>customizations</i>	CRI, CCT, Casambi accessory, other track adapter									

IP20



orientable 90°

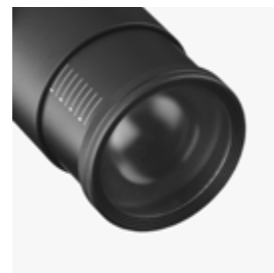

zoom optic 7-55°



dimming control on board

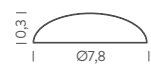

OVAL FRONTAL LENS

finish	dimensions cm	code
PMMA	Ø7,8x0,3	MPFBASYMFILTER

ZOOM OPTIC 7°-55°

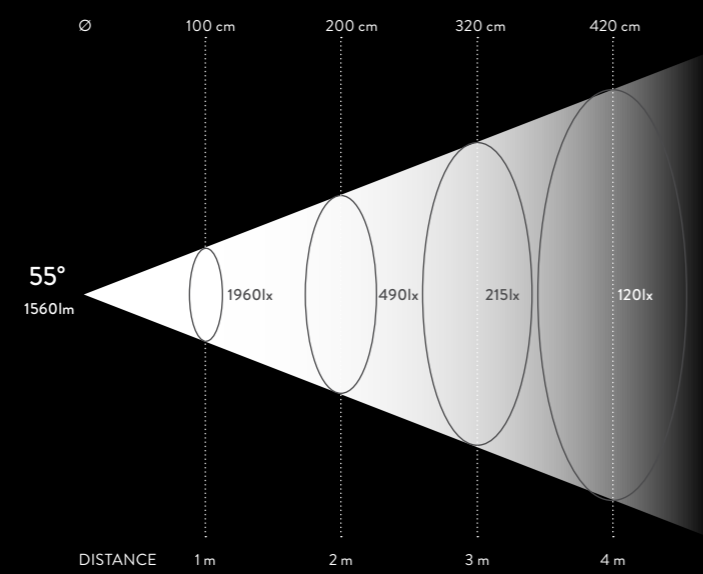
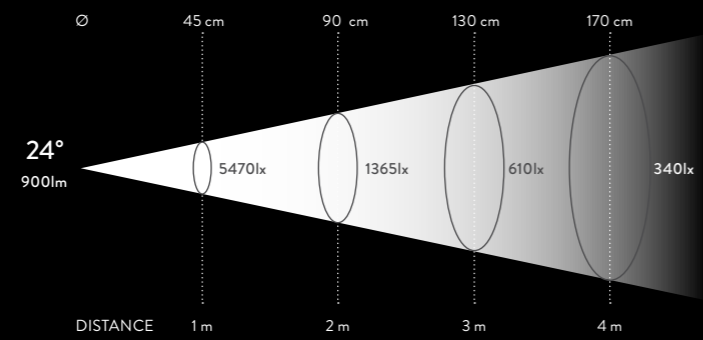
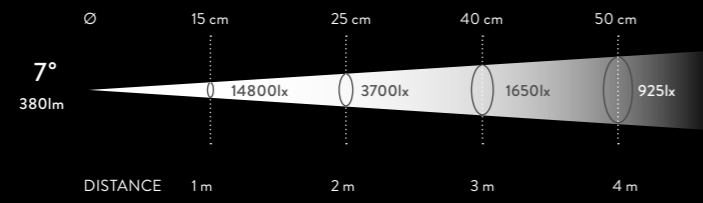

Sharp Zoom, white finish



Soft frontal lens included

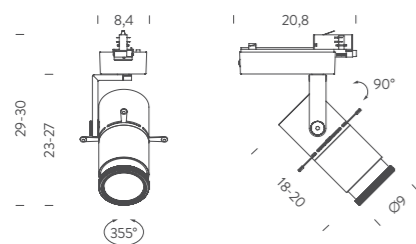

Oval frontal lens on demand

**SHARP****FRAME**

voltage/current	max power	source	flux	optic	CRI	switching	mounting	CCT	finish	code	
220/240V	23W	LED spot	870lm	focus/frame	> 94	dimmable 1-10V	track	2700K	white	MPFB8001C29DBG	
									black	MPFB8001C29DAN	
			920lm						3000K	white	MPFB8001C29WBG
			black						MPFB8001C29WAN		
			1070lm						4000K	white	MPFB8001C29NBG
			black						MPFB8001C29NAN		

note driver on board, dimming control on board, rotating body 355°, orientable spot 90°, compatible with TRACK 3-230V p.174, black anodized finish or varnished white with grey details

870lm	dimmable DALI	2700K	white	MPFBDA01C29DBG		
			black	MPFBDA01C29DAN		
			920lm	3000K	white	MPFBDA01C29WBG
			black	MPFBDA01C29WAN		
			1070lm	4000K	white	MPFBDA01C29NBG
			black	MPFBDA01C29NAN		

note driver on board, rotating body 355°, orientable spot 90°, compatible with TRACK 3-230V (DALI) p.174, black anodized finish or varnished white with grey details

customizations CRI, CCT, Casambi accessory, other track adapter

IP20



orientable spot 90°

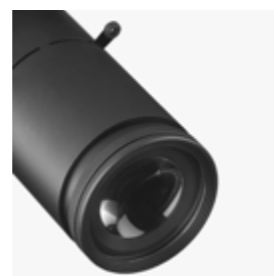

soft variable/framing optic



dimming control on board

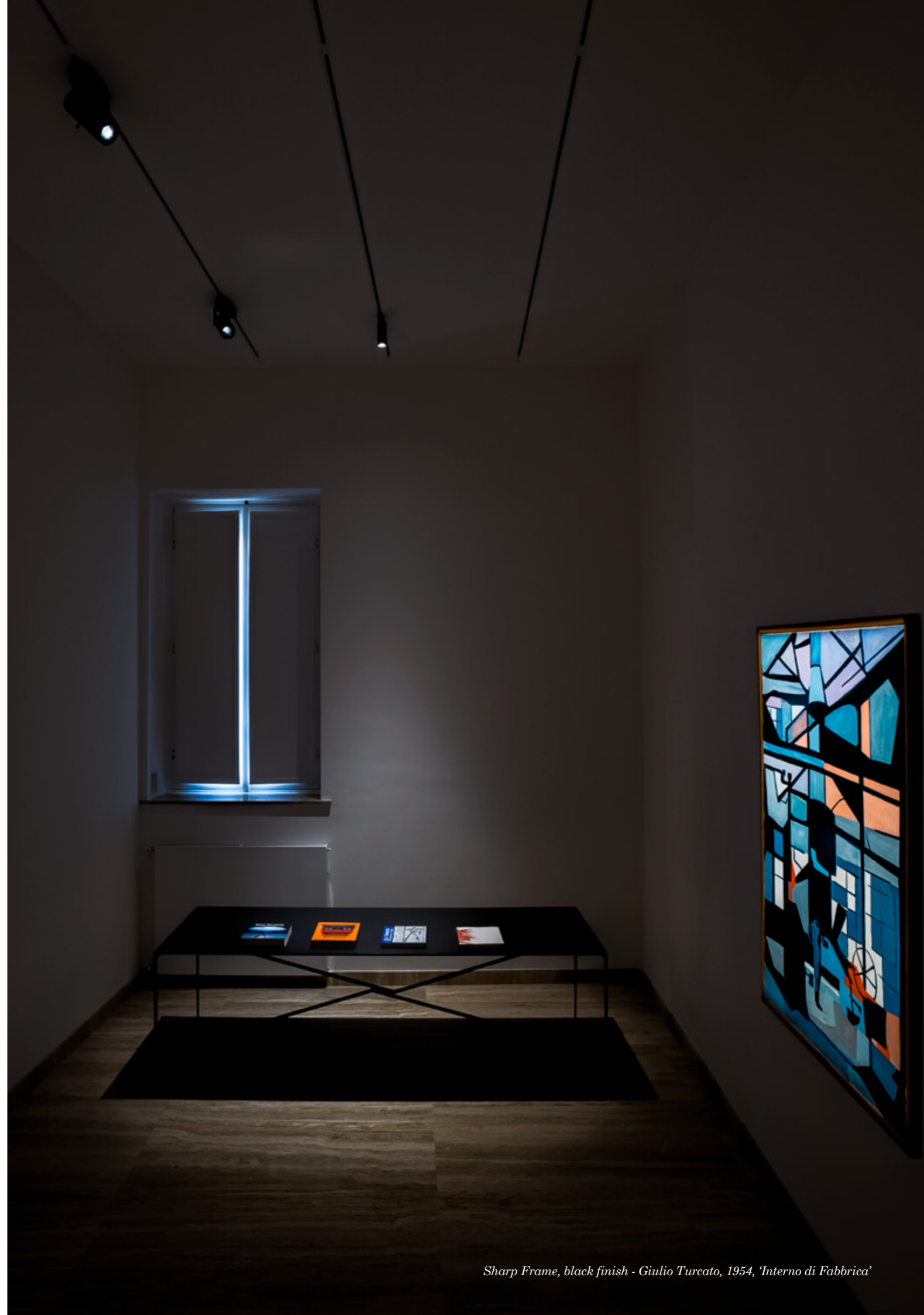

FRAME OPTIC

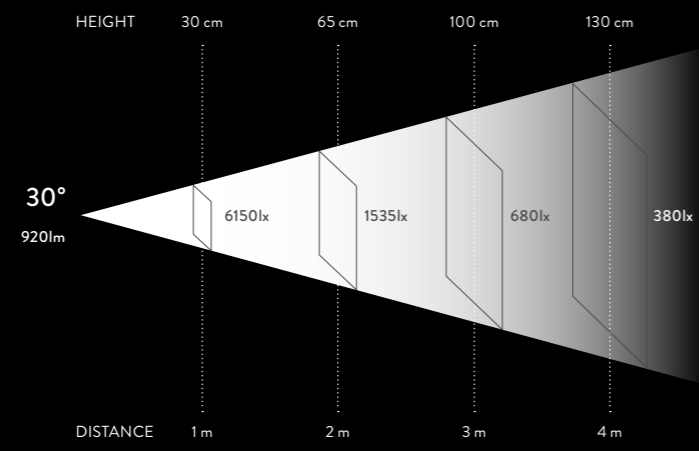
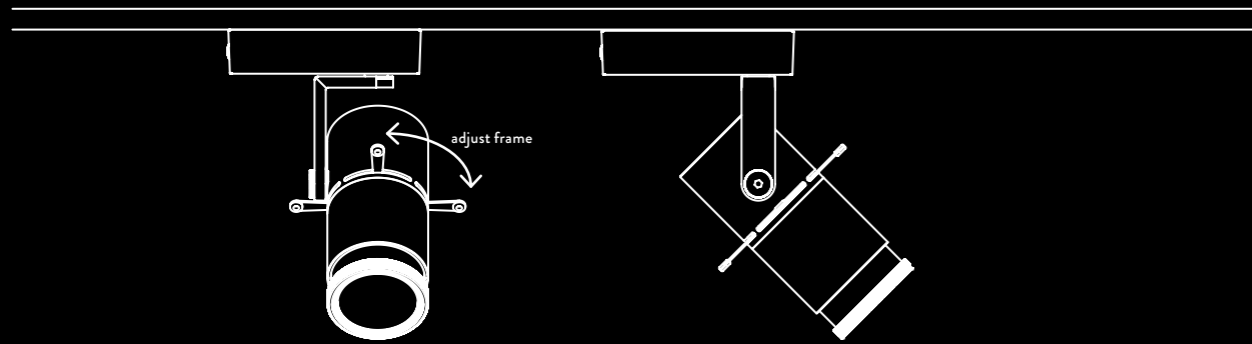

Sharp Frame, white finish



Defined edges lens included

CEILING/PENDANT



RECESSED



TRACK 3~230V

version	voltage/current	switching	mounting	finish	code
1m	230V	ON-OFF / TRIAC	ceiling, pendant	white	MTRK0110BI
				black	MTRK0110NE
				white	MTRK0120BI
				black	MTRK0120NE
				white	MTRK0130BI
				black	MTRK0130NE
1m	230V	DALI / 1-10V	ceiling, pendant	white	MTRK0210BI
				black	MTRK0210NE
				white	MTRK0220BI
				black	MTRK0220NE
				white	MTRK0230BI
				black	MTRK0230NE
2m	230V	ON-OFF / TRIAC	ceiling, pendant	white	MTRK0310BI
				black	MTRK0310NE
				white	MTRK0320BI
				black	MTRK0320NE
				white	MTRK0330BI
				black	MTRK0330NE
2m	230V	DALI / 1-10V	ceiling, pendant	white	MTRK0410BI
				black	MTRK0410NE
				white	MTRK0420BI
				black	MTRK0420NE
				white	MTRK0430BI
				black	MTRK0430NE
3m	230V	ON-OFF / TRIAC	ceiling, pendant	white	MTRK0310BI
				black	MTRK0310NE
				white	MTRK0320BI
				black	MTRK0320NE
				white	MTRK0330BI
				black	MTRK0330NE
3m	230V	DALI / 1-10V	ceiling, pendant	white	MTRK0410BI
				black	MTRK0410NE
				white	MTRK0420BI
				black	MTRK0420NE
				white	MTRK0430BI
				black	MTRK0430NE

IP20



Track recessed, black



Track recessed, white

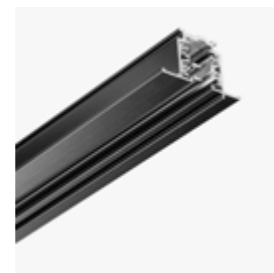

Track ceiling/pendant, black



Track ceiling/pendant, white

DALI ACCESSORY

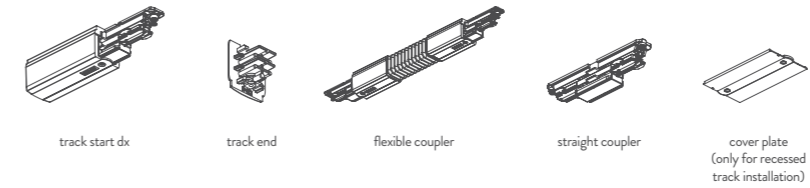

DALI/3PHASE ACCESSORY

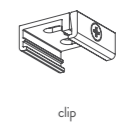

clip

3PHASE ACCESSORY

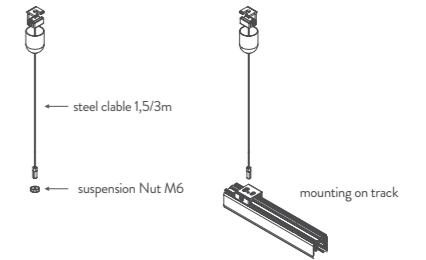
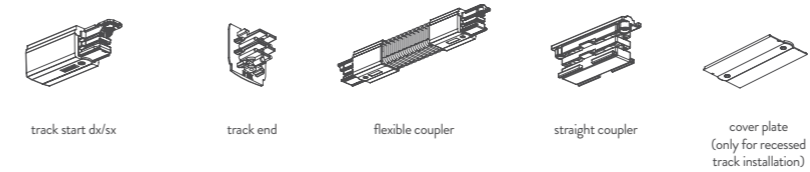

steel cable 1,5/3m

suspension Nut M6

mounting on track

TRACK ACCESSORY

version	voltage/current	switching	mounting	finish	code
Track Start DX	230V	ON-OFF / TRIAC	ceiling, pendant, recessed	white	MTRKADX0BBI
				black	MTRKADX0BNE
Track Start SX	230V	ON-OFF / TRIAC	ceiling, pendant, recessed	white	MTRKASX0BBI
				black	MTRKASX0BNE
Straight Coupler	230V	ON-OFF / TRIAC	ceiling, pendant, recessed	white	MTRKJLOBBI
				black	MTRKJLOBNE
Flexible Coupler	230V	ON-OFF / TRIAC	ceiling, pendant, recessed	white	MTRKJFOBBI
				black	MTRKJFOBNE
Track End	230V	ON-OFF / TRIAC	ceiling, pendant, recessed	white	MTRKEND00BI
				black	MTRKEND00NE
Cover plate	230V	ON-OFF / TRIAC	ceiling, pendant, recessed	white	MTRKCOVBI
				black	MTRKCOVNE
Middle feed	230V	ON-OFF / TRIAC	ceiling, pendant, recessed	white	MTRKAC0BBI
				black	MTRKAC0BNE
Track Start DX	230V	DALI / 1-10V	ceiling, pendant, recessed	white	MTRKADX0ABI
				black	MTRKADX0ANE
Track Start SX	230V	DALI / 1-10V	ceiling, pendant, recessed	white	MTRKASX0ABI
				black	MTRKASX0ANE
Track end	230V	DALI / 1-10V	ceiling, pendant, recessed	white	MTRKEND00BI
				black	MTRKEND00NE
Straight Coupler	230V	DALI / 1-10V	ceiling, pendant, recessed	white	MTRKJLOABI
				black	MTRKJLOANE
Flexible Coupler	230V	DALI / 1-10V	ceiling, pendant, recessed	white	MTRKJFOABI
				black	MTRKJFOANE
Cover plate	230V	DALI / 1-10V	ceiling, pendant, recessed	white	MTRKCOVABI
				black	MTRKCOVANE
Middle feed	230V	DALI / 1-10V	ceiling, pendant, recessed	white	MTRKAC0ABI
				black	MTRKAC0ANE
Clip	230V	DALI / 1-10V	ceiling, pendant	white	MTRKCL00BI
				black	MTRKCL00NE
Steel Cable 1,5m	230V	DALI / 1-10V	ceiling, pendant	white	MTRKAB0015BI
				black	MTRKAB0015NE
Steel Cable 3m	230V	DALI / 1-10V	ceiling, pendant	white	MTRKAB0030BI
				black	MTRKAB0030NE
Suspension nut M6	230V	DALI / 1-10V	ceiling, pendant		MTRKNUT



LED EYE è un mini faretto LED orientabile, dedicato ad un'illuminazione d'accento in interni e in particolar modo, di vetrine e piccoli espositori. Il corpo è in alluminio anodizzato nero e la tige che lo sostiene consente di fissare il faretto a plafone e ne permette l'orientabilità. A seconda delle specifiche necessità di installazione, la luce può essere regolata per ottenere un'illuminazione puntuale.

LED EYE is a small adjustable LED spot suitable for accent lighting in interior applications, particularly suitable for shop displays and small expositions. Black aluminium body and the rod that supports it allows the spot to be fixed and point the light. Depending on the specific installation needs, the light can be adjusted to achieve a precise accent effect.

LED EYE ist ein einstellbarer Mini-LED-Strahler, der für die Akzentbeleuchtung in Innenräumen und insbesondere für Schaukästen und kleine Displays geeignet ist. Gehäuse aus schwarz eloxiertem Aluminium. Der Stab ermöglicht die freie Orientierung des Strahlers und die Installation an Decken. Je nach spezifischen Installationsanforderungen kann das Licht reguliert werden, um eine gezielte Spotbeleuchtung zu ermöglichen.

LED EYE est un mini spot LED orientable, pour un éclairage ponctuel en intérieur et en particulier pour les vitrines et petits présentoirs. Le corps est en aluminium anodisé noir et la tige qui le supporte permet de fixer le projecteur au plafond et de le régler. Selon les besoins spécifiques d'installation, la lumière peut être réglée afin d'obtenir un éclairage ponctuel.



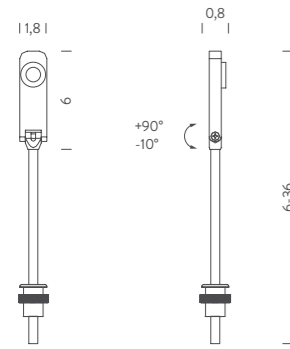

LED EYE

<i>voltage/current</i>	<i>max power</i>	<i>source</i>	<i>flux</i>	<i>optic</i>	<i>CRI</i>	<i>switching</i>	<i>mounting</i>	<i>CCT</i>	<i>finish</i>	<i>code</i>
350mA	4,2W	LED	160lm	40°	90	according to driver	ceiling, table	3000K	black	BFLET401421WAN
<i>note</i>	driver not included (more specifications in table below), orientable spot -10°/+90°, adjustable height 6-36cm, recessed hole Ø 14mm, black anodised finish, series connection									
<i>customizations</i>	1-10V, DALI, DMX, Casambi									

IP40



orientable -10°/+90°

LED EYE DRIVER

<i>version</i>	<i>voltage/current</i>	<i>max power</i>	<i>switching</i>	<i>dimensions cm</i>	<i>code</i>
for 2 spots	350mA	12W	ON-OFF	9,8x3,3x2,2	WALIMLED08350
for 3 spots		17W		12,2x3,8x2,4	WALIMLED12350
		15W	dimnable 1-10V	10,3x6,7x2,1	WALI/DIMM/JOLLY
for 5 spots		25W		12,4x7,9x2,2	WALI/MAXI/JOLLY
<i>note</i>	series connection				





MINIFLUX è una famiglia di sistemi lineari modulari ideali per applicazioni in esterni, adatta ad un'illuminazione d'accento, decorativa e di segnalazione. MINIFLUX è composto da un corpo in profilato in alluminio su cui è posizionata una LED strip 24V DC ad alta emissione. Il sistema si completa con un diffusore cilindrico in policarbonato trasparente o opale, per un'emissione omogenea della luce. Il fissaggio avviene tramite staffe in policarbonato trasparente che permettono l'orientabilità del prodotto. La famiglia è proposta in diverse dimensioni e temperature colore. Per soddisfare particolari necessità progettuali, sono disponibili a richiesta lunghezze su misura.

MINIFLUX is a collection of modular linear systems for outdoor applications, suitable for decorative, accent and signalization lighting. Composed of a high-emission LED strip (24V DC) in an aluminium profile and a transparent or opal polycarbonate cylindrical diffuser for a homogeneous emission of light. Installation realised through transparent polycarbonate clips, which allow light adjustments. Available in numerous lengths and colour temperatures, MINIFLUX is a surprisingly versatile luminaire that has proven especially popular for retail and cove lighting solutions. Bespoke lengths available.

MINIFLUX ist eine Kollektion modularer linearer Systeme für die Innen- und Außenbeleuchtung, die sich vor allem für dekorative, Akzent- und Signal-Beleuchtung eignet. MINIFLUX besteht aus einem hochemittierenden LED-Streifen (24V DC) in einem Aluminiumprofil und einem zylindrischen Diffusor aus transparentem oder opalem Polycarbonat für eine homogene Lichtabstrahlung. Die Installation erfolgt über transparente Polycarbonat-Clips, die die freie Ausrichtung bei der Installation des Leuchtkörpers ermöglichen. In zahlreichen Längen und Farbtemperaturen erhältlich, verkörpert MINIFLUX eine vielseitige Leuchte, die besonders gerne bei Einzelhandel- und Voutenbeleuchtung eingesetzt wird. Maßgeschneiderte Längen für spezielle Projektanforderung sind verfügbar.

MINIFLUX est une famille de systèmes linéaires modulaires pour les applications extérieures, adaptés à l'éclairage décoratif, ponctuel et balisage. Il est composé d'une bande LED à haute émission (24V DC) dans un profilé en aluminium. Diffuseur cylindrique en polycarbonate transparent ou opale pour une émission lumineuse homogène. La fixation est réalisée grâce à des clips en polycarbonate transparent. La collection MINIFLUX est proposée en différentes longueurs et températures de couleur. Pour satisfaire des demandes spécifiques de projet, il peut être fourni sur demande des longueurs sur mesure.



HP - 120°/ASYMMETRIC

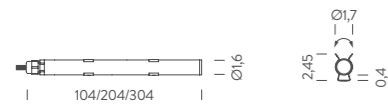

HP PLUS

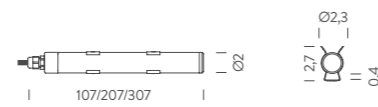

MINIFLUX TRASPARENT

version	voltage/ current	max power	source	flux	optic	CRI	switching	mounting	CCT	finish	code
1m HP	24V DC	16W	linear LED	1486lm	120°	80	according to driver	ceiling/wall	2700K	trasparent polycarbonate	BBOK0910007DPC
					120°				3000K	BBOK0910007WPC	
					1386lm				asymmetric	BBOK0910207WPC	
					1512lm				120°	4000K	BBOK0910007NPC
					1386lm				asymmetric	BBOK0910207NPC	
1m HP PLUS	20W	2600lm	120°	3000K	BBOK0910015WPC						
				120°	4000K	BBOK0910015NPC					
2m HP	32W	2972lm	120°	2700K	BBOK0920007DPC						
				120°	3000K	BBOK0920007WPC					
				2772lm	asymmetric	BBOK0920207WPC					
				3024lm	120°	4000K	BBOK0920007NPC				
				2772lm	asymmetric	BBOK0920207NPC					
2m HP PLUS	40W	5200lm	120°	3000K	BBOK0920015WPC						
				4000K	BBOK0920015NPC						
3m HP	48W	4458lm	120°	2700K	BBOK0930007DPC						
				120°	3000K	BBOK0930007WPC					
				4158lm	asymmetric	BBOK0930207WPC					
				4536lm	120°	4000K	BBOK0930007NPC				
				4158lm	asymmetric	BBOK0930207NPC					
3m HP PLUS	60W	7800lm	120°	3000K	BBOK0930015WPC						
				120°	4000K	BBOK0930015NPC					

note driver and other accessory not included (more specifications on p.190), cable length 2m

customizations CCT 2700K, tube length, 1-10V, DALI, DMX, Casambi



OPAL



MINIFLUX OPAL

version	voltage/ current	max power	source	flux	optic	CRI	switching	mounting	CCT	finish	code
1m	24V DC	15W	linear LED	905lm	diffuse orientable	97	according to driver	ceiling/wall	3000K	opal white	BBOK0910G26WPO
					94	4000K			BBOK0910G26NPO		
2m		30W		1800lm		97			3000K		BBOK0920G26WPO
									94	4000K	BBOK0920G26NPO

note driver and other accessory not included (more specifications on p.190), cable length 2m

customizations CCT 2700K, tube length, 1-10V, DALI, DMX, Casambi



transparent finish

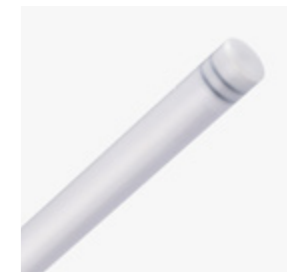

opal white finish



Miniflux Transparent- "Gianfranco Ferré. Sotto un'altra luce: Gioielli ed Ornamenti". Palazzo Madama, Turin

MINIFLUX DRIVER

version	voltage/current	max power	IP	switching	dimensions cm	code
24VDC	IN 100/240VAC - OUT 24VDC	20W	20	ON-OFF	15x4x3	WALIMLED020/24
	IN 100/240VAC - OUT 24VDC	25W	67		14,8x4x3,2	WALIMLED25/24IP
	IN 220/240VAC - OUT 24VDC	60W	20		18x5,2x3	WALIM60W24VIN
	IN 100/240VAC - OUT 24VDC	60W	67		17,2x5,3x3,7	WALIM60W24V
	IN 100/240VAC - OUT 24VDC	80W	20		24,1x4,3x3	WALIM80W24V
	IN 100/240VAC - OUT 24VDC	100W	67		14x6,3x3,2	WALIMLED100/24
	IN 220/240VAC - OUT 24VDC	120W	20		30x4x3	WALIM120W24VIN
	IN 220/240VAC - OUT 24VDC	150W	20		18x6,5x3,1	WALIM150W24VIN
	IN 220/240VAC - OUT 24VDC	150W	67		25x6,8x4,5	WALIMLED150/24
	IN 100/240VAC - OUT 24VDC	240W	67		24,4x7,1x3,8	WALIMLED240/24
	IN 220/240VAC - OUT 24VDC	250W	20		19,5x6,7x3,2	WALIMLED250W24VIN

note for outdoor installation IP connection system not included



CONNECTORS KIT IP68

version	dimensions cm	code
max power 10A (2 poles)	Ø1,4x9	MRIGALIMIP68



WALKLINE è un sistema lineare di illuminazione a LED 24V DC per esterni.

È proposto in due versioni dedicate rispettivamente ad un'illuminazione omogenea, ottenuta tramite una superficie in resina opale o wall-washer, dotato di apposita ottica. La famiglia WALKLINE viene proposta in differenti lunghezze e temperature colore. È dimmerabile 1-10V, DALI o DMX ed il fissaggio avviene tramite cassetta a pavimento inclusa. WALKLINE e WALKLINE WALL-WASHER hanno un elevato indice di resistenza: sono infatti entrambi calpestabili e carrabili. Trovano applicazione in ambientazioni outdoor con necessità di illuminazione di segnalazione o decorativa.

WALKLINE is a walkable, linear LED 24V DC system for outdoor signalization or wall washer lighting. The WALKLINE consists of a naturally anodised aluminium profile with an opal resin coating for homogeneous light emission or with a wall washer optic. Available in various standard lengths. Dimmable 1-10V, DALI or DMX. Recessed box installation included. WALKLINE and WALKLINE WALL WASHER are extremely resistant against scratches, foot and drive traffic and lend themselves for outdoor settings where signalling or decorative lighting is required.

WALKLINE ist ein lineares LED 24V DC Beleuchtungssystem für den Außenbereich. WALKLINE ist ein lineares LED-System für den Außenbereich bestehend aus einem natürlich eloxierten Aluminiumprofil. WALKLINE ist mit einer opalen Harzversiegelung für eine homogene Lichtemission oder einer speziellen WALL-WASHER Optik ausgestattet. In verschiedenen Längen erhältlich. Dimmbar 1-10V, DALI oder DMX. Einbaubox für die Bodeninstallation ist im Lieferumfang enthalten. WALKLINE und WALKLINE WALL-WASHER haben einen hohen Widerstandsindex: sie sind sowohl begehbar als auch befahrbar. Geeignet für den Außenbereich als Signal- oder Dekorationsbeleuchtung.

WALKLINE est un système d'éclairage extérieur à LED linéaire de 24 V CC.

Proposé en deux versions dédiées respectivement à un éclairage homogène obtenu grâce à une surface en résine opale, ou wall-washer équipé d'une optique spécifique. La famille WALKLINE est proposée en différentes longueurs et températures de couleur. Dimmable 1-10V, DALI ou DMX. Installation via le boîtier d'encastrement (inclus). WALKLINE et WALKLINE WALL-WASHER ont un indice de résistance élevé: ils sont à la fois piétonniers et carrossables. Ils trouvent leur application dans les environnements extérieurs pour du balisage ou éclairage décoratif.



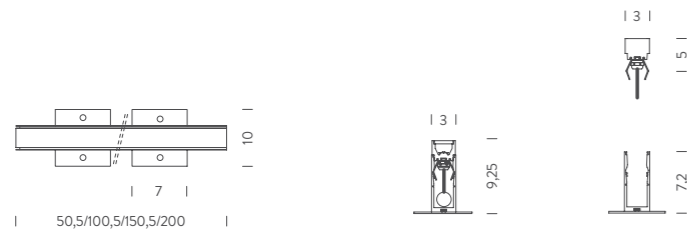

WALKLINE

version	voltage/current	max power	source	flux	optic	CRI	switching	mounting	CCT	finish	code
0,5m	24VDC	7,5W	linear LED	325lm	diffused	90	according to driver	floor recessed	4000K	grey	BWLK0205G26NAA
		7,5W							6000K	BWLK0205G260AA	
1m		15W		650lm					4000K		BWLK0210G26NAA
		15W							6000K	BWLK0210G260AA	
1,5m		22,5W		975lm					4000K		BWLK0215G26NAA
		22,5W							6000K	BWLK0215G260AA	
2m		30W		1300lm					4000K		BWLK0220G26NAA
		30W							6000K	BWLK0220G260AA	

note driver not included (more specifications in the table below), cable length 0,5m, certified 500kg static load, 3500kg dynamic load

customizations body length, 1-10V, DALI, DMX, Casambi, CCT 2700K

IP67 IK10



homogeneous light emission

WALKLINE DRIVER

version	voltage/current	max power	IP	switching	dimensions cm	code
24VDC	IN 220/240VAC - OUT 24VDC	20W	20	ON-OFF	15x4x3	WALIMLED020/24
		25W	67		14,8x4x3,2	WALIMLED25/24IP
		60W	20		18x5,2x3	WALIM60W24VIN
		60W	67		17,2x5,3x3,7	WALIM60W24V
		80W	20		24,1x4,3x3	WALIM80W24V
		100W	67		14x6,3x3,2	WALIMLED100/24
		120W	20		30x4x3	WALIM120W24VIN
		150W	20		18x6,5x3,1	WALIM150W24VIN
		150W	67		25x6,8x4,5	WALIMLED150/24
		240W	67		24,4x7,1x3,8	WALIMLED240/24
		250W	20		19,5x6,7x3,2	WALIMLED250W24VIN

note for outdoor installation IP connection system not included



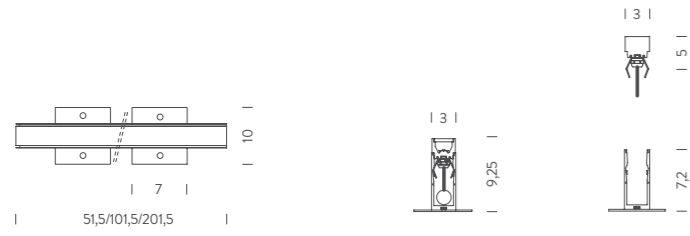

WALKLINE WALL WASHER

version	voltage/current	max power	source	flux	optic	CRI	switching	mounting	CCT	finish	code
0,5m	24VDC	8W	linear LED	625lm	wall washer	90	according to driver	floor recessed	3000K	grey	BWLK0205226WAA
				650lm					4000K		BWLK0205226NAA
1m		16W		1250lm					3000K		BWLK0210226WAA
				1300lm					4000K		BWLK0210226NAA
2m		32W		2500lm					3000K		BWLK0220226WAA
				2600lm					4000K		BWLK0220226NAA
<i>note</i>	driver not included (more specifications on next page), cable length 0,5m, certified 500kg static load, 3500kg dynamic load										
<i>customizations</i>	1-10V, DALI, DMX, Casambi, body lengths										

IP67 IK10



wall washer optic

WALKLINE WALL WASHER DRIVER

version	voltage/current	max power	IP	switching	dimensions cm	code
24VDC	IN 220/240VAC - OUT 24VDC	20W	20	ON-OFF	15x4x3	WALIMLED020/24
		25W	67		14,8x4x3,2	WALIMLED25/24IP
		60W	20		18x5,2x3	WALIM60W24VIN
		60W	67		17,2x5,3x3,7	WALIM60W24V
		80W	20		24,1x4,3x3	WALIM80W24V
		100W	67		14x6,3x3,2	WALIMLED100/24
		120W	20		30x4x3	WALIM120W24VIN
		150W	20		18x6,5x3,1	WALIM150W24VIN
		150W	67		25x6,8x4,5	WALIMLED150/24
		240W	67		24,4x7,1x3,8	WALIMLED240/24
		250W	20		19,5x6,7x3,2	WALIMLED250W24VIN

note for outdoor installation IP connection system not included



WALKWAY è un faretto LED dalle ridotte dimensioni, dedicato alle applicazioni in esterni.

È proposto con corpo in ottone cromato satinato ed è dotato di lente asimmetrica, con un'apertura angolare di circa 140° che consente di ottenere un gradevole effetto di illuminazione decorativa e di segnalazione. WALKWAY è disponibile in due temperature colore e su richiesta, a fronte di particolari necessità specifiche di progetto, è possibile richiedere una differente finitura. Il fissaggio a parete avviene tramite molle sagomate in acciaio o cassaforma in ABS (non inclusa).

WALKWAY is a small, recessed LED spot for outdoor applications.

The sanded chromed brass body is equipped with an asymmetrical lens with an angular opening of 140° that creates a pleasant decorative and signaling lighting effect. Available with two colour temperatures, or in bespoke version for particular project requirements. Installation via steel fixing springs or recessed ABS box (not included).

WALKWAY ist ein kleiner LED-Strahler für Außenanwendungen.

Das Gehäuse besteht aus verchromt datiniertem Messing. Der Strahler ist mit einer asymmetrischen Linse mit einer Winkelöffnung von ca. 140° ausgestattet, die ein angenehmes dekorative und signalisierende Akzentlicht erzeugt. WALKWAY ist in den Farbtemperaturen 3000K und 5000K erhältlich. Für spezielle Projektanforderungen können besondere Farbausführungen angefragt werden. Die Wandbefestigung erfolgt mittels Einbaubox aus Kunststoff (nicht im Lieferumfang enthalten) oder mit den Stahlbefestigungsfedern (im Lieferumfang enthalten).

WALKWAY est un spot à LED de petite taille, dédié aux applications extérieures.

Il est proposé avec un corps en laiton chromé satiné, équipé d'une lentille asymétrique, avec une ouverture angulaire d'environ 140° pour un effet lumineux confortable décoratif et de balisage. WALKWAY est disponible en deux températures de couleur et sur demande, en réponse aux besoins spécifiques du projet, il est possible de demander une finition différente. La fixation murale se fait au moyen de ressorts en acier profilés ou de boîtier d'encastrement ABS (non inclus).

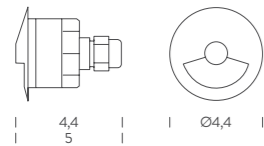

**WALKWAY**

<i>voltage/current</i>	<i>max power</i>	<i>source</i>	<i>flux</i>	<i>optic</i>	<i>CRI</i>	<i>switching</i>	<i>mounting</i>	<i>CCT</i>	<i>finish</i>	<i>code</i>
350mA	1,2W	LEDspot	10lm	asymmetric	70	according to driver	recessed	3000K	grey	BLUX0201217WCS
			12lm		90			5000K		BLUX02012170CS
<i>note</i>	driver not included (more specifications on next page), cable length 1m, series connection									
<i>customizations</i>	1-10V, DALI, DMX, Casambi, finishes, CCT 2700K									

IP65



sanded chromed brass

WALKWAY DRIVER

<i>version</i>	<i>voltage/current</i>	<i>max power</i>	<i>IP</i>	<i>switching</i>	<i>dimensions cm</i>	<i>code</i>
for 1 spot	350mA	1,4W	66	ON-OFF	3,8x3x2,3	WALIMLED01350
for 3 spots		4W	20		4x4x2,1	WALIMLED03350
for 3-8 spots		12W			9,8x3,3x2,2	WALIMLED08350
for 3-12 spots		17W			12,2x3,8x2,4	WALIMLED12350
for 12 spots		15W		dimnable 1-10V	10,3x6,7x2,1	WALI/DIMM/JOLLY
<i>note</i>	for outdoor installation IP connection system not included					

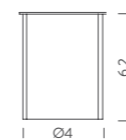
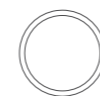
**ACCESSORIES**

<i>version</i>	<i>finish</i>	<i>dimensions cm</i>	<i>code</i>
RECESSED BOX for 1 spot	ABS	Ø4x6,2	BLUXCASSA1
<i>note</i>	installation BOX, not IP rated		



WALKBY è una nuova famiglia di lampade ad incasso a parete per applicazioni in esterni.

È proposto in due dimensioni e potenze. Corpo in alluminio con finitura dark grey e ottica asimmetrica arretrata per garantire un'emissione omogenea ed una perfetta illuminazione decorativa e di segnalazione. WALKBY è comprensivo di alimentatore integrato. Il fissaggio avviene tramite cassettaforma in policarbonato inclusa.

WALKBY is a new family of wall recessed lamp for outdoor applications available in two sizes and different lumen packages. The dark grey aluminium body and asymmetric dark-light optic allow a homogeneous light dissipation ideal for accent and decorative lighting.

Installation through a polycarbonate recessed box and driver on-board.

WALKBY ist eine neue Familie von Wandeinbauleuchten für Außenanwendungen. WALKBY ist in zwei Größen mit verschiedenen Lumenpaketen erhältlich. Der dunkelgraue Aluminiumkörper und die asymmetrische Dark-Light-Optik ermöglichen eine homogene Lichtabstrahlung, ideal für Akzent- und Dekorationsbeleuchtung. WALKBY hat eine integrierte Stromversorgung und wird mit einer Polycarbonat-Schalung (im Lieferumfang enthalten) installiert.

WALKBY est une nouvelle famille d'appliques à encastrer pour les applications extérieures.

Il est proposé en deux dimensions et puissances.

Corps en aluminium avec finition gris foncé et optique asymétrique en retrait assurant une émission homogène et un éclairage parfait décoratif ou de balisage. Alimentation intégrée. La fixation se fait grâce à un boîtier d'encastrement en polycarbonate inclus.

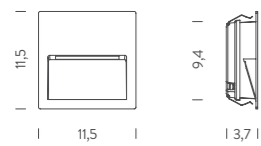

**WALKBY**

<i>voltage/current</i>	<i>max power</i>	<i>source</i>	<i>flux</i>	<i>optic</i>	<i>CRI</i>	<i>switching</i>	<i>mounting</i>	<i>CCT</i>	<i>finish</i>	<i>code</i>
220/240V	4W	LED Spot	180lm	direct asymmetric	> 80	ON-OFF	wall	3000K	dark grey	MWBY4101038WGA
<i>note</i>		recessed box included, driver included								

IP65

dark grey finish

**WALKBY PLUS**

<i>voltage/current</i>	<i>max power</i>	<i>source</i>	<i>flux</i>	<i>optic</i>	<i>CRI</i>	<i>switching</i>	<i>mounting</i>	<i>CCT</i>	<i>finish</i>	<i>code</i>
220/240V	8W	LED Spot	330lm	direct asymmetric	> 80	ON-OFF	wall	3000K	dark grey	MWBY41P1038WGA
<i>note</i>		recessed box included, driver included								

IP65

dark grey finish





La collezione RIGA racchiude una selezione di LED strips flessibili per esterni, particolarmente adatta ad un'illuminazione decorativa e di segnalazione. Ogni RIGA è costituito da un nastro LED a 24V DC inguainato in un profilo in PVC bianco e incapsulato in una resina poliuretana trasparente o opale, per un'emissione omogenea della luce. Grazie alle possibilità di curvatura del prodotto inoltre, RIGA OPAL permette un'emissione luminosa laterale, frontale o multi-direzionale. La flessibilità di RIGA lo rendono il prodotto perfetto anche per effetti di luce cove-lighting in ambientazioni residenziali e pubbliche. La collezione RIGA è proposta in differenti lunghezze e temperature colore. Il fissaggio avviene tramite staffette (incluse). È estremamente resistente agli agenti atmosferici e con un eccellente grado di stabilità, se esposta a raggi UV.

RIGA is a product family with a selection of flexible LED strips for outdoor use, particularly suitable for decorative and signalling lighting. RIGA is composed of a 24V LED strip embedded in a white PVC profile and encapsulated in a transparent or opal polyurethane resin. RIGA OPAL version emits a homogeneous diffused light either from the front, the side or multi-directional depending on the curvature of the LED strip. RIGA's flexibility and IP68 rating makes the collection perfectly suitable for cove-lighting effects in residential and public spaces, both indoor and outdoor. Extremely resistant to any weather condition and with excellent stability against UV rays. RIGA collection is available in numerous standard lengths and colour temperatures, or bespoke on demand. Clips for installation are included.

Die RIGA-Kollektion besteht aus flexiblen LED-Streifen für den Außenbereich, die sich besonders für dekorative und Signal-Beleuchtung eignen. RIGA bestehen aus 24V DC LED-Streifen in einem weißen PVC-Profil und ist transparentem oder opalem Polyurethanharz versiegelt, somit witterungsbeständig und mit einem hervorragendem Schutz gegen UV-Strahlen.

Die verschiedenen Versionen des RIGA OPAL mit seitlicher, frontaler oder multi-direktionaler Lichtausstrahlung sind biegsam und passen sich je nach Projektanforderungen gut an.

Die RIGA-Kollektion ist in verschiedenen Längen und Farbtemperaturen erhältlich.

Befestigungsklammern für die Installation sind im Lieferumfang enthalten.

Die Installation kann mit Halterungen (im Lieferumfang enthalten) erfolgen.

La collection RIGA réunit une sélection de LED strip flexibles pour l'extérieur, particulièrement adaptés à l'éclairage décoratif et de balisage. Chaque RIGA est constitué d'une bande LED 24V DC gainée d'un profil en PVC blanc et encapsulée dans une résine polyuréthane transparente ou opale, pour une émission lumineuse homogène.

De plus, grâce à la possibilité de courbure du produit, RIGA OPAL permet une émission lumineuse latérale, frontale ou multidirectionnelle. La polyvalence de RIGA en fait le produit parfait également pour les effets d'éclairage de corniche dans les environnements résidentiels et publics. La collection RIGA est proposée en différentes longueurs et températures de couleur. La fixation se fait avec des supports (inclus). Il est extrêmement résistant aux agents atmosphériques et avec un excellent degré de stabilité si exposé aux rayons UV.



TRASPARENT

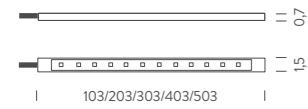

OPAL

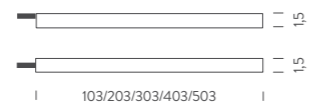

RIGA OPAL FRONT LIGHT

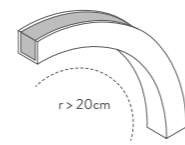

RIGA OPAL SIDE LIGHT

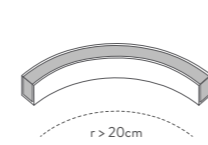

BRACKETS (included)



RIGA

RIGA TRASPARENT

version	voltage/ current	max power	source	flux	optic	CRI	switching	mounting	CCT	finish	code
1m	24VDC	9,6W	flex linear LED	1400lm	direct 120°	85	acc.to driver	ceiling/wall	2700K	white	MRIG0910G35DRE
2m		19,2W		2800lm							MRIG0920G35DRE
3m		28,8W		4200lm							MRIG0930G35DRE
4m		38,4W		5600lm							MRIG0940G35DRE
5m		48W		7000lm							MRIG0950G35DRE

RIGA OPAL

1m- front light	24VDC	9,6W	flex linear LED	510lm	diffused	85	acc.to driver	ceiling/wall	3000K	white	MRIG0910G35WFL
1m- side light											MRIG0910G35WSL
1m- front light				600lm					4000K		MRIG0910G35NFL
1m- side light											MRIG0910G35NSL
2m- front light		19,2W		1020lm					3000K		MRIG0920G35WFL
2m- side light											MRIG0920G35WSL
2m- frontlight				1200lm					4000K		MRIG0920G35NFL
2m- side light											MRIG0920G35NSL
3m- front light		28,8W		1530lm					3000K		MRIG0930G35WFL
3m- side light											MRIG0930G35WSL
3m- front light				1800lm					4000K		MRIG0930G35NFL
3m- side light											MRIG0930G35NSL
4m- front light		38,4W		2040lm					3000K		MRIG0940G35WFL
4m- side light											MRIG0940G35WSL
4m- front light				2400lm					4000K		MRIG0940G35NFL
4m- side light											MRIG0940G35NSL
5m- front light		48W		2550lm					3000K		MRIG0950G35WFL
5m- side light											MRIG0950G35WSL
5m- front light				3000lm					4000K		MRIG0950G35NFL
5m- side light											MRIG0950G35NSL

note driver not included (more specifications on p.218), cable length 2m

customizations body length, 1-10V, DALI, DMX, Casambi, CCT 2700K

IP68



riga opal front light



riga opal side light



riga transparent

3D

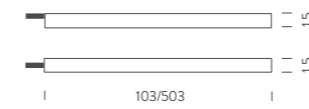

BRACKETS (included)



RIGA 3D

version	voltage/ current	max power	source	flux	optic	CRI	switching	mounting	CCT	finish	code
1m- 3D	24VDC	8W	flexible linear LED	500lm/m	diffused orientable	>80	acc.to driver	ceiling/wall	2800K	opal white	MRIG0910G55D3D
		8W							4400K		MRIG0910G55N3D
5m- 3D		40W							2800K		MRIG0950G55D3D
		40W							4400K		MRIG0950G55N3D

note driver not included (more specifications on p.218), cable length 0,5m

customizations body length, 1-10V, DALI, DMX, Casambi

IP67



riga opal/3d

RIGA DRIVER

version	voltage/current	max power	IP	switching	dimensions cm	code
24VDC	IN 100/240VAC - OUT 24VDC	20W	20	ON-OFF	15x4x3	WALIMLED020/24
		25W	67		14,8x4x3,2	WALIMLED25/24IP
		60W	20		18x5,2x3	WALIM60W24VIN
		60W	67		17,2x5,3x3,7	WALIM60W24V
		80W	20		24,1x4,3x3	WALIM80W24V
		100W	67		14x6,3x3,2	WALIMLED100/24
		120W	20		30x4x3	WALIM120W24VIN
		150W	20		18x6,5x3,1	WALIM150W24VIN
		150W	67		25x6,8x4,5	WALIMLED150/24
		240W	67		24,4x7,1x3,8	WALIMLED240/24
		250W	20		19,5x6,7x3,2	WALIMLED250W24VIN

note for outdoor installation IP connection system not included



ACCESSORIES

version	voltage/current	dimensions cm	code
CONNECTOR KIT IP 68	max 10A (2poles)	Ø1,4x9	MRIGALIMIP68
END CAP (riga transparent)		1,65x0,95x1,1	MRIGTAPPO

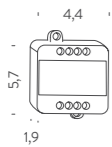

DIMMER INTERFACE

dimensions	code
4,4x1,9x5,7	WDIMDALIHP
<i>included options</i>	1-10V 0-10V PUSH DALI



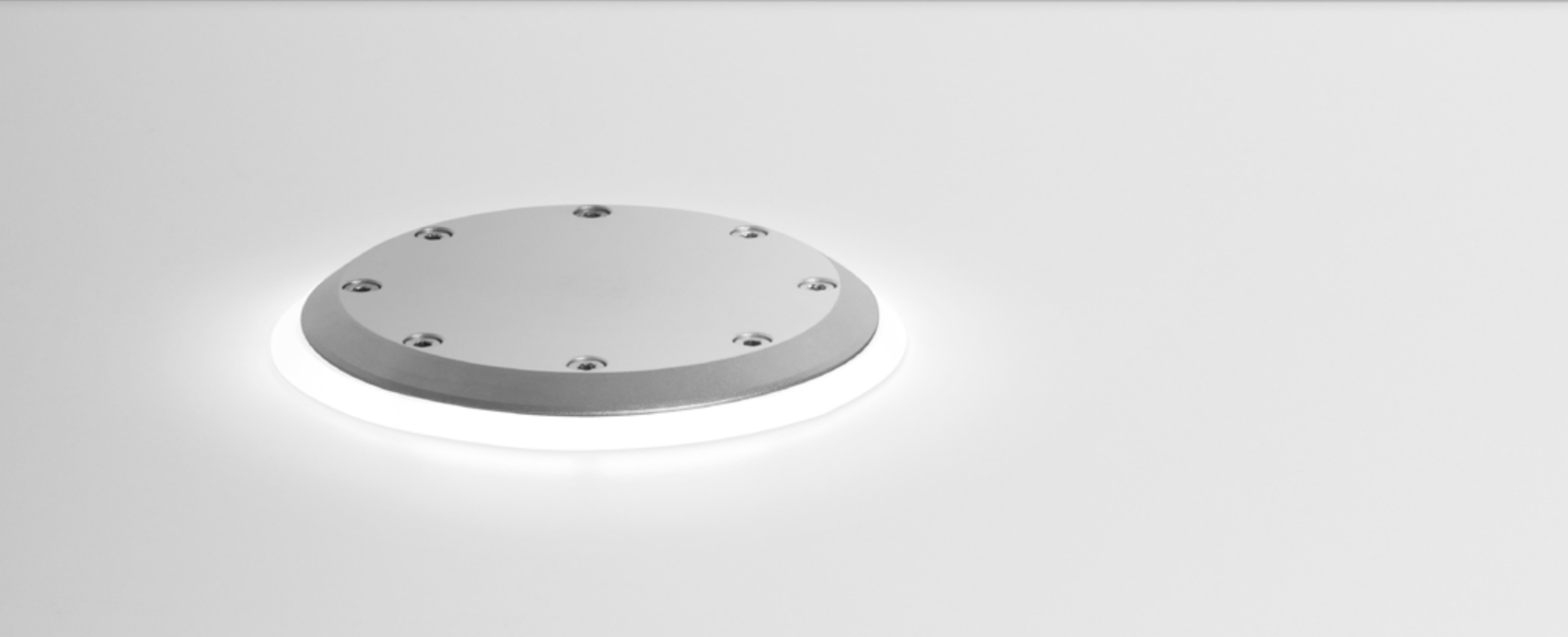

SKILLED è un apparecchio ad incasso per esterni. È carrabile fino a 3000kg e trova quindi principale applicazione in parcheggi e camminamenti. È realizzato con un corpo in alluminio, ottone cromato e policarbonato. SKILLED consente un effetto di luce radente bianca, realizzata attraverso un diffusore in policarbonato trasparente. A fronte di particolari necessità progettuali, è possibile ottenere un'emissione laterale con luce blu/verde/ambra/rossa o RGB. Il grado IP67 consente inoltre un alto livello di protezione da infiltrazioni di polvere e di acqua. Fissaggio tramite cassaforma in alluminio (non inclusa).

SKILLED is a recessed spot for outdoor use. The aluminium, chromed brass and polycarbonate body is weight resistant up to 3000kg, making it especially suitable for the illumination of parking areas and walking paths. Radiant white light effect created by a clear polycarbonate diffuser. Bespoke solutions with blue/green/amber/red or RGB can be requested on demand to meet specific project requirements. IP67 rating, making it completely dust- and water-resistant. Aluminium box for installation not included.

SKILLED ist eine Einbauleuchte für den Außenbereich. Bis 3000 kg belastbar und somit prinzipiell für Parkplätze und Gehwege geeignet. Aluminiumgehäuse, verchromtes Messing und Polycarbonat. Weißes Streiflicht dank einer durchsichtigen Polycarbonatscheibe (auf Anfrage auch in blau / grün / bernstein / rot oder RGB erhältlich). IP67 Schutz gegen Eindringen von Staub und Wasser. Befestigung durch Aluminium-Schalung (nicht im Lieferumfang enthalten).

SKILLED est un luminaire encastré pour une utilisation en extérieur. Il est carrossable jusqu'à 3000 kg et est donc principalement utilisé dans les parkings et les allées. Il est fabriqué avec un corps en aluminium, laiton chromé et polycarbonate. SKILLED permet un effet de lumière rasante blanche, créée à travers un disque en polycarbonate transparent.

Face à des besoins particuliers de projet, il est possible d'obtenir une émission latérale avec une lumière bleue / verte / ambre / rouge ou RGB. Le degré IP67 permet également un haut niveau de protection contre les infiltrations de poussière et d'eau. Fixation par boîtier d'encastrement en aluminium (non inclus).



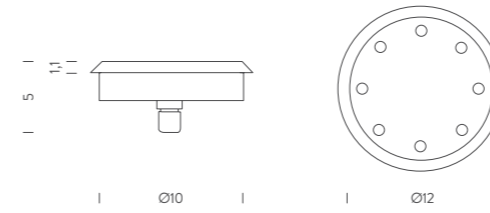

SKILLED

voltage/current	max power	source	flux	optic	CRI	switching	mounting	CCT	finish	code
24VDC	2W	LED spot	20lm	asymmetric	80	according to driver	recessed	6000K	grey	BSKL0212G310CS
<i>note</i>		driver not included, recessed box not included (more specifications in the table below), cable length 1m, certified 500kg static load, 3000kg dynamic load								
<i>customizations</i>		1-10V, DALI, DMX, Casambi, RGB								

IP67

SKILLED DRIVER

version	voltage/current	max power	IP	switching	dimensions cm	code				
24VDC	IN 100/240VAC - OUT 24VDC	25W	67		14,8x4x3,2	WALIMLED25/24IP				
	IN 100/240VAC - OUT 24VDC	60W	67		17,2x5,3x3,7	WALIM60W24V				
	IN 100/240VAC - OUT 24VDC	100W	67		14x6,3x3,2	WALIMLED100/24				
	IN 220/240VAC - OUT 24VDC	150W	67		25x6,8x4,5	WALIMLED150/24				
	IN 100/240VAC - OUT 24VDC	240W	67		24,4x7,1x3,8	WALIMLED240/24				
<i>note</i>		for outdoor installation IP connection system not included								

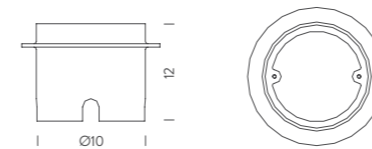

ACCESSORY

version	finish	dimensions cm	code
RECESSED BOX for 1 spot	aluminium	Ø10x12	QBOXSKILL1

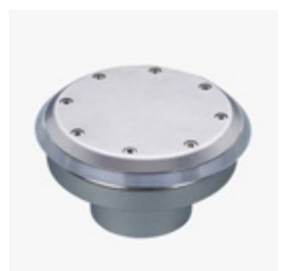

grey finish



KIROPS è uno spot downlight a plafone per applicazioni in esterni.

Il corpo è realizzato in alluminio anodizzato verniciato grigio ed è equipaggiato con 1 COB LED ad alta resa. KIROPS è proposto con due potenze, 14W con un UGR<19 che permette un'illuminazione senza abbagliamento e 19W. La famiglia KIROPS è proposta inoltre con due temperature colore e fasci ottici per un effetto di luce d'accento più o meno concentrata. L'alimentatore remoto (ON/OFF) è incluso.

KIROPS is a surface downlight for outdoor applications.

The anodized aluminium body projector is equipped with a high-emission LED. KIROPS is available in a 14W version with a UGR<19 to reduce glare, and 19W variant, with two colour temperatures and beam angles. Integrated driver (ON-OFF) included.

KIROPS ist ein Deckeneinbau-Downlight für Außenanwendungen. Grau lackiertes Gehäuse aus eloxiertem Aluminium. KIROPS ist mit einem hocheffizienten COB-LED ausgestattet wird mit zwei unterschiedlichen Leistungsstärken angeboten: 14W mit einer blendfreien Beleuchtung (UGR<19) und 19W. Die KIROPS-Familie ist in zwei Farbtemperaturen und optischen Ausstrahlungen angeboten, für einen mehr oder weniger konzentrierten Akzentbeleuchtungseffekt. Ferngesteuertes Vorschaltgerät (ON/OFF) ist im Lieferumfang enthalten.

KIROPS est un plafonnier en saillie destiné aux applications extérieures.

Le corps est en aluminium anodisé peint en gris et est équipé d'une LED COB haute performance. KIROPS est proposé avec deux puissances, 14W avec un UGR <19 qui permet un éclairage sans éblouissement, et 19W. La famille KIROPS est également proposée avec deux températures de couleur et des faisceaux optiques pour un effet d'éclairage ponctuel plus ou moins concentré. L'alimentation déportée (ON / OFF) est incluse.

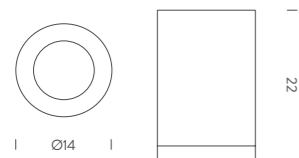

**KIROPS CEILING**

<i>voltage/current</i>	<i>max power</i>	<i>source</i>	<i>flux</i>	<i>optic</i>	<i>CRI</i>	<i>switching</i>	<i>mounting</i>	<i>CCT</i>	<i>finish</i>	<i>code</i>
220/240V	14W	LED spot	1500lm	21°	80	ON-OFF	ceiling	3000K	grey	MKIR0901502WGP
				44°						MKIR0901802WGP
	19W		2000lm	21°						MKIR0902502WGP
				44°						MKIR0902802WGP
	14W		1500lm	21°				4000K		MKIR0901502NGP
				44°						MKIR0901802NGP
	19W		2000lm	21°						MKIR0902502NGP
				44°						MKIR0902802NGP

note driver included, UGR<19

customizations CCT 2700K, finish

☐ IP65





DRAGSTER-T è uno spot downlight da incasso per interni.

È dotato di un LED ad alta resa collocato all'interno di un corpo in alluminio con alettature posteriori. Frontale esterno in alluminio verniciato bianco (RAL 9016). DRAGSTER-T è proposto in due versioni: con ottica a filo e con ottica arretrata «dark-light» per evitare l'abbagliamento. Sono disponibili due temperature colore e tre differenti fasci ottici per un'illuminazione generale o d'accento. Su richiesta è dimmerabile 1-10V e DALI. Trova applicazione sia in ambienti residenziali, sia pubblici.

DRAGSTER-T is a recessed downlight for interior spaces.

Equipped with a high emission LED installed in an aluminium body with fins on the backside. Decorative rim made of varnished white aluminium (RAL 9016). Available in two versions: with a standard optic and with an anti-glare "dark light" optic. Proposed in two colour temperatures and three optic beams, ideal for general or accent lighting for residential and public spaces. Dimmable 1-10V and DALI on request.

DRAGSTER-T ist ein Einbaupunkt-Downlight für Innenräume.

Ein hocheffizientes LED ist in dem Aluminiumgehäuse mit rückseitigen Lamellen untergebracht.

Äußere Frontplatte aus weiß lackiertem Aluminium (RAL 9016).

DRAGSTER-T ist in zwei Ausführungen erhältlich: mit bündiger Optik und mit versenkter «Dark-Light»-Optik zur Vermeidung von Blendung. Für die Allgemein- oder Akzentbeleuchtung stehen zwei Farbtemperaturen und drei verschiedene optische Ausstrahlungen zur Verfügung.

Dimmbar 1-10V und DALI auf Anfrage. Speziell für Wohnbereiche und für öffentliche Räume geeignet.

DRAGSTER-T est un encastré indoor.

Il dispose d'une LED haute performance logée dans un corps en aluminium avec des ailettes postérieures. Façade extérieure en aluminium peint en blanc (RAL 9016). DRAGSTER-T est proposé en deux versions: avec optique standard et avec optique en retrait « dark-light » pour éviter l'éblouissement. Deux températures de couleur et trois faisceaux optiques différents sont disponibles pour un éclairage général ou ponctuel.

Sur demande, il est dimmable 1-10V et DALI. Il trouve une application dans les espaces résidentiels et publics.



DRAGSTER-T

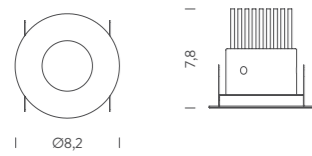

DRAGSTER-T/DARK LIGHT OPTIC

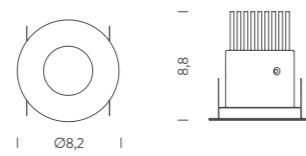

DRAGSTER-T

voltage/current	max power	source	flux	optic	CRI	switching	mounting	CCT	finish	code
IN 36V - 350mA	13W	LED spot	950lm	21°	90	according to driver	recessed	3000K	white	MDRGT101502WBO
				35°						MDRGT101802WBO
				50°						MDRGT101102WBO
			1000lm	21°	4000K	MDRGT101502NBO				
				35°		MDRGT101802NBO				
				50°		MDRGT101102NBO				

DARK-LIGHT OPTIC

IN 36V - 350mA	13W	LED spot	850lm	21°				3000K		MDRGTD01502WBO
				35°						MDRGTD01802WBO
				50°						MDRGTD01102WBO
			900lm	21°	4000K	MDRGTD01502NBO				
				35°		MDRGTD01802NBO				
				50°		MDRGTD01102NBO				

note driver not included (more specifications in the table below), recessed hole Ø 67mm, depth 150mm, cable length 1m, varnished white aluminium (RAL 9016), springs for mounting included
customizations DALI, DMX, Casambi

IP40



dark light optic

DRAGSTER-T DRIVER

version	voltage/current	max power	switching	dimensions cm	code
for 1 spot	350mA	17W		12,2x3,8x2,4	WALIMLED12350
for 1 spots		15W	dimnable 1-10V	10,3x6,7x2,1	WALI/DIMM/JOLLY



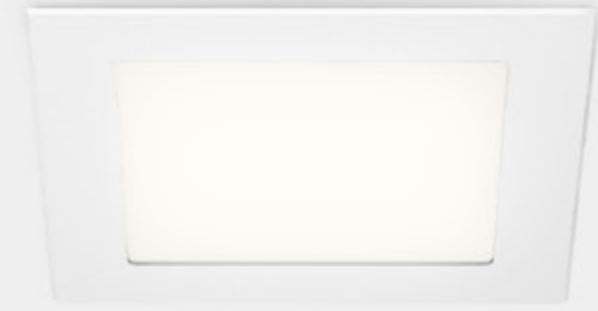
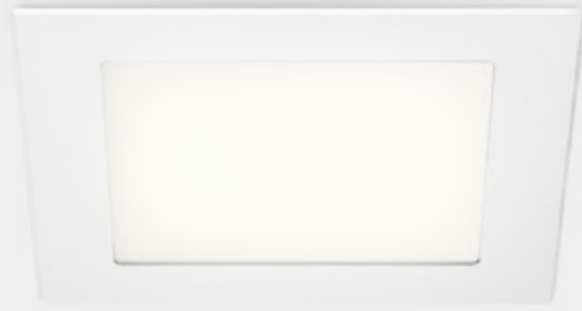

GILDOR è uno spot downlight da incasso per interni. Finitura frontale in alluminio verniciato bianco (RAL 9016) e corpo in alluminio all'interno del quale è collocato un LED ad alta resa. A seconda delle necessità di illuminazione, GILDOR è proposto in due potenze rispettivamente da 19W e 26W. La sorgente luminosa è coperta da uno schermo diffondente opale che consente un'emissione omogenea della luce. GILDOR è disponibile con due temperature colore e dimmerabile 1-10V e DALI. Il fissaggio avviene tramite molle in acciaio (incluse).

GILDOR is a recessed downlight for interior applications. Frontal finish painted white aluminium (RAL 9016) and body in aluminium equipped with a high emission LED. Depending on project needs, GILDOR is proposed with two power packages, 19W and 26W. The source is covered by an opal screen to allow a homogeneous lighting emission. GILDOR is available with different colour temperatures and is dimmable 1-10V and DALI. Fixing through steel springs included.

GILDOR ist ein Einbaudownlight für den Innenbereich. Weiss-lackierte Front (RAL 9016), Aluminiumgehäuse mit einem Hochleistungs-LED. GILDOR in zwei Wattagen, 19W bzw. 26W, und zwei Farbtemperaturen, 3000K oder 4000K, erhältlich. Ein opaler Schirm erlaubt eine homogene Lichtemission. 1-10V und DALI dimmbar. Befestigung mit Stahlfedern (im Lieferumfang enthalten).

GILDOR est un encastré indoor. Finition frontale en aluminium laqué blanc (RAL 9016) et corps en aluminium avec LED haute performance. En fonction des besoins d'éclairage, GILDOR est proposé en deux puissances respectivement de 19W et 26W. La source lumineuse est recouverte d'un écran diffusant opale qui permet une émission de lumière homogène. GILDOR est disponible avec deux températures de couleur et dimmable 1-10V et DALI. La fixation se fait avec des ressorts en acier (inclus).

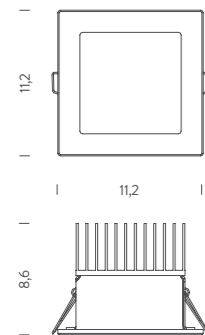

**GILDOR**

<i>voltage/current</i>	<i>max power</i>	<i>source</i>	<i>flux</i>	<i>optic</i>	<i>CRI</i>	<i>switching</i>	<i>mounting</i>	<i>CCT</i>	<i>finish</i>	<i>code</i>
IN 36V - 500mA	19W	LED spot	1000lm	diffused	> 80	according to driver	recessed	3000K	white	MGIL0101G02WBO
IN 36V - 700mA	26W		1500lm							MGIL0102G02WBO
IN 36V - 500mA	19W		1000lm					4000K		MGIL0101G02NBO
IN 36V - 700mA	26W		1500lm							MGIL0102G02NBO
<i>note</i>	driver not included (more specifications in the table below), recessed hole 100x100mm, depth 150mm, cable length 1m, varnished white aluminium (RAL 9016), springs for mounting included									
<i>customizations</i>	DALI, DMX, Casambi									

 **IP40**

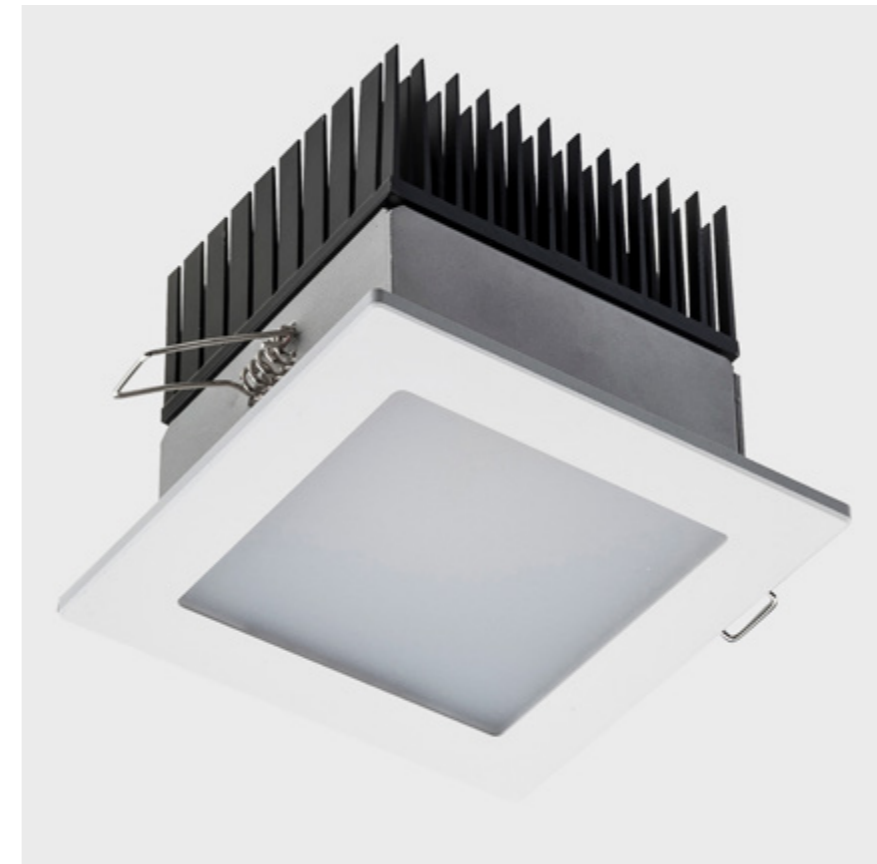

heat dissipation

**GILDOR DRIVER**

<i>version</i>	<i>voltage/current</i>	<i>max power</i>	<i>switching</i>	<i>dimensions cm</i>	<i>code</i>
for 1 spot	500mA	26W	dimnable 1-10V	10,3x6,7x2,1	WALI/DIMM/JOLLY
for 1 spot	700mA	50W	dimnable 1-10V	12,4x7,9x2,2	WALI/MAXI/JOLLY

INDEX

pag	product	variation	codes					
108	ALICUDI	RECESSED EDGE	ALI LW2 63	ALI LN2 63	ALI LW3 63	ALI LN3 63		
		RECESSED TRIM	ALT LW2 63	ALT LN2 63	ALT LW3 63	ALT LN3 63		
76	CAPRI	DIMMABLE TRIAC	CAP LW2 81	CAP LN2 81	CAP LW3 81	CAP LN3 81		
		DIMMABLE 0-10V	CAP LW2 82	CAP LN2 82	CAP LW3 82	CAP LN3 82		
		DIMMABLE DALI	CAP LW2 83	CAP LN2 83	CAP LW3 83	CAP LN3 83		
77	CAPRI CEILING	DIMMABLE TRIAC	CAP LW2 41	CAP LN2 41	CAP LW3 41	CAP LN3 41		
		DIMMABLE 0-10V	CAP LW2 42	CAP LN2 42	CAP LW3 42	CAP LN3 42		
		DIMMABLE DALI	CAP LW2 43	CAP LN2 43	CAP LW3 43	CAP LN3 43		
235	DRAGSTER-T		MDRGT010502WBO	MDRGT010802WBO	MDRGT010102WBO	MDRGT010502NBO	MDRGT010802NBO	MDRGT010102NBO
		DARK LIGHT OPTIC	MDRGT010502WBO	MDRGT010802WBO	MDRGT010102WBO	MDRGT010502NBO	MDRGT010802NBO	MDRGT010102NBO
70	ELBA	DIMMABLE TRIAC	ELB LW2 81	ELB LN2 81	ELB LW3 81	ELB LN3 81		
		DIMMABLE 0-10V	ELB LW2 82	ELB LN2 82	ELB LW3 82	ELB LN3 82		
74	ELBA CEILING	DIMMABLE TRIAC	ELB LW2 41	ELB LN2 41	ELB LW3 41	ELB LN3 41		
		DIMMABLE 0-10V	ELB LW2 42	ELB LN2 42	ELB LW3 42	ELB LN3 42		
90	FLEX CEILING	FIXED OPTIC	BFLE0401F2IWAN	BFLE040142IWAN	BFLE0401F2INAN	BFLE040142INAN		
			BFLE040142INAO	BFLE040142IWAO	BFLE0401F2INAO	BFLE0401F2IWAO		
			BFLE040142INAA	BFLE040142IWAA	BFLE0401F2INAA	BFLE0401F2IWAA		
			BFLE040142INAB	BFLE040142IWAB	BFLE0401F2INAB	BFLE0401F2IWAB		
		ZOOM OPTIC	BFLE040192IWAN	BFLE040192INAN				
90	FLEX TRACK	FIXED OPTIC	MFLE5101N2IWAN	MFLE510142IWAN	MFLE5101N2INAN	MFLE510142INAN		
			ZOOM OPTIC	BFLET40142IWAN	MFLE510192INAN			
241	GILDOR		MGIL0101G02WBO	MGIL0101G02NBO	MGIL0102G02WBO	MGIL0102G02NBO		
229	KIROPS CEILING	3000K	MKIRO901502WGP	MKIRO901802WGP	MKIRO902502WGP	MKIRO902802WGP		
		4000K	MKIRO901502NGP	MKIRO901802NGP	MKIRO902502NGP	MKIRO902802NGP		
179	LED EYE	4,2W	BFLET40142IWAN					
116	LIPARI	RECESSED TRIMLESS	LIP LW2 61	LIP LW3 61	LIP LW2 63	LIP LW3 63		
		RECESSED TRIM	LIT LW2 61	LIT LN2 61	LIT LW3 61	LIT LN3 61	LIT LW2 63	LIT LN2 63
150	LUX GARDEN	GREY	BLUG3001N2IWAA	BLUG3001F2IWAA	BLUG3001N2INAA	BLUG3001F2INAA		
		BLACK	BLUG3001N2IWAN	BLUG3001F2IWAN	BLUG3001N2INAN	BLUG3001F2INAN		
		GREEN	BLUG3001N2IWVE	BLUG3001F2IWVE	BLUG3001N2INVE	BLUG3001F2INVE		
124	LUX INDOOR		BLUX0101717WAA	BLUX0101G17WAA	BLUX0101717NAA	BLUX0101G17NAA		
130	LUX OUTDOOR	GREY	BLUX0201F17WCS	BLUX0201417WCS	BLUX0201617WCS	BLUX0201F170CS	BLUX02014170CS	BLUX02016170CS
		WHITE	BLUX0201F17WTF	BLUX0201417WTF	BLUX0201617WTF	BLUX0201F170TF	BLUX02014170TF	BLUX02016170TF
134	LUX R	GREY	BLUR1901N2IWAA	BLUR1901F2IWAA	BLUR1901N2INAA	BLUR1901F2INAA		
		BLACK	BLUR1901N2IWAN	BLUR1901F2IWAN	BLUR1901N2INAN	BLUR1901F2INAN		
146	LUX S	GREY	BLUS1801N2IWAA	BLUS1801F2IWAA	BLUS1801N2INAA	BLUS1801F2INAA		
		BLACK	BLUS1801N2IWAN	BLUS1801F2IWAN	BLUS1801N2INAN	BLUS1801F2INAN		

pag	product	variation	codes					
142	LUX W-D	GREY	BLUW4102N2IWAA	BLUW4102F2IWAA	BLUW4102N2INAA	BLUW4102F2INAA		
		BLACK	BLUW4102N2IWAN	BLUW4102F2IWAN	BLUW4102N2INAN	BLUW4102F2INAN		
138	LUX W-S	GREY	BLUW4101N2IWAA	BLUW4101F2IWAA	BLUW4101N2INAA	BLUW4101F2INAA		
		BLACK	BLUW4101N2IWAN	BLUW4101F2IWAN	BLUW4101N2INAN	BLUW4101F2INAN		
189	MINIFLUX OPAL	15W	BBOK0910G26WPO	BBOK0910G26NPO				
		30W	BBOK0920G26WPO	BBOK0920G26NPO				
188	MINIFLUX TRANSPARENT	16W	BBOK0910007DPC	BBOK0910007WPC	BBOK0910207WPC	BBOK0910007NPC	BBOK0910207NPC	
		20W	BBOK0910015WPC	BBOK0910015NPC				
		32W	BBOK0920007DPC	BBOK0920007WPC	BBOK0920207WPC	BBOK0920007NPC	BBOK0920207NPC	
		40W	BBOK0920015WPC	BBOK0920015NPC				
		48W	BBOK0930007DPC	BBOK0930007WPC	BBOK0930207WPC	BBOK0930007NPC	BBOK0930207NPC	
		60W	BBOK0930015WPC	BBOK0930015NPC				
79	PLINT	13W	PLT LN2 11	PLT LN3 11				
218	RIGA OPAL	9,6W	MRIG0910G35WFL	MRIG0910G35WFL	MRIG0910G35NFL	MRIG0910G35NSL		
		19,2W	MRIG0920G35WFL	MRIG0920G35WFL	MRIG0920G35NFL	MRIG0920G35NSL		
		28,8W	MRIG0930G35WFL	MRIG0930G35WFL	MRIG0930G35NFL	MRIG0930G35NSL		
		38,4W	MRIG0940G35WFL	MRIG0940G35WFL	MRIG0940G35NFL	MRIG0940G35NSL		
		48W	MRIG0950G35WFL	MRIG0950G35WFL	MRIG0950G35NFL	MRIG0950G35NSL		
		24VDC	MRIG0910035DRE	MRIG0920035DRE	MRIG0930035DRE	MRIG0940035DRE	MRIG0950035DRE	
218	RIGA 3D	8W	MRIG0910G55D3D	MRIG0910G55N3D				
		40W	MRIG0950G55D3D	MRIG0950G55N3D				
112	SALINA	RECESSED TRIMLESS	SAL LW2 61	SAL LW3 61	SAL LW2 63	SAL LW3 63		
		RECESSED TRIM	SAT LW2 61	SAT LN2 61	SAT LW3 61	SAT LN3 61	SAT LW2 63	SAT LN2 63
172	SHARP FRAME	DIMMABLE 1-10V	MPFB8001C29DBG	MPFB8001C29DAN	MPFB8001C29WBG	MPFB8001C29WAN	MPFB8001C29NBG	MPFB8001C29NAN
		DALI	MPFBDA01C29DBG	MPFBDA01C29DAN	MPFBDA01C29WBG	MPFBDA01C29WAN	MPFBDA01C29NBG	MPFBDA01C29NAN
168	SHARP ZOOM	DIMMABLE 1-10V	MPFB8001929DBG	MPFB8001929DAN	MPFB8001929WBG	MPFB8001929WAN	MPFB8001929NBG	MPFB8001929NAN
		DALI	MPFBDA01929DBG	MPFBDA01929DAN	MPFBDA01929WBG	MPFBDA01929WAN	MPFBDA01929NBG	MPFBDA01929NAN
223	SKILLED	2W	BSKL0212G310CS					
161	SLACKLINE	MICRO WALL	BSLM0410G65WAA	BSLM0410G65NAA	BSLM0420G65WAA	BSLM0420G65NAA		
		TRIM	BSLA0110G26WAA	BSLA0110G26NAA	BSLA0120G26WAA	BSLA0120G26NAA	BSLA0130G26WAA	BSLA0130G26NAA
160	SLACKLINE	REGULAR PENDANT	BSLA0310G26WAA	BSLA0310G26NAA	BSLA0320G26WAA	BSLA0320G26NAA		
		REGULAR WALL	BSLA4010G26WAA	BSLA4010G26NAA	BSLA4020G26WAA	BSLA4020G26NAA		
		REGULAR CEILING	BSLA0410G26WAA	BSLA0410G26NAA	BSLA0420G26WAA	BSLA0420G26NAA		
		REGULAR RECESSED	BSLA2110G26WAA	BSLA2110G26NAA	BSLA2120G26WAA	BSLA2120G26NAA		
176	TRACK	CEILING, PENDANT	MTRK0110BI	MTRK0110NE	MTRK0120BI	MTRK0120NE	MTRK0130BI	MTRK0130NE
		RECESSED	MTRK0310BI	MTRK0310NE	MTRK0320BI	MTRK0320NE	MTRK0330BI	MTRK0330NE
		CEILING, PENDANT	MTRK0210BI	MTRK0210NE	MTRK0220BI	MTRK0220NE	MTRK0230BI	MTRK0230NE

pag	product	variation	codes					
		RECESSED	MTRK0410BI	MTRK0410NE	MTRK0420BI	MTRK0420NE	MTRK0430BI	MTRK0430NE
70	VULCANO	30°	VUL LW3 82	VUL LN3 82				
212	WALKBY	4W	MWBY4101038WGA					
212	WALKBY PLUS	8W	MWBY41P1038WGA					
198	WALKLINE	0,5M	BWLK0205G26NAA	BWLK0205G260AA				
		1M	BWLK0210G26NAA	BWLK0210G260AA				
		1,5M	BWLK0215G26NAA	BWLK0215G260AA				
		2M	BWLK0220G26NAA	BWLK0220G260AA				
200	WALKLINE WALL WASHER	0,5M	BWLK0205226WAA	BWLK0205226NAA				
		1M	BWLK0210226WAA	BWLK0210226NAA				
		2M	BWLK0220226WAA	BWLK0220226NAA				
206	WALKWAY	1,2W	BLUX02012170CS	BLUX0201217WCS				

pag	product	variation	codes									
16	ZIRKOL C 1m	downlight	BZRC1610G15DDBO	BZRC1610G15DNE	BZRC1610G15DOR	BZRC1610G15WBO	BZRC1610G15WNE	BZRC1610G15WOR	BZRC1610G15NBO	BZRC1610G15NNE	BZRC1610G15NOR	
		up-downlight	BZRC1710G15DDBO	BZRC1710G15DNE	BZRC1710G15DOR	BZRC1710G15WBO	BZRC1710G15WNE	BZRC1710G15WOR	BZRC1710G15NBO	BZRC1710G15NNE	BZRC1710G15NOR	
17	ZIRKOL C 1,5m	downlight	BZRC1615G15DDBO	BZRC1615G15DNE	BZRC1615G15DOR	BZRC1615G15WBO	BZRC1615G15WNE	BZRC1615G15WOR	BZRC1615G15NBO	BZRC1615G15NNE	BZRC1615G15NOR	
		up-downlight	BZRC1715G15DDBO	BZRC1715G15DNE	BZRC1715G15DOR	BZRC1715G15WBO	BZRC1715G15WNE	BZRC1715G15WOR	BZRC1715G15NBO	BZRC1715G15NNE	BZRC1715G15NOR	
19	ZIRKOL C 2m	downlight	BZRC1620G15DDBO	BZRC1620G15DNE	BZRC1620G15DOR	BZRC1620G15WBO	BZRC1620G15WNE	BZRC1620G15WOR	BZRC1620G15NBO	BZRC1620G15NNE	BZRC1620G15NOR	
		up-downlight	BZRC1720G15DDBO	BZRC1720G15DNE	BZRC1720G15DOR	BZRC1720G15WBO	BZRC1720G15WNE	BZRC1720G15WOR	BZRC1720G15NBO	BZRC1720G15NNE	BZRC1720G15NOR	
20	ZIRKOL C 3m	downlight	BZRC1630G15DDBO	BZRC1630G15DNE	BZRC1630G15DOR	BZRC1630G15WBO	BZRC1630G15WNE	BZRC1630G15WOR	BZRC1630G15NBO	BZRC1630G15NNE	BZRC1630G15NOR	
		up-downlight	BZRC1730G15DDBO	BZRC1730G15DNE	BZRC1730G15DOR	BZRC1730G15WBO	BZRC1730G15WNE	BZRC1730G15WOR	BZRC1730G15NBO	BZRC1730G15NNE	BZRC1730G15NOR	
21	ZIRKOL C 5m	downlight	BZRC1650G15DDBO	BZRC1650G15DNE	BZRC1650G15DOR	BZRC1650G15WBO	BZRC1650G15WNE	BZRC1650G15WOR	BZRC1650G15NBO	BZRC1650G15NNE	BZRC1650G15NOR	
		up-downlight	BZRC1750G15DDBO	BZRC1750G15DNE	BZRC1750G15DOR	BZRC1750G15WBO	BZRC1750G15WNE	BZRC1750G15WOR	BZRC1750G15NBO	BZRC1750G15NNE	BZRC1750G15NOR	
22	ZIRKOL S 1,5x1,5m	downlight	BZRC1606G15DDBO	BZRC1606G15DNE	BZRC1606G15DOR	BZRC1606G15WBO	BZRC1606G15WNE	BZRC1606G15WOR	BZRC1606G15NBO	BZRC1606G15NNE	BZRC1606G15NOR	
		up-downlight	BZRC1712G15DDBO	BZRC1712G15DNE	BZRC1712G15DOR	BZRC1712G15WBO	BZRC1712G15WNE	BZRC1712G15WOR	BZRC1712G15NBO	BZRC1712G15NNE	BZRC1712G15NOR	
24	ZIRKOL S 2x2m	downlight	BZRC1608G15DDBO	BZRC1608G15DNE	BZRC1608G15DOR	BZRC1608G15WBO	BZRC1608G15WNE	BZRC1608G15WOR	BZRC1608G15NBO	BZRC1608G15NNE	BZRC1608G15NOR	
		up-downlight	BZRC1716G15DDBO	BZRC1716G15DNE	BZRC1716G15DOR	BZRC1716G15WBO	BZRC1716G15WNE	BZRC1716G15WOR	BZRC1716G15NBO	BZRC1716G15NNE	BZRC1716G15NOR	
25	ZIRKOL S 3x2m	downlight	BZRC1610G15DDBO	BZRC1610G15DNE	BZRC1610G15DOR	BZRC1610G15WBO	BZRC1610G15WNE	BZRC1610G15WOR	BZRC1610G15NBO	BZRC1610G15NNE	BZRC1610G15NOR	
		up-downlight	BZRC1720G15DDBO	BZRC1720G15DNE	BZRC1720G15DOR	BZRC1720G15WBO	BZRC1720G15WNE	BZRC1720G15WOR	BZRC1720G15NBO	BZRC1720G15NNE	BZRC1720G15NOR	
27	ZIRKOL S 4x1,5m	downlight	BZRC1611G15DDBO	BZRC1611G15DNE	BZRC1611G15DOR	BZRC1611G15WBO	BZRC1611G15WNE	BZRC1611G15WOR	BZRC1611G15NBO	BZRC1611G15NNE	BZRC1611G15NOR	
		up-downlight	BZRC1722G15DDBO	BZRC1722G15DNE	BZRC1722G15DOR	BZRC1722G15WBO	BZRC1722G15WNE	BZRC1722G15WOR	BZRC1722G15NBO	BZRC1722G15NNE	BZRC1722G15NOR	
28	ZIRKOL S 4x2m	downlight	BZRC1612G15DDBO	BZRC1612G15DNE	BZRC1612G15DOR	BZRC1612G15WBO	BZRC1612G15WNE	BZRC1612G15WOR	BZRC1612G15NBO	BZRC1612G15NNE	BZRC1612G15NOR	
		up-downlight	BZRC1724G15DDBO	BZRC1724G15DNE	BZRC1724G15DOR	BZRC1724G15WBO	BZRC1724G15WNE	BZRC1724G15WOR	BZRC1724G15NBO	BZRC1724G15NNE	BZRC1724G15NOR	
32	ZIRKOL O 2x1m	downlight	BZRO16A20G15DDBO	BZRO16A20G15DNE	BZRO16A20G15DOR	BZRO16A20G15WBO	BZRO16A20G15WNE	BZRO16A20G15WOR	BZRO16A20G15NBO	BZRO16A20G15NNE	BZRO16A20G15NOR	
		up-downlight	BZRO17A20G15DDBO	BZRO17A20G15DNE	BZRO17A20G15DOR	BZRO17A20G15WBO	BZRO17A20G15WNE	BZRO17A20G15WOR	BZRO17A20G15NBO	BZRO17A20G15NNE	BZRO17A20G15NOR	
33	ZIRKOL O 3x1m	downlight	BZRO16A30G15DDBO	BZRO16A30G15DNE	BZRO16A30G15DOR	BZRO16A30G15WBO	BZRO16A30G15WNE	BZRO16A30G15WOR	BZRO16A30G15NBO	BZRO16A30G15NNE	BZRO16A30G15NOR	
		up-downlight	BZRO17A30G15DDBO	BZRO17A30G15DNE	BZRO17A30G15DOR	BZRO17A30G15WBO	BZRO17A30G15WNE	BZRO17A30G15WOR	BZRO17A30G15NBO	BZRO17A30G15NNE	BZRO17A30G15NOR	
35	ZIRKOL O 2,5x1,5m	downlight	BZRO16B25G15DDBO	BZRO16B25G15DNE	BZRO16B25G15DOR	BZRO16B25G15WBO	BZRO16B25G15WNE	BZRO16B25G15WOR	BZRO16B25G15NBO	BZRO16B25G15NNE	BZRO16B25G15NOR	
		up-downlight	BZRO17B25G15DDBO	BZRO17B25G15DNE	BZRO17B25G15DOR	BZRO17B25G15WBO	BZRO17B25G15WNE	BZRO17B25G15WOR	BZRO17B25G15NBO	BZRO17B25G15NNE	BZRO17B25G15NOR	
36	ZIRKOL O 3,5x1,5m	downlight	BZRO16B35G15DDBO	BZRO16B35G15DNE	BZRO16B35G15DOR	BZRO16B35G15WBO	BZRO16B35G15WNE	BZRO16B35G15WOR	BZRO16B35G15NBO	BZRO16B35G15NNE	BZRO16B35G15NOR	
		up-downlight	BZRO17B35G15DDBO	BZRO17B35G15DNE	BZRO17B35G15DOR	BZRO17B35G15WBO	BZRO17B35G15WNE	BZRO17B35G15WOR	BZRO17B35G15NBO	BZRO17B35G15NNE	BZRO17B35G15NOR	
37	ZIRKOL O 4x2m	downlight	BZRO16C40G15DDBO	BZRO16C40G15DNE	BZRO16C40G15DOR	BZRO16C40G15WBO	BZRO16C40G15WNE	BZRO16C40G15WOR	BZRO16C40G15NBO	BZRO16C40G15NNE	BZRO16C40G15NOR	
		up-downlight	BZRO17C40G15DDBO	BZRO17C40G15DNE	BZRO17C40G15DOR	BZRO17C40G15WBO	BZRO17C40G15WNE	BZRO17C40G15WOR	BZRO17C40G15NBO	BZRO17C40G15NNE	BZRO17C40G15NOR	
38	ZIRKOL L 1M	downlight	BZRL1610G15DDBO	BZRL1610G15DNE	BZRL1610G15DOR	BZRL1610G15WBO	BZRL1610G15WNE	BZRL1610G15WOR	BZRL1610G15NBO	BZRL1610G15NNE	BZRL1610G15NOR	
		up-downlight	BZRL1710G15DDBO	BZRL1710G15DNE	BZRL1710G15DOR	BZRL1710G15WBO	BZRL1710G15WNE	BZRL1710G15WOR	BZRL1710G15NBO	BZRL1710G15NNE	BZRL1710G15NOR	
39	ZIRKOL L 2M	downlight	BZRL1620G15DDBO	BZRL1620G15DNE	BZRL1620G15DOR	BZRL1620G15WBO	BZRL1620G15WNE	BZRL1620G15WOR	BZRL1620G15NBO	BZRL1620G15NNE	BZRL1620G15NOR	
		up-downlight	BZRL1720G15DDBO	BZRL1720G15DNE	BZRL1720G15DOR	BZRL1720G15WBO	BZRL1720G15WNE	BZRL1720G15WOR	BZRL1720G15NBO	BZRL1720G15NNE	BZRL1720G15NOR	
42-57	ZIRKOL CUSTOM											

GENERAL INFORMATION

Obiettivo di Nemo Studio è quello di proporre soluzioni tecnologiche all'avanguardia, anche tramite un continuo e costante processo di aggiornamento. Per definizione la tecnologia è mutevole ed in costante evoluzione. Sugeriamo, per assicurare la consultazione delle informazioni più recenti sui prodotti, di verificare quelle disponibili sul nostro website www.nemolighting.com. Questo documento è stato redatto a Maggio 2021. Sostituisce ed aggiorna qualsiasi altra pubblicazione in relazione ai prodotti elencati.

Nemo Studio's goal is to propose cutting-edge technological solutions, also through a constant updating process. By definition, technology is changing and continuously evolving. To ensure the consultation of the latest product data, we recommend referring to the information available on our website www.nemolighting.com. This document was drafted in May 2021. It replaces and updates any other publication in relation to the listed products.

Das Ziel von Nemo Studio ist die Entwicklung von technologischen Lösungen auf dem neuesten Stand, auch durch einen ständigen Aktualisierungsprozess. Die Technik entwickelt sich ständig weiter. Um die aktuellsten Produktunterlagen einzusehen, empfehlen wir, sich auf die Informationen auf unserer Website www.nemolighting.com zu beziehen. Dieses Dokument wurde im Mai 2021 verfasst. Es ersetzt und aktualisiert alle anderen Veröffentlichungen in Bezug auf die aufgeführten Produkte.

L'objectif de Nemo Studio est de proposer des solutions technologiques de pointe, également à travers un processus de mise à jour constante. Par définition, la technologie évolue et change continuellement. Pour garantir la consultation des dernières données produits, nous vous recommandons de vous référer aux informations disponibles sur notre site www.nemolighting.com.

ART DIRECTION AND GRAPHIC DESIGN

Guillaume Bloget and Nemo Studio

PHOTOS

Alberto Strada

Marcello Perego

Enrico Muraro

Mario Ruggiero

LOCATION

Musée départemental de la Préhistoire, Nemours (France)

The cultural and sports center Wangari Maatha, Paris (France)

Private Residence, Milan (Italy)

Palazzo Madama, Turin (Italy)

Showroom Nemo Studio, via Borgonuovo 19, Milan (Italy)

Valextra Showroom, Beijing

SPECIAL THANKS

Musée départemental de la Préhistoire, Nemours (France)

The cultural and sports center Wangari Maatha, Paris (France)

Giovanni Brioschi

EDITION

May 2021

NEMO STUDIO

NEMO STUDIO by ILTI LUCE

Strada Borgata Paradiso, 20
10036 Settimo Torinese - ITALY
Tel. +39 011 765 73 01
nemostudio@nemolighting.com

NEMO GALLERIA MILANO

Corso Monforte 19/A,
20122 Milan
Tel +39 02 970 703 40
monforte@nemolighting.com

NEMO STUDIO MILANO

Via Borgonuovo 19,
20121 Milan
studio@nemolighting.com

NEMO FRANCE

Zac Paris Nord II 13,
Rue de la Perdrix
BP 52352 - 95942
ROISSY CDG Cedex
Tel +33 (0)1 486 300 77
france@nemolighting.fr
nemolighting.com/fra/

NEMO GALERIE PARIS

19, Rue du Bac
75007 Paris
Tel +33 (0) 1 40 20 47 69
ruedubac@nemolighting.fr

NEMO USA

625 Jersey Avenue, Unit 7
New Brunswick, NJ 08901
Tel 800 734 5858
usa@nemolighting.com
nemolighting.com/usa/

NEMO HEAD OFFICE

Viale Brianza, 30,
20823 Lentate s/S - ITALY
Tel +39 0362 166 050 0
info@nemolighting.com

Photometric data and more
information available on our website



[NEMOLIGHTING.COM](https://www.nemolighting.com)

