



GAZZDA

---

# Book Armchair

Product sheet

design by  
**Berin Spahić**



# Book Armchair

## Product facts

### Materials

---

Body	Powder coated steel
Shell	Form-pressed veneer
Seat	Form-pressed veneer / Upholstery
Finish	Transparent lacquer

### Technical features

---

#### Usage

The Book Armchair is suitable for a wide variety of private, public and contract *indoor environments*.

#### Form-pressed veneer

Wooden parts are form-pressed in oak or walnut decorative veneers options (top and bottom veneer layer), while the beech makes constructive inner veneer layers. The Armchair seat is also available as a textile or leather upholstered option. For further information please see Available material pages in this document.

#### Stacking box

Thanks to the stacking box under the seat sheel, the upper chair would not leave marks at the upholstery or veneer surface of the chair below, as it would if the seat spacers are used instead of stacking box. Stacking box is made out of form-pressed veneer as well.

#### Metal base

The light metal base is made from Ø18 mm bent steel tubes. Available in black powder-coated finish with fine structure granulated surface.

#### Gliders

Plastic gliders are attached to the chair legs and are suitable for most private, public and contract flooring options. Felten gliders for sensitive floors available upon request.

#### Wood finish

The wooden parts are available in water-based transparent lacquer finishes.

#### Warranty

5 years

#### Colly quantity

2 pcs

#### Cleaning

Please see [Product](#) or [Material](#) page on our website.

### Notes to consider

---

#### Variations

Natural variations in wood color and surface may occur. Regular maintenance will ensure the wood preserves its authentic beauty and can last for generations.

#### Product changes

Please note that Gazzda reserves the right to alter construction and design without notice.

#### Dimensions (tolerances)

The dimensions shown are indicative, they may vary due to the natural properties of wood, season, or manufacturing processes. Deviations from the specified size may occur, usually no more than 1 cm.

For all additional inquiries regarding Book Chairs please feel free to [contact us](#).

# Book Armchair

Base **Steel**, Wooden parts **Veneer**

Version: 16-1-2024

## Basic info

<b>Design</b>	Berin Spahić
<b>Product size</b>	W: 62, D: 53, H: 83
<b>Packaging</b>	W: 65, D: 58, H: 93
<b>Volume</b>	0,35 m <sup>3</sup>
<b>Net weight</b>	7,4 kg
<b>Gross weight</b>	17,3 kg (2 pcs per packaging)

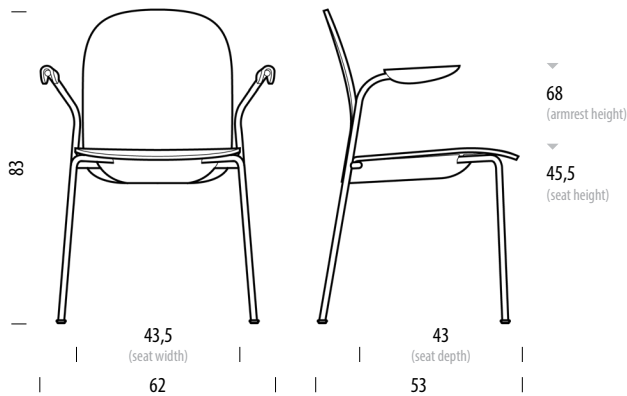

### Item no. 647 / 666

Stackable • Assembled product

Dimensions	Width	Depth	Height
Seat	43,5	43	45,5
Armrest			68

### Stacking

6 chairs on the floor (non-upholstered)  
8 chairs on the Book Trolley (non-upholstered)

### Colors and finishes

Wood parts are lacquered in a transparent lacquer finish.  
Steel legs are powder-coated in Black RAL 9005 color.

# Book Armchair

Base **Steel**, Wooden parts **Veneer**, Seat **Upholstered**

Version: 16-1-2024

## Basic info

<b>Design</b>	Berin Spahić
<b>Product size</b>	W: 62, D: 53, H: 83
<b>Packaging</b>	W: 65, D: 58, H: 93
<b>Volume</b>	0,35 m <sup>3</sup>
<b>Net weight</b>	8,4 kg
<b>Gross weight</b>	19,3 kg (2 pcs per packaging)

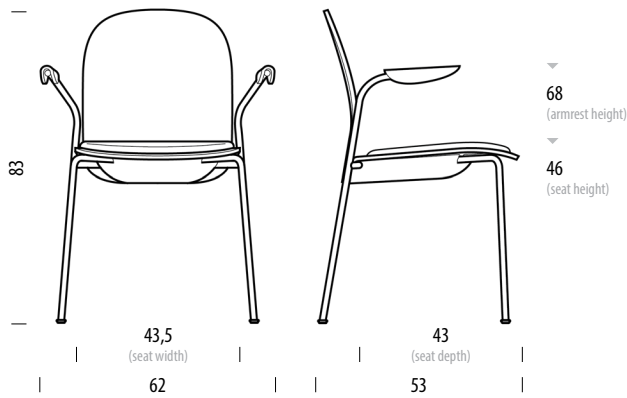

### Item no. 648 / 664

Stackable • Assembled product

Dimensions	Width	Depth	Height
Seat	43,5	43	46
Armrest			68

### Stacking

5 chairs on the floor (upholstered)

7 chairs on the Book Trolley (upholstered)

### Colors and finishes

Wood parts are lacquered in a transparent lacquer finish.

Steel legs are powder-coated in Black RAL 9005 color.

# Book Trolley

Base **Steel**, Seat **Upholstered**

## Basic info

<b>Design</b>	Berin Spahić
<b>Product size</b>	W: 65, D: 56, H: 57
<b>Packaging</b>	W: 68, D: 59, H: 63
<b>Volume</b>	0,25 m <sup>3</sup>
<b>Net weight</b>	20,0 kg
<b>Gross weight</b>	22,5 kg

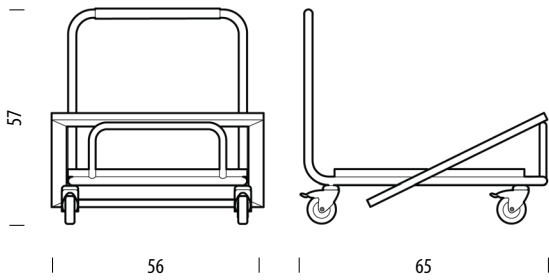

### Item no. 660

Assembled product

Stacking options	Non-upholstered		Upholstered	
	trolley	floor	trolley	floor
Book Armchair	8	6	7	5
Book Side Chair	10	6	9	5

### Wheels

Swivel castors are attached to the base of the trolley allowing unrestricted motion in all directions and a small turning point. The rear castors with brakes ensure a secure grip and minimal danger of rolling.

### Stacking options

For a stacking overview please see the next page.

# Book Armchair

## Stacking overview

Version: 16-1-2024

### Veneer seat (Non-upholstered seat)

Maximum number of veneer armchairs that can be stacked on the floor: **6 chairs**

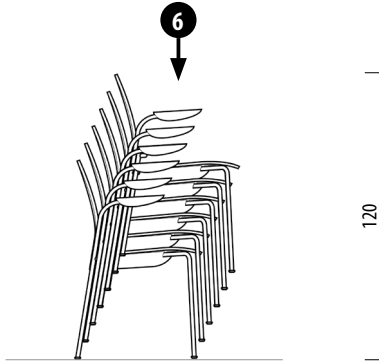

Maximum number of veneer armchairs that can be stacked on the Book Trolley: **8 chairs**

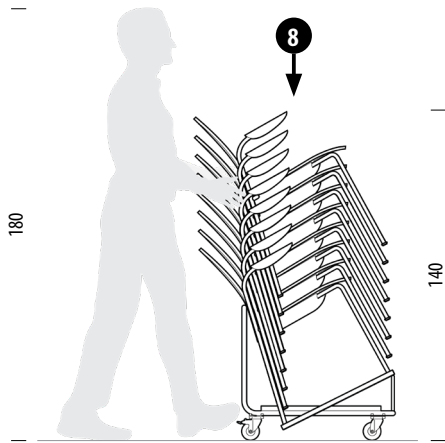

### Upholstered

Maximum number of upholstered armchairs that can be stacked on the floor: **5 chairs**

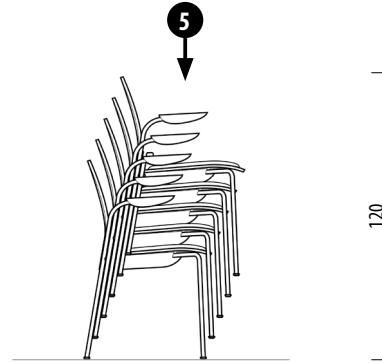

Maximum number of upholstered armchairs that can be stacked on the Book Trolley: **7 chairs**

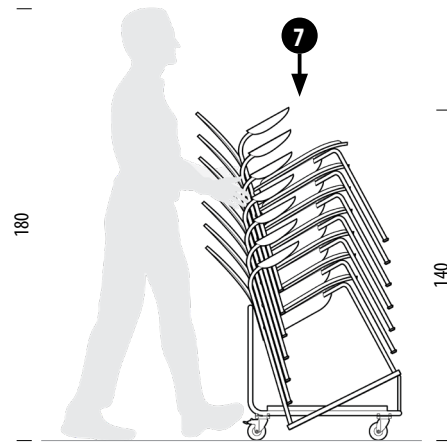

# Book Armchair

## Available materials

Version: 16-1-2024

### Seat and backrest | Form-pressed veneer

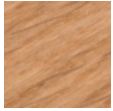

Oak  
Transparent  
Lacquer



Walnut  
Transparent  
Lacquer

### Metal base | Steel

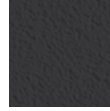

Steel  
Powder-coated  
Black RAL 9005

### Seat | Leather upholstery

#### Dakar - by Leder Reinhard



0500  
Black



1258  
Grey



1436  
Stone



3411  
Nature



2732  
Whisky

#### Deca vegan leather - by Camira



DEC20  
Downing

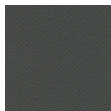

DEC05  
Decimal



DEC03  
Digit

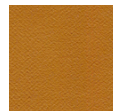

DEC07  
Decapod



DEC14  
Fortune



DEC09  
Tien



DEC11  
Richter



DEC15  
Catenia

### Seat | Fabric upholstery

#### Main line flax - by Camira



MLF16  
Temple



MLF20  
Upminster



MLF02  
Archway



MLF10  
Newbury

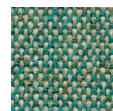

MLF24  
Bayswater

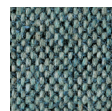

MLF22  
Westminster

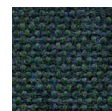

MLF32  
Greenford

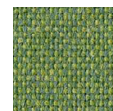

MLF18  
Tufnell



MLF17  
Tooting

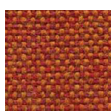

MLF13  
Leyton

# Book Armchair

## Available materials

Version: 16-1-2024

### Era - by Camira

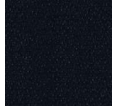
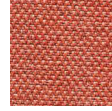
CSE14  
ForwardCSE13  
PresentCSE45  
PromptCSE42  
RangeCSE20  
AeonCSE16  
TimelapseCSE26  
TurnCSE03  
Lifetime

### Relate - by Kvadrat

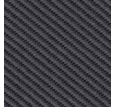

0171

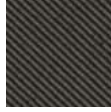

0181

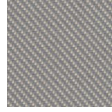

0111

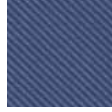

0771



0961

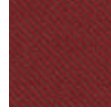

0671



0431

### Remix - by Kvadrat



0753

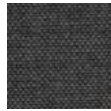

0163

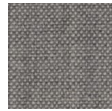

0123



0823

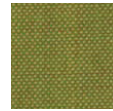

0912



0933



0612

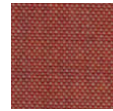

0632



0762

### Oceanic - by Camira

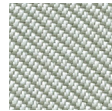
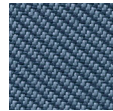
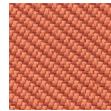
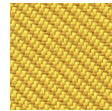
OOC01  
FlotsamOOC08  
BayOOC14  
RiptideOOC13  
PaddleOOC11  
NeptuneOOC05  
CoralOOC07  
Barrier

### Yoredale - by Camira

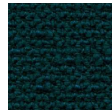
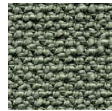
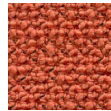
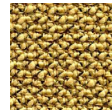
UDA08  
GayleUDA25  
LeyburnUDA17  
RibbleUDA04  
HardwaxUDA02  
KidstoneUDA03  
AskriggUDA05  
Simonstone

### Vidar - by Kvadrat



0182



0133



0222

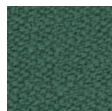

0943

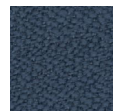

0733

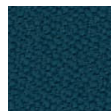

0872

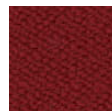

0582



0472