



GAZZDA

Book Armchair

Product sheet

design by
Berin Spahić



Book Armchair

Product facts

Materials

Body	Powder coated steel
Shell	Form-pressed veneer
Seat	Form-pressed veneer / Upholstery
Finish	Transparent lacquer

Technical features

Usage

The Book Armchair is suitable for a wide variety of private, public and contract *indoor environments*.

Form-pressed veneer

Wooden parts are form-pressed in oak or walnut decorative veneers options (top and bottom veneer layer), while the beech makes constructive inner veneer layers. The Armchair seat is also available as a textile or leather upholstered option. For further information please see Available material pages in this document.

Stacking box

Thanks to the stacking box under the seat sheel, the upper chair would not leave marks at the upholstery or veneer surface of the chair below, as it would if the seat spacers are used instead of stacking box. Stacking box is made out of form-pressed veneer as well.

Metal base

The light metal base is made from Ø18 mm bent steel tubes. Available in black powder-coated finish with fine structure granulated surface.

Gliders

Plastic gliders are attached to the chair legs and are suitable for most private, public and contract flooring options. Felten gliders for sensitive floors available upon request.

Wood finish

The wooden parts are available in water-based transparent lacquer finishes.

Warranty

5 years

Colly quantity

2 pcs

Cleaning

Please see [Product](#) or [Material](#) page on our website.

Notes to consider

Variations

Natural variations in wood color and surface may occur. Regular maintenance will ensure the wood preserves its authentic beauty and can last for generations.

Product changes

Please note that Gazzda reserves the right to alter construction and design without notice.

Dimensions (tolerances)

The dimensions shown are indicative, they may vary due to the natural properties of wood, season, or manufacturing processes. Deviations from the specified size may occur, usually no more than 1 cm.

For all additional inquiries regarding Book Chairs please feel free to [contact us](#).

Book Armchair

Base **Steel**, Wooden parts **Veneer**

Version: 16-1-2024

Basic info

Design	Berin Spahić
Product size	W: 62, D: 53, H: 83
Packaging	W: 65, D: 58, H: 93
Volume	0,35 m ³
Net weight	7,4 kg
Gross weight	17,3 kg (2 pcs per packaging)

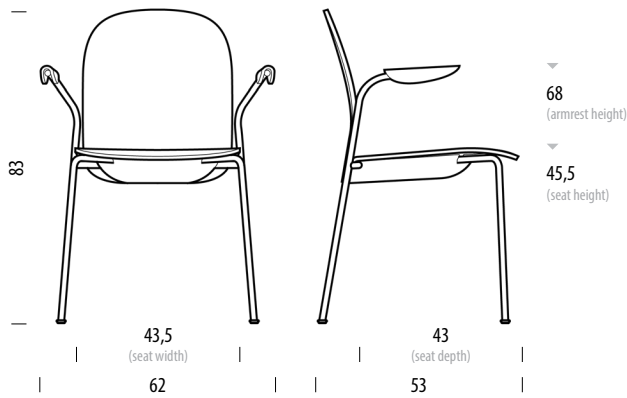

Item no. 647 / 666

Stackable • Assembled product

Dimensions	Width	Depth	Height
Seat	43,5	43	45,5
Armrest			68

Stacking

6 chairs on the floor (non-upholstered)
8 chairs on the Book Trolley (non-upholstered)

Colors and finishes

Wood parts are lacquered in a transparent lacquer finish.
Steel legs are powder-coated in Black RAL 9005 color.

Book Armchair

Base **Steel**, Wooden parts **Veneer**, Seat **Upholstered**

Version: 16-1-2024

Basic info

Design	Berin Spahić
Product size	W: 62, D: 53, H: 83
Packaging	W: 65, D: 58, H: 93
Volume	0,35 m ³
Net weight	8,4 kg
Gross weight	19,3 kg (2 pcs per packaging)

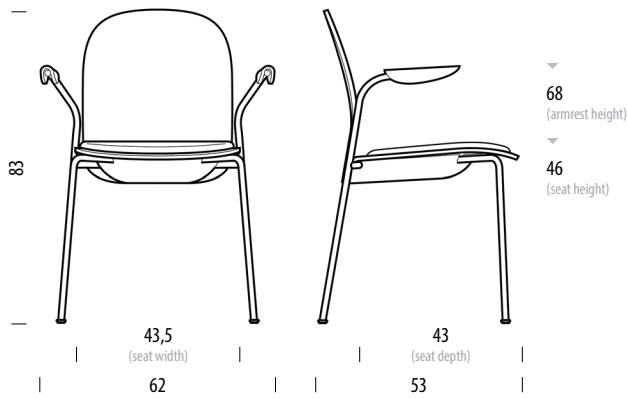

Item no. 648 / 664

Stackable • Assembled product

Dimensions	Width	Depth	Height
Seat	43,5	43	46
Armrest			68

Stacking

5 chairs on the floor (upholstered)

7 chairs on the Book Trolley (upholstered)

Colors and finishes

Wood parts are lacquered in a transparent lacquer finish.

Steel legs are powder-coated in Black RAL 9005 color.

Book Trolley

Base **Steel**, Seat **Upholstered**

Basic info

Design	Berin Spahić
Product size	W: 65, D: 56, H: 57
Packaging	W: 68, D: 59, H: 63
Volume	0,25 m ³
Net weight	20,0 kg
Gross weight	22,5 kg

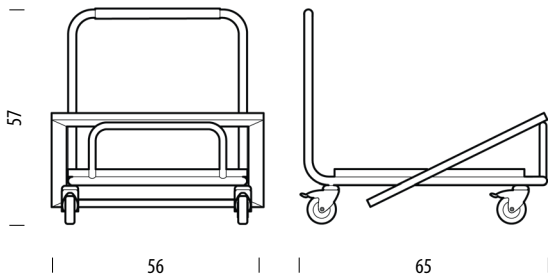

Item no. 660

Assembled product

Stacking options	Non-upholstered		Upholstered	
	trolley	floor	trolley	floor
Book Armchair	8	6	7	5
Book Side Chair	10	6	9	5

Wheels

Swivel castors are attached to the base of the trolley allowing unrestricted motion in all directions and a small turning point. The rear castors with brakes ensure a secure grip and minimal danger of rolling.

Stacking options

For a stacking overview please see the next page.

Book Armchair

Stacking overview

Version: 16-1-2024

Veneer seat (Non-upholstered seat)

Maximum number of veneer armchairs that can be stacked on the floor: **6 chairs**

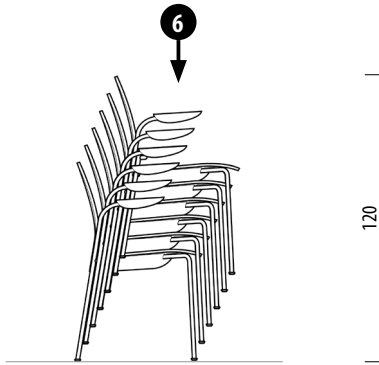

Maximum number of veneer armchairs that can be stacked on the Book Trolley: **8 chairs**

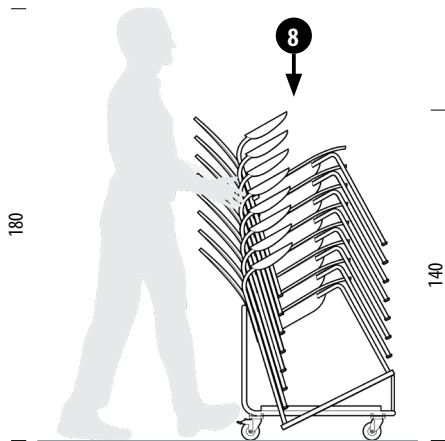

Upholstered

Maximum number of upholstered armchairs that can be stacked on the floor: **5 chairs**

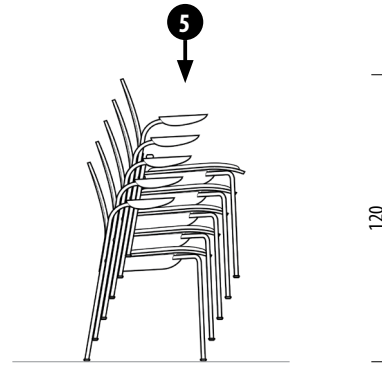

Maximum number of upholstered armchairs that can be stacked on the Book Trolley: **7 chairs**

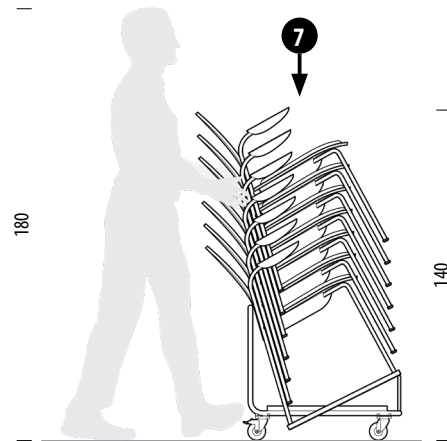

Book Armchair

Available materials

Version: 16-1-2024

Seat and backrest | Form-pressed veneer

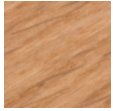

Oak
Transparent
Lacquer



Walnut
Transparent
Lacquer

Metal base | Steel

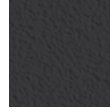

Steel
Powder-coated
Black RAL 9005

Seat | Leather upholstery

Dakar - by Leder Reinhard



0500
Black



1258
Grey



1436
Stone



3411
Nature



2732
Whisky

Deca vegan leather - by Camira



DEC20
Downing

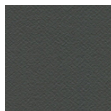

DEC05
Decimal

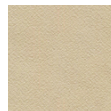

DEC03
Digit

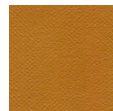

DEC07
Decapod



DEC14
Fortune



DEC09
Tien



DEC11
Richter

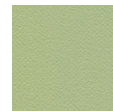

DEC15
Catenia

Seat | Fabric upholstery

Main line flax - by Camira



MLF16
Temple



MLF20
Upminster



MLF02
Archway



MLF10
Newbury

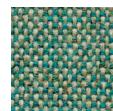

MLF24
Bayswater

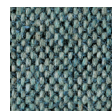

MLF22
Westminster

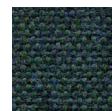

MLF32
Greenford

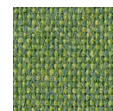

MLF18
Tufnell



MLF17
Tooting

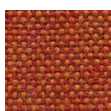

MLF13
Leyton

Book Armchair

Available materials

Version: 16-1-2024

Era - by Camira

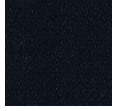
CSE14
ForwardCSE13
PresentCSE45
PromptCSE42
RangeCSE20
AeonCSE16
TimelapseCSE26
TurnCSE03
Lifetime

Relate - by Kvadrat



0171



0181

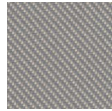

0111



0771



0961

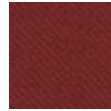

0671

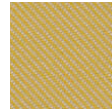

0431

Remix - by Kvadrat

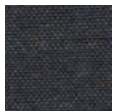

0753



0163

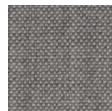

0123



0823



0912



0933



0612



0632



0762

Oceanic - by Camira

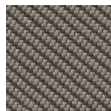
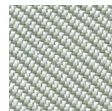
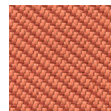
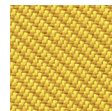
OOC01
FlotsamOOC08
BayOOC14
RiptideOOC13
PaddleOOC11
NeptuneOOC05
CoralOOC07
Barrier

Yoredale - by Camira

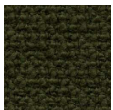
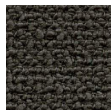
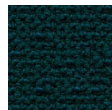
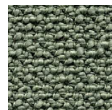
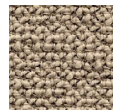
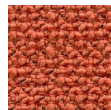
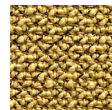
UDA08
GayleUDA25
LeyburnUDA17
RibbleUDA04
HardrawUDA02
KidstoneUDA03
AskriggUDA05
Simonstone

Vidar - by Kvadrat



0182



0133

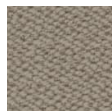

0222

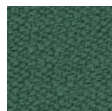

0943

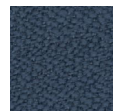

0733

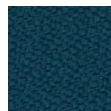

0872

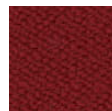

0582



0472