



GAZZDA

Fawn Chair

Product sheet

design by
Salih Teskeredžić



reddot award 2016
winner

Fawn Chair

Product facts

Materials

Body	Solid wood
Finish	Hardwax oil
Seat	Cotton webbing

Technical features

Body

Fawn Chair's body is made out of solid wood. Chair elements are connected with characteristic and visible wedged mortise and tenon joints. Felten gliders are attached to the chair legs and are suitable for most flooring options.

Seat

Lattice-woven cotton webbing is stretched over the seat frame and attached on its inner side to the chair body. For further information please see Available materials and colours page in this document.

Finish

Wooden parts are available in two plant-based Hardwax oil finishes (colours), which retain the wood's natural state, as a white or natural oil.

Cleaning

Please see [Product](#) or [Material](#) page on our website.

Standards and certifications

Fawn Chair fulfils requirements of standards BAS EN 12520:2011 - Furniture - Strength, durability and safety - Requirements for domestic seating, BAS EN 1022:2009 - Furniture - Seating - Determination of stability, BAS EN 1728:2014 + BAS EN 1728/Cor1:2014 - Furniture - Seating - Test methods for the determination of strength and durability.

Notes to consider

Variations

Natural variations in wood color and surface may occur. Regular maintenance will ensure the wood preserves its authentic beauty and can last for generations.

Product changes

Please note that Gazzda reserves the right to alter construction and design without notice.

Dimensions (tolerances)

The dimensions shown are indicative, they may vary due to the natural properties of wood, season, or manufacturing processes. Deviations from the specified size may occur, usually no more than 1 cm.

For all additional inquiries regarding Fawn Chair please feel free to [contact us](#).

Fawn Chair

Base / backrest **Solid wood**, ^{Seat} **Webbing**



Version: 8-1-2024

Basic info

Design	Salih Teskeredžić
Product size	W: 48, D: 48, H: 79
Packaging	W: 51,5, D: 66,5, H: 103
Volume	0,35 m ³
Net weight	4,9 kg
Gross weight	12,7 kg (2 pcs per packaging)

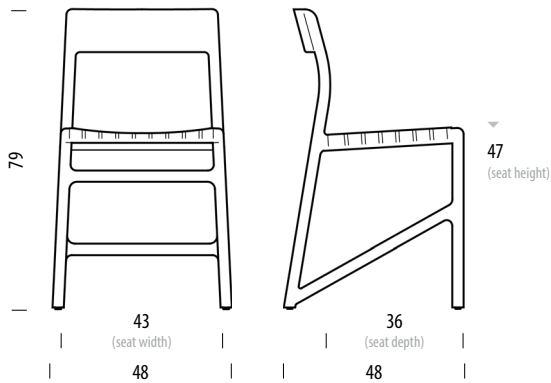

Item no. 083 / 380

Assembled product

Dimensions	Width	Depth	Height
Seat	43	36	47

Selected options

Body

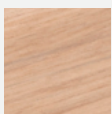

Oiled Oak
1015
White oil

Seat

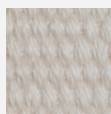

Cotton webbing
2001
White

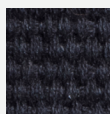

Cotton webbing
2001
Black

Indicated materials and colours are selected by Gazzda as best-selling items and their lead time is shorter than of made-to-order options. Please consult the current price list or our customer service for the lead time of selected options.

For other material options, please see the Available materials section at the end of the product sheet.

Fawn Chair

Available materials

Version: 8-1-2024

Body | Solid wood

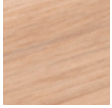

Oiled
1015
White oil

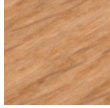

Oiled
1505
Natural oil

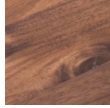

European walnut
1505
Natural oil

Seat | Cotton webbing



2001
White



4555
Black