



GAZZDA

# Fawn Chair

Product sheet

design by  
**Salih Teskeredžić**



reddot award 2016  
winner

# Fawn Chair

## Product facts

### Materials

---

Body	Solid wood
Finish	Hardwax oil
Seat	Cotton webbing

### Technical features

---

#### Body

Fawn Chair's body is made out of solid wood. Chair elements are connected with characteristic and visible wedged mortise and tenon joints. Felten gliders are attached to the chair legs and are suitable for most flooring options.

#### Seat

Lattice-woven cotton webbing is stretched over the seat frame and attached on its inner side to the chair body. For further information please see Available materials and colours page in this document.

#### Finish

Wooden parts are available in two plant-based Hardwax oil finishes (colours), which retain the wood's natural state, as a white or natural oil.

#### Cleaning

Please see [Product](#) or [Material](#) page on our website.

### Standards and certifications

---

Fawn Chair fulfils requirements of standards BAS EN 12520:2011 - Furniture - Strength, durability and safety - Requirements for domestic seating, BAS EN 1022:2009 - Furniture - Seating - Determination of stability, BAS EN 1728:2014 + BAS EN 1728/Cor1:2014 - Furniture - Seating - Test methods for the determination of strength and durability.

### Notes to consider

---

#### Variations

Natural variations in wood color and surface may occur. Regular maintenance will ensure the wood preserves its authentic beauty and can last for generations.

#### Product changes

Please note that Gazzda reserves the right to alter construction and design without notice.

#### Dimensions (tolerances)

The dimensions shown are indicative, they may vary due to the natural properties of wood, season, or manufacturing processes. Deviations from the specified size may occur, usually no more than 1 cm.

For all additional inquiries regarding Fawn Chair please feel free to [contact us](#).

# Fawn Chair

Base / backrest Solid wood, Seat Webbing



reddot award 2016  
winner

Version: 8-1-2024

## Basic info

<b>Design</b>	Salih Teskeredžić
<b>Product size</b>	W: 48, D: 48, H: 79
<b>Packaging</b>	W: 51,5, D: 66,5, H: 103
<b>Volume</b>	0,35 m <sup>3</sup>
<b>Net weight</b>	4,9 kg
<b>Gross weight</b>	12,7 kg (2 pcs per packaging)

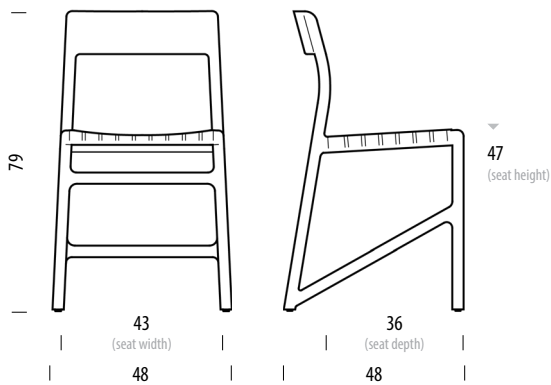

Item no. 083 / 380

Assembled product

Dimensions	Width	Depth	Height
Seat	43	36	47

## Selected options

Body

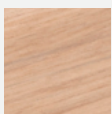

Oiled Oak  
1015  
White oil

Seat

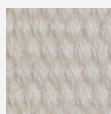

Cotton webbing  
2001  
White

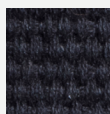

Cotton webbing  
2001  
Black

Indicated materials and colours are selected by Gazzda as best-selling items and their lead time is shorter than of made-to-order options. Please consult the current price list or our customer service for the lead time of selected options.

For other material options, please see the Available materials section at the end of the product sheet.

# Fawn Chair

## Available materials

Version: 8-1-2024

### Body | Solid wood

---

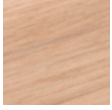

Oiled  
1015  
White oil

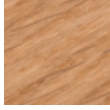

Oiled  
1505  
Natural oil

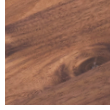

European walnut  
1505  
Natural oil

### Seat | Cotton webbing

---



2001  
White

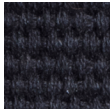

4555  
Black