



PRODUCT SHEET

Androgyne Dining Table, Rectangular
by Danielle Siggerud

Androgyne Dining Table, Rectangular 210 x 100

BY DANIELLE SIGGERUD

The Androgyne Collection pairs natural materials and sculptural forms to striking effect, taking its name from its blend of the masculine and feminine. A bold, confident take on a table, the rectangular iteration amplifies the dimensions of the collection's dining table to grander proportions. The architect-designed piece, crafted with a wood veneer top and base, serves as a community-style table, with room to seat from 8-10 individuals. Available in 210 cm and 280 cm, its artistic silhouette balances function and beauty.

PRODUCT OPTIONS

TABLETOP



NATURAL OAK

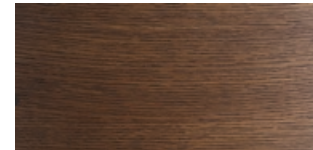

DARK STAINED OAK

OAK BASE



NATURAL OAK



DARK STAINED OAK

Androgyne Dining Table, Rectangular 210 x 100, Natural Oak, by Danielle Siggerud
 Harbour Dining Chair, Dark Stained Oak / Safire 0012, by Norm Architects

Androgyne Dining Table, Rectangular 210 x 100

BY DANIELLE SIGGERUD

TECHNICAL SPECIFICATIONS

PRODUCT TYPE
Dining table

COLLI
1

ENVIRONMENT
Indoor

DIMENSIONS
H: 73 cm / 28,7"
W: 210 cm / 82,7"
D: 100 cm / 43,3"

PRODUCTION PROCESS
CNC-cut and hand-polished stone or CNC-cut MDF with oak veneer. CNC-cut steel fitting with powder coated finish.

COLOUR
Natural oak
Dark stained oak

GLOSS
N / A

MATERIALS
Natural and dark stained oak veneer, MDF, powder coated steel, PA plast glides.

WEIGHT
Tabletop: N / A
Base: N / A

TEST
N / A

CERTIFICATIONS
TSCA title VI compliant

PACKAGING TYPE

Tabletop
Brown box

Base
Brown box

PACKAGING MEASUREMENTS (H x W x D)

Tabletop
N / A

Base
N / A

MATERIALS & MAINTENANCE
Please visit [menuspace.com](https://www.menuspace.com) for materials and care and maintenance instructions.

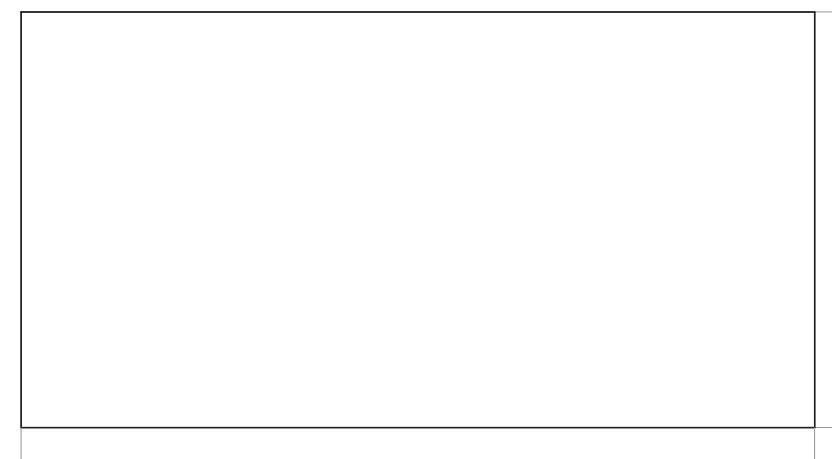

W: 210 cm / 82,7"

D: 110 cm / 43,3"

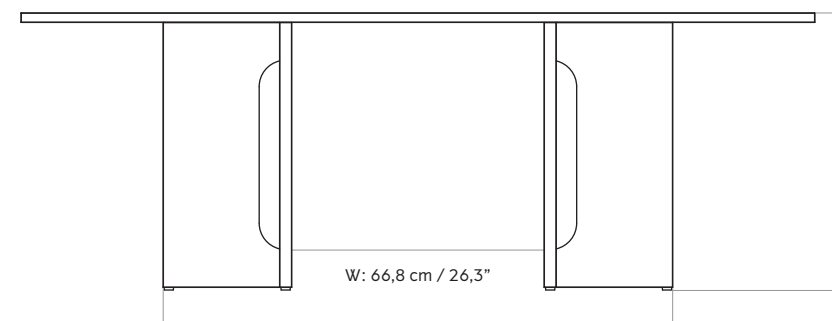

W: 66,8 cm / 26,3"

H: 73,5 cm / 28,9"

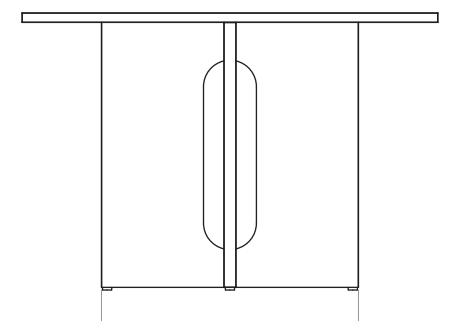

D: 68 cm / 26,8"

Androgyne Dining Table, Rectangular 280 x 110

BY DANIELLE SIGGERUD

The Androgyne Collection pairs natural materials and sculptural forms to striking effect, taking its name from its blend of the masculine and feminine. A bold, confident take on a table, the rectangular iteration amplifies the dimensions of the collection's dining table to grander proportions. The architect-designed piece, crafted with a wood veneer top and base, serves as a community-style table, with room to seat from 8-10 individuals. Available in 210 cm and 280 cm, its artistic silhouette balances function and beauty.

PRODUCT OPTIONS

TABLETOP



NATURAL OAK

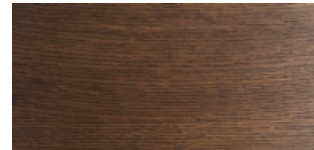

DARK STAINED OAK

OAK BASE



NATURAL OAK



DARK STAINED OAK

Androgyne Dining Table, Rectangular 210 x 100, Natural Oak, by Danielle Siggerud
 Harbour Dining Chair, Dark Stained Oak / Moss 004, by Norm Architects
 Stackable Glasses, by Norm Architects
 Bottle
 Water Bottle, 0,5 L, ClearGlass/Brass, by Norm Architects

Androgyne Dining Table, Rectangular 280 x 110

BY DANIELLE SIGGERUD

TECHNICAL SPECIFICATIONS

PRODUCT TYPE
Dining table

COLLI
1

ENVIRONMENT
Indoor

DIMENSIONS
H: 73 cm / 28,7"
W: 280 cm / 110,2"
D: 110 cm / 43,3"

PRODUCTION PROCESS
CNC-cut and hand-polished stone or CNC-cut MDF with oak veneer. CNC-cut steel fitting with powder coated finish.

COLOUR
Natural oak
Dark stained oak

GLOSS
N / A

MATERIALS
Natural and dark stained oak veneer, MDF, powder coated steel, PA plast glides.

WEIGHT
Tabletop: N / A
Base: N / A

TEST
N / A

CERTIFICATIONS
TSCA title VI compliant

PACKAGING TYPE

Tabletop
Brown box

Base
Brown box

PACKAGING MEASUREMENTS (H x W x D)

Tabletop
N / A

Base
N / A

MATERIALS & MAINTENANCE
Please visit [menuspace.com](https://www.menuspace.com) for materials and care and maintenance instructions.

